



*Scuola Dottorale di Ingegneria  
Sezione di Ingegneria dell'Elettronica Biomedica,  
dell'Elettromagnetismo e delle Telecomunicazioni*

## Multimedia Mobile Communications in Heterogeneous Wireless Networks

*Anna Maria Vegni*

*Advisor:*

*Prof. Alessandro Neri  
University of Roma Tre  
Rome, Italy*

*Co-Advisor:*

*Prof. Thomas D.C. Little  
Boston University  
Boston, MA*

A dissertation submitted to

Roma Tre University  
Department of Applied Electronics

in partial fulfillment of the requirements for the degree of

DOCTOR OF PHILOSOPHY

Rome, March 8<sup>th</sup>, 2010

*To my family*

# Contents

<b>List of Figures</b>	<b>XI</b>
<b>List of Tables</b>	<b>XII</b>
<b>Pubblications</b>	<b>XIII</b>
International Journals . . . . .	XIII
International Conferences . . . . .	XV
Deliverables . . . . .	XVIII
<b>Preface (in Italian)</b>	<b>1</b>
<b>1 Introduction</b>	<b>29</b>
1.1 Abstract . . . . .	29
1.2 Contributions . . . . .	32
<b>2 Vertical Handover</b>	<b>39</b>
2.1 Introduction . . . . .	39
2.2 Overview on Vertical Handover . . . . .	40
2.2.1 IEEE 802.21 Media Independent Handover . . . . .	44
2.2.2 IEEE 802.21 Handover schemes . . . . .	46
2.3 QoS-based Vertical Handover . . . . .	48

2.3.1	No-Reference QoS metrics . . . . .	49
2.3.2	QoS-based Vertical Handoff in 802.21 Networks . . . . .	51
2.3.3	Analytical Model . . . . .	55
2.3.4	Vertical Handover Criteria . . . . .	58
2.3.5	Vertical Handover Algorithm . . . . .	59
2.3.6	Vertical Handover Probability . . . . .	61
2.4	Goodput-based Vertical Handover . . . . .	63
2.4.1	Channel Estimation . . . . .	64
2.4.2	VHO algorithm . . . . .	65
2.4.3	Simulation Results . . . . .	67
2.5	Location-based Vertical Handover . . . . .	72
2.5.1	Handover Initiation . . . . .	73
2.5.2	Handover Assessment . . . . .	76
2.5.3	Handover Algorithm . . . . .	77
2.5.4	Simulation Results . . . . .	78
2.6	Hybrid schemes for Mobile-Controlled handover . . . . .	84
2.6.1	Vertical Handover approaches . . . . .	88
2.6.2	Power-based VHO for Hybrid VHO technique . . . . .	89
2.6.3	Attenuation Map Building and Update . . . . .	90
2.6.4	Power and Location-based (PLB) VHO for non-isotropic cells . . . . .	94
2.7	Considerations about HVHO algorithm . . . . .	96
2.8	Data Rate-based Vertical Handover . . . . .	97

2.8.1	Single-Metric Based VHDF . . . . .	98
2.8.2	Combined-Metric Based VHDF . . . . .	104
2.8.3	VHDF Comparison . . . . .	104
2.9	Probability-based Vertical Handover . . . . .	109
2.9.1	WDP Assessment . . . . .	110
2.9.2	Simulation Results . . . . .	115
2.10	Speed-based Vertical Handover . . . . .	118
2.10.1	Vertical Handover in Vehicular Environment . . . . .	119
2.10.2	Analytical Model . . . . .	121
2.10.3	Speed-Based Vertical Handover . . . . .	125
2.10.4	Simulation Results . . . . .	126
2.10.5	Conclusions . . . . .	130
<b>3</b>	<b>Project: Seamless roaming (mobile-home, mobile-office)</b>	<b>132</b>
3.1	Introduction . . . . .	132
3.2	UPnP Standard . . . . .	135
3.3	UPNP extension with OpenVPN . . . . .	136
3.3.1	Proposed architecture . . . . .	138
3.4	Test-bed Description . . . . .	139
<b>4</b>	<b>VANETs</b>	<b>145</b>
4.1	Introduction . . . . .	145
4.2	Vehicular Ad Hoc NETWORKS . . . . .	147
4.3	IEEE 802.11 p standard . . . . .	150

4.4	Delay Tolerant Networks . . . . .	153
4.5	Vehicular-to-X Protocol . . . . .	157
4.5.1	Protocol Switching Decision metric . . . . .	160
4.5.2	Optimal path selection technique . . . . .	163
4.5.3	Simulation Results . . . . .	169
4.6	Opportunistic vehicular networking . . . . .	177
4.7	Message Propagation Rates with V2X protocol . . . . .	179
4.7.1	Message Propagation Algorithm . . . . .	185
4.7.2	Simulation results . . . . .	189
4.8	Satellite links in VANETs . . . . .	193
4.9	Conclusions . . . . .	197
<b>5</b>	<b>Local Positioning Indoor Services</b>	<b>199</b>
5.1	Introduction . . . . .	199
5.2	TOA approach . . . . .	204
5.3	DOA approach . . . . .	212
5.3.1	Protocol Performance . . . . .	215
<b>6</b>	<b>Acknowledgment</b>	<b>220</b>
	<b>BIBLIOGRAPHY</b>	<b>237</b>

# List of Figures

2.1	Heterogeneous networks scenario. . . . .	41
2.2	MT-Initiated and MT-Canceled Handover. . . . .	47
2.3	Proposed network architecture for QoS-based handoff. . . . .	49
2.4	Theoretical behaviour of QoS-based VHO algorithm. . . . .	63
2.5	Flowchart of the goodput-based VHO algorithm. . . . .	66
2.6	Heterogeneous network environment, composed by a set of UMTS BSs, and Wi-Fi Access Points. The MT is moving at low speed ( <i>i.e.</i> 0.5 m/s). . . . .	68
2.7	Number of VHOs vs. <i>waiting time</i> , [1]. . . . .	70
2.8	Total received bits vs. <i>waiting time</i> , [1]. . . . .	70
2.9	Performance of the proposed VHO algorithm, [1]. . . . .	71
2.10	Flowchart for the proposed Location based Vertical Handover. . . . .	78
2.11	Number of vertical handovers in PB-VHO and LB-VHO cases. . . . .	82
2.12	CRB during a simulated scenario with PB and LB-VHO approaches, for $T_{wait} = 0$ s. . . . .	82
2.13	CRB during a simulated scenario with PB and LB-VHO approaches, for $T_{wait} = 60$ s. . . . .	83
2.14	Finite State Machine for Hybrid Vertical Handover Algorithm. . . . .	89

2.15	PB-VHO Flowchart. . . . .	91
2.16	Anisotropic cell model. . . . .	95
2.17	Decision tree for RSS-VHDF approach. . . . .	100
2.18	Decision tree for DR-VHDF approach. . . . .	103
2.19	Decision tree for C-VHDF approach. . . . .	105
2.20	Average VHO frequency for C-VHDF. . . . .	108
2.21	Average VHO frequency for DR-VHDF. . . . .	108
2.22	Average VHO frequency for RSS-VHDF. . . . .	109
2.23	$WDP$ profile for $g^* < 0$ case. . . . .	113
2.24	VHO Algorithm Finite State Machine. . . . .	115
2.25	Cumulative Received Bits vs. $P_{TH}$ . . . . .	117
2.26	Number of vertical handovers vs. $P_{TH}$ . . . . .	118
2.27	A vehicle moves at constant speed $v$ and follows a Manhattan mobility model. Euclidean geometry is used in combination with the GPS system to compute the <i>cell crossing time</i> . . . . .	123
2.28	Speed Vertical Handover (S-VHO) algorithm. . . . .	126
2.29	Vertical handover simulated scenario for vehicular environment. . . . .	127
2.30	Cumulative Received Bits evaluated for different values of vehicle's speed. ( <i>Left</i> ) Proposed S-VHO algorithm (dark markers), and ( <i>Right</i> ) the related work SPD (white markers). . . . .	128



2.31	Number of Vertical Handovers for different values of vehicle's speed. ( <i>Left</i> ) Proposed S-VHO algorithm (dark markers), and ( <i>Right</i> ) the related work SPD (white markers). Notice the scale difference. . . . .	129
3.1	Home network. . . . .	135
3.2	Virtual UPnP LAN on multiple physical LANs. . . . .	138
3.3	Secure Tunneling between UPnP networks with OpenVPN. . . . .	139
3.4	Remote access to a UPnP network with OpenVPN. . . . .	140
3.5	Testbed scenario: UPnP devices communication across heterogeneous access networks. . . . .	143
3.6	Vertical handoff in a UVPN scenario. . . . .	143
4.1	Data exchange in the VANET environment. . . . .	148
4.2	5.9 GHz DSRC band plan with 10 MHz channels. . . . .	151
4.3	Delay tolerant network (DTN) messaging in VANET scenario. ( <i>a</i> ) Net- work is partitioned, and vehicles are unable to communicate. ( <i>b</i> ) Topology changes, and connectivity is finally achieved. . . . .	154
4.4	Heterogenous wireless network scenario, with different network technologies and overlapping wireless cells. . . . .	159
4.5	Relationship among states and actions, for protocol switching decisions in V2X. . . . .	161
4.6	Multi-hop scenario. . . . .	164
4.7	Data Rate Reduction depends on the distance from a vehicle to the RSU. . . . .	164

4.8	Example of V2V and V2I connectivity in a <i>sparse</i> traffic scenario. . . . .	171
4.9	Optimal path selection technique ( $\alpha = 0$ ) in a <i>dense</i> traffic scenario. . . . .	175
4.10	Optimal path selection technique ( $\alpha = 0$ ) in a <i>sparse</i> traffic scenario. . . . .	177
4.11	Velocity of message propagation in different phases of routing with V2X protocol. . . . .	183
4.12	Forward message propagation with ( <i>left</i> ) V2X protocol, ( <i>right</i> ) traditional opportunistic networking. . . . .	191
4.13	Reverse message propagation with ( <i>left</i> ) V2X protocol, ( <i>right</i> ) traditional opportunistic networking. . . . .	192
4.14	Novel opportunistic networking scheme in VANET scenario, with satellite connectivity for safety applications. . . . .	194
4.15	Forward link End-to-End (E2E) visibility, Rome city vs. East Rome. . . . .	196
4.16	Forward ( <i>a</i> ) uplink, and ( <i>b</i> ) downlink. Backward ( <i>c</i> ) uplink, and ( <i>d</i> ) down- link. . . . .	197
5.1	Packet Forwarding model for TOA mode. . . . .	204
5.2	TOA position estimation method. . . . .	205
5.3	CRLB of the contribution to the standard deviation of the range error pro- duced by the TOA error for a nominal bandwidth of 5 MHz. . . . .	207
5.4	(a) Standard deviation of synchronization error, calculated for $f_e = 5$ MHz. (b) Standard deviation of synchronization error, calculated for $f_e = 20$ MHz.	210
5.5	Map of the Applied Electronics Department and geometry of the simulated MT's path. . . . .	211

5.6 Root mean square position error vs. simulation time. . . . . 211

5.7 TOA timing errors. Grey area represents the uncertain region for MT position. 212

5.8 DOA position estimation method for a pair of LSNs, each of them has a  
LOB from the MT's position. . . . . 213

5.9 Microstrip antenna array for LSN and LSS, 5 cm × 18 cm × 2 cm. . . . . 215

5.10 Location Update Waiting Time vs. number of MTs. . . . . 218

5.11 Number of used LSNs vs. number of MTs. . . . . 218

5.12 Location Probability vs. number of MTs. . . . . 218

5.13 Number of users, for  $\Delta T_{SUPERFRAME} = 5$  ms. . . . . 219

# List of Tables

2.1	Statistic results for PB and LB VHO algorithms. . . . .	80
2.2	Simulated scenario setup. . . . .	105
2.3	Maximum and minimum values of VHO frequency. . . . .	107
4.1	Data Rate Reduction factor versus the path length . . . . .	164
4.2	Connectivity links in a <i>sparse</i> traffic scenario. . . . .	171
4.3	Values of total cost function [s] for vehicles with IC = 1, in a <i>dense</i> traffic scenario. . . . .	173
4.4	Values of total cost function [s] for vehicles with IC=0, in a <i>dense</i> traffic scenario. . . . .	173
4.5	Values of total cost function [s] for vehicles with IC = 1, in a <i>sparse</i> traffic scenario. . . . .	175
4.6	Values of total cost function [s] for vehicles with IC = 0, in a <i>sparse</i> traffic scenario. . . . .	176

# Publications

## International Journals

[Inzerilli *et al.*, 2010] T. Inzerilli, **A.M. Vegni**, A. Neri, and R. Cusani, “A Location and Power Management Based Hybrid Approach for Vertical Handover Decision and Mobile Controlled Connectivity”, (Submitted to) *IEEE Transactions on Vehicular Technology*.

[Vegni *et al.*, 2010] **A.M. Vegni**, T.D.C. Little, and A. Neri, “Vehicle-to-X Protocol for Vehicular Networking”, (Submitted to) *EURASIP Journal on Advances in Signal Processing*, Special Issue on “Vehicular Ad Hoc Networks”.

[Neri *et al.*, 2009] A. Neri, A. Di Nepi, and **A.M. Vegni**, “DOA and TOA Based Localization Services Protocol in IEEE 802.11 Networks”, *Special Issue Wireless Personal Communications Journal*, DOI 10.1007/s11277-009-9719-y.

[Vegni *et al.*, 2008] **A.M. Vegni**, A. Di Nepi, A. Neri, and C. Vegni, “Local Positioning Services on IEEE 802.11 Networks”, *Radioengineering –Proc. of Czech and Slovak Technical Universities and URSI Committees*, Vol.17, No.2, June 2008, pp.42 – 47.

[Neri *et al.*, 2008] A. Neri, **A.M. Vegni**, and A. Di Nepi, “TOA and DOA-based local-

ization services in IEEE 802.11 networks”, *ATTI dell’Istituto Italiano di Navigazione (I.I.N.)*, Anno 2008, No.187, January/February 2008.

## International Conferences

[Vegni, and Little, 2010] **A.M. Vegni**, and T.D.C. Little, “A Message Propagation Algorithm in V2X Protocol”, (Submitted to) *2nd International Workshop on Communication Technologies for Vehicles (Nets4Cars 2010)*, July 21 – 23, 2010, Newcastle, UK.

[Vegni, and Esposito, 2010] **A.M. Vegni**, and F. Esposito, “A Speed-based Vertical Handover Algorithm for VANET”, in *Proc. of 7th International Workshop on Intelligent Transportation (WIT 2010)*, March 23 – 24, 2010, Hamburg, Germany.

[Vegni *et al.*, 2010] **A.M. Vegni**, C. Vegni, and T.D.C. Little, “Opportunistic Vehicular Networks by Satellite Links for Safety Applications”, accepted presentation at *The Fully Networked Car Workshop @ Geneva International Motor Show*, March 3 – 4, 2010, Geneva, Switzerland.

[Vegni *et al.*, 2009 (b)] **A.M. Vegni**, G. Tamea, T. Inzerilli, and R. Cusani, “A Combined Vertical Handover Decision Metric for QoS Enhancement in Next Generation Networks”, *Proc. of 5th IEEE Int. Conference on Wireless and Mobile Computing, Networking and Communications (WiMob 2009)*, October 12 – 14, 2009, Marrakech, Morocco.

[Vegni, and Esposito, 2009] **A.M. Vegni**, and F. Esposito, “Location Aware Mobility Assisted Services for Heterogeneous Wireless Technologies”, in *Proc. of IEEE MTT-S International Microwave Workshop on Wireless Sensing, Local Positioning, and RFID (MTT-S IMWS 2009)*, September 24 – 25, 2009, Cavtat, Croatia.

- [Tamea *et al.*, 2009] G. Tamea, **A.M. Vegni**, T. Inzerilli, and R. Cusani, “A Probability based Vertical Handover Approach to Prevent Ping-Pong Effect”, in *Proc. of 6th International Symposium on Wireless Communication Systems (ISWCS 2009)*, September 7 – 10, 2009, Siena, Italy.
- [Inzerilli *et al.*, 2008] T. Inzerilli, **A.M. Vegni**, A. Neri, and R. Cusani, “A Location-based Vertical Handover algorithm for limitation of the ping-pong effect”, in *Proc. of 4th IEEE Int. Conference on Wireless and Mobile Computing, Networking and Communications (WiMob 2008)*, October 12 – 14, 2008, Avignon, France.
- [Inzerilli, and Vegni, 2008] T. Inzerilli, and **A.M. Vegni**, “A reactive vertical handover approach for WiFi-UMTS dual-mode terminals”, in *Proc. of 12th Annual IEEE Int. Symposium on Consumer Electronics (ISCE 2008)*, April 14 – 16, 2008, Vilamoura, Portugal.
- [Vegni *et al.*, 2008 (a)] **A.M. Vegni**, M. Carli, A. Neri, and G. Ragosa, “QoS-based vertical handoff in heterogeneous networks”, in *Proc. of 10th Int. Symposium on Wireless Personal Multimedia Communications (WPMC 2007)*, December 3 – 6, 2007, Jaipur, India.
- [Vegni *et al.*, 2007 (b)] **A.M. Vegni**, A. Di Nepi, and A. Neri, “DOA versus TOA based localization services in IEEE 802.11 networks”, in *Proc. of 10th Int. Symposium on Wireless Personal Multimedia Communications (WPMC 2007)*, December 3 – 6, 2007, Jaipur, India.
- [Bosco *et al.*, 2007] P.G. Bosco, T. Inzerilli, M. Leo, and **A.M. Vegni**, “Extended UPnP



architecture for emergency applications”, in *Proc. of Wireless Rural Emergency Communications Conference (WRECOM 2007)*, October 1 – 3, 2007, Rome, Italy.

[Vegni *et al.*, 2007] **A.M. Vegni**, A. Di Nepi, A. Neri, and C. Vegni, “Localization services on IEEE 802.11 Networks”, in *Proc. of 19th Int. Conference on Applied Electromagnetics and Communications (ICECom 2007)*, September 24-26, 2007, Dubrovnik, Croatia.

[Vegni, and Di Nepi, 2007] **A.M. Vegni**, and A. Di Nepi, “Localization on IEEE 802.11 Networks”, GTTI Riunione Annuale, June 18 – 20, 2007, Rome, Italy.

## Deliverables

- [D.1] PROGETTO: *Seamless roaming tra assetti comunicativi mobili e fissi (mobile-home, mobile-office)*. Deliverable D.1: T. Inzerilli, M. Leo, and **A.M. Vegni**, “Definizione degli scenari di roaming”. Editor: M. Leo, Work Group: University of Rome “Sapienza”, University of Rome “Tor Vergata”, University of “Roma Tre”, Fase 1: Studio e definizione di scenari di roaming. Oggetto: Definizione dettagliata degli scenari di roaming da coprire, delle macro tipologie di terminali fissi e mobili coinvolti, delle tipologie di connettività fisso-mobili coinvolte, dei requisiti di utente (naturalità, preferenze utente) da considerare.
- [D.2] PROGETTO: *Seamless roaming tra assetti comunicativi mobili e fissi (mobile-home, mobile-office)*. Deliverable D.2: T. Inzerilli, M. Leo, **A.M. Vegni**, and R. Cusani, “*Selezione dello scenario tecnologico*”, Version 1.5, November 23, 2007. Editor: T. Inzerilli, Work Group: University of Rome “Sapienza”, University of Rome “Tor Vergata”, University of “Roma Tre”, Fase 1: Studio e definizione degli scenari di roaming. Oggetto: Selezione di uno specifico scenario tecnologico di mercato ritenuto d’interesse per il successivo sviluppo delle tecniche d’integrazione. Note: Aggiornamento della Versione 1.4 di Ottobre 4, 2007, sulla base dei commenti ricevuti da Telecom Italia.
- [D.3] PROGETTO: *Seamless roaming tra assetti comunicativi mobili e fissi (mobile-home, mobile-office)*. Deliverable D.3: T. Inzerilli, M. Leo, and **A.M. Vegni**, “Definizione del dimostratore (schemi a blocchi)”, Version 3, December 21, 2007. Editor: M. Leo,

Work Group: University of Rome “Sapienza”, University of Rome “Tor Vergata”, University of “Roma Tre”, Fase 2: Definizione e progettazione del dimostratore. Oggetto: Definizione, a livello di schemi a blocchi, di un dimostratore relativo allo scenario individuato nel D2. Definizione degli obiettivi finali della dimostrazione, delle verifiche e delle analisi che verranno eseguite su di esso. Definizione delle procedure e degli algoritmi più significativi che si intende realizzare nel dimostratore. Note: Terza versione rivista successivamente ai commenti da Telecom Italia. Storia del documento: Agosto 03, 2007 prima versione con verifica di R. Cusani, Ottobre 25, 2007 seconda versione con verifica di R. Cusani.

[D.4] PROGETTO: *Seamless roaming tra assetti comunicativi mobili e fissi (mobile-home, mobile-office)*. Deliverable D.4: T. Inzerilli, M. Leo, and **A.M. Vegni**, “Tecnologie di localizzazione”, Versione 1, November 15, 2007. Editor: A.M. Vegni, Work Group: University of Rome “Sapienza”, University of Rome “Tor Vergata”, University of “Roma Tre”, Fase 2: Tecnologie di localizzazione. Oggetto: Studio delle tecnologie di localizzazione disponibili in area indoor/outdoor per la fornitura di informazioni di posizione a servizi location-aware e context-aware. Valutazione della precisione offerta in relazione al servizio richiesto ed agli strumenti attualmente disponibili sul mercato. Storia del documento: Ottobre 23, 2007, prima versione con verifica di R. Cusani.

[D.5] PROGETTO: *Seamless roaming tra assetti comunicativi mobili e fissi (mobile-home, mobile-office)*. Deliverable D.5: T. Inzerilli, M. Leo, and **A.M. Vegni**, “Definizione dei requisiti e scelta della piattaforma realizzativa hw/sw”, Version 1, Gennaio 18,

2008. Editor: A.M. Vegni, Work Group: University of Rome “Sapienza”, University of Rome “Tor Vergata”, University of “Roma Tre”, Fase 2: Definizione e progettazione del dimostratore. Oggetto: Definizione dettagliata dei possibili servizi ed analisi dei dati di contesto necessari per la fase di progettazione. Analisi dei requisiti architettonici e studio degli strumenti disponibili per sviluppare le eventuali soluzioni tecnologiche che siano in grado di supportare servizi “context aware”.

[D.6] PROGETTO: *Seamless roaming tra assetti comunicativi mobili e fissi (mobile-home, mobile-office)*. Deliverable D.6: T. Inzerilli, M. Leo, and **A.M. Vegni**, “Definizione dei requisiti e scelta della piattaforma realizzativa hw/sw”, Versione 4, Aprile 01, 2008. Editor: T. Inzerilli. Work Group: University of Rome “Sapienza”, University of Rome “Tor Vergata”, University of “Roma Tre”, Fase 2: Definizione e progettazione del dimostratore. Oggetto: Definizione dei requisiti per il dimostratore. Scelta della piattaforma realizzativa hw/sw, anche tenendo conto di materiale eventualmente già sviluppato in passato e disponibile presso UNIROMA o presso Telecom Italia. Storia del documento: Gennaio 11, 2008 prima versione; Gennaio 22, 2008 seconda versione con verifica di R. Cusani; Febbraio 11, 2008 terza versione con verifica di R. Cusani; Aprile 01, 2008 quarta versione con verifica di R. Cusani.

[D.7] PROGETTO: *Seamless roaming tra assetti comunicativi mobili e fissi (mobile-home, mobile-office)*. Deliverable D.7: T. Inzerilli, M. Leo, and **A.M. Vegni**, “Identificazione di elementi già disponibili e customizzazioni”, Version 1, Gennaio 29, 2008. Editor: M. Leo. Work Group: University of Rome “Sapienza”, University of Rome “Tor Vergata”, University of “Roma Tre”. Fase 4: Sviluppo di una dimostrazione. Oggetto:

Identificazione degli elementi di piattaforma già disponibili e riutilizzabili, e delle eventuali customizzazione da apportare.

[D.8] PROGETTO: *Seamless roaming tra assetti comunicativi mobili e fissi (mobile-home, mobile-office)*. Deliverable D.8: T. Inzerilli, M. Leo, and **A.M. Vegni**, “Progettazione del sistema fisico”, Version 1, November 07, 2007. Editor: M. Leo. Work Group: University of Rome “Sapienza”, University of Rome “Tor Vergata”, University of “Roma Tre”. Fase 4: Sviluppo del dimostratore. Oggetto: Progettazione del sistema fisico nelle sue componenti client - server HW e SW per la gestione automatica del roaming fra i diversi ambienti, la comunicazione VoIP e l’accesso a Internet, l’utilizzo dei trasduttori multimediali, la gestione delle preferenze utente.

[D.9] PROGETTO: *Seamless roaming tra assetti comunicativi mobili e fissi (mobile-home, mobile-office)*. Deliverable D.9: T. Inzerilli, M. Leo, and **A.M. Vegni** “Sviluppo dei moduli SW”, Version 1, January 25, 2008. Editor: M. Leo. Work Group: University of Rome “Sapienza”, University of Rome “Tor Vergata”, University of “Roma Tre”. Fase 4: Sviluppo del dimostratore. Oggetto: Sviluppo dei vari moduli SW da installare sui device “attivi” (ad es., PC, terminali mobili, Home Gateway). Eventuale sviluppo di prototipi di device alternativi a quelli disponibili commercialmente.

[D.10] PROGETTO: *Seamless roaming tra assetti comunicativi mobili e fissi (mobile-home, mobile-office)*. Deliverable D.10: T. Inzerilli, M. Leo, and **A.M. Vegni** “Setup demo e trials”, Version 1, January 22, 2008. Editor: T. Inzerilli. Work Group: University of Rome “Sapienza”, University of Rome “Tor Vergata”, University of “Roma Tre”.

Fase 4: Sviluppo del dimostratore. Oggetto: Setup di una demo e trial in ambienti ristretti. Sviluppo e rilascio delle specializzazioni di piattaforma multimediale e di context awareness.

# Premessa

La ricerca nel campo delle telecomunicazioni, con particolare interesse ai sistemi di trasmissione wireless di nuova generazione, ha ottenuto un importante impulso grazie a nuove esigenze dell'utente, oltre ad una rapida crescita e diffusione delle tecnologie wireless.

La domanda di servizi multimediali per utenti mobili richiede lo sviluppo di nuovi strumenti per la fruizione dei servizi. Le soluzioni tecnologiche devono essere finalizzate a soddisfare la domanda dell'utenza orientata alla fruizione di contenuti servizi multimediali in maniera ubiqua e trasparente su reti eterogenee ed interoperabili.

In un simile scenario l'utente in mobilità deve poter accedere alle proprie risorse remote, in continuità nel tempo e nello spazio. In tale contesto il gruppo DLNA (Digital Living Network Alliance) porta avanti un intenso lavoro di standardizzazione che riunisce le risorse della consumer electronics, delle comunicazioni mobili e di Internet. L'integrazione tra reti eterogenee richiede principalmente di gestire la mobilità ed il roaming in modo sicuro e senza soluzioni di continuità, inclusi gli aspetti relativi alle procedure di autenticazione, autorizzazione e accounting garantendo l'handover verticale, ovvero il passaggio tra reti diverse, come da rete UMTS a WLAN o viceversa.

Inoltre diventa importante consentire all'utente di disporre delle risorse di connettività più adatte sempre ed ovunque egli si trovi, in modalità trasparente (*seamless*), garantendo

un livello di qualità del servizio (QoS) soddisfacente. Occorre pertanto seguire gli spostamenti di un utente, mantenendo attiva ogni sua connessione mediante processi di handover tra reti eterogenee, mantenendo quando possibile lo stesso livello di QoS.

Infine, i sistemi di localizzazione terrestri e satellitari si stanno largamente diffondendo e permettono di fornire servizi intelligenti in contesti di rete pervasiva, assumendo sempre più importanza nelle applicazioni future.

Nel corso degli ultimi anni si è delineato un nuovo profilo utente (sia business che entertainment), che si sposta in diversi ambienti (indoor e outdoor), dotato di innovativi dispositivi wireless (come smartphines, iPhone, Personal Digital Assistant, ecc.), con lo scopo di permettere una completa connettività, facendo accesso a servizi quali Internet, navigazione, video-on-demand, video-streaming, ecc.

Non sempre però si riesce a far fronte a questo tipo di richiesta senza difficoltà; l'accesso senza fili introduce infatti alcuni problemi ancora senza soluzione legati al fatto che gli utenti si possono muovere durante l'erogazione del servizio.

Alcune applicazioni risentono degli spostamenti dell'utente in maniera percepibile dall'utente stesso: tra queste applicazioni particolare attenzione è data alle applicazioni multimediali, come ad esempio il video streaming. Perdite temporanee della connessione, ad esempio dovute al movimento dell'utente tra zone servite da diversi punti di accesso alla rete fissa, possono causare interruzioni nella riproduzione video o audio. Questo avviene perchè nessuno strumento è stato predisposto per la risoluzione di questo particolare problema.



Le applicazioni multimediali non sono le uniche ad essere soggette a queste interruzioni, ma quelle in cui più facilmente ci si può accorgere di questo problema. Per garantire la completa mobilità dell'utente nasce la necessità di un'infrastruttura che garantisca continuità di servizio. L'*handover verticale* si pone quindi come supporto agli utenti mobili, al fine di mantenere attiva l'erogazione di un servizio anche durante i loro spostamenti in ambienti eterogenei.

Parte della tesi è mirata a raccogliere informazioni sui dispositivi di rete in dotazione all'utente in modo da poter adattare l'applicazione stessa alle esigenze specifiche del dispositivo da cui l'utente richiede il servizio.

Di seguito vengono descritti sommariamente i principali argomenti trattati nel Dottorato di Ricerca:

1. *Algoritmi di Handover Verticale*, (VHO) (Capitolo 2) [Inzerilli *et al.*, 2010], [Vegni, and Esposito, 2010], [Vegni *et al.*, 2009 (b)], [Tamea *et al.*, 2009], [Inzerilli *et al.*, 2008], [Inzerilli, and Vegni, 2008], [Vegni *et al.*, 2008 (a)].
2. Progetto “*Seamless roaming tra assetti comunicativi mobili e fissi, (mobile-home, mobile-office)*” [D.1]–[D.10] e [Bosco *et al.*, 2007] (Capitolo 3);
3. *Vehicular Ad Hoc Networks* (VANETs) [Vegni, and Little, 2010], [Vegni, *et al.*, 2010], [Vegni, *et al.*, 2010] (Capitolo 4);
4. *Sistemi di localizzazione in ambienti indoor* [Vegni, and Esposito, 2009], [Neri *et al.*, 2009], [Vegni *et al.*, 2008], [Neri *et al.*, 2008], [Vegni *et al.*, 2007 (b)], [Vegni *et al.*, 2007], [Vegni, and Di Nepi, 2007] (Capitolo 5).

Nel Capitolo 2 vengono descritte alcune tecniche di decisione di handover verticale tra reti wireless eterogenee, con lo scopo di mantenere attiva la fruizione di un servizio utente. Esistono diverse tecniche o criteri che gestiscono il meccanismo di handover verticale, ovvero la commutazione di un servizio attivo da una rete servente verso una rete candidata. La rete servente e quella candidata appartengono a tecnologie differenti.

Aspetto interessante su cui si è concentrata la tesi di Dottorato prevede lo studio e l'ottimizzazione di tecniche di decisione di un handover verticale. Un handover verticale infatti viene iniziato e quindi eseguito quando, in base ad un certo criterio, si ha una decisione positiva di effettuare tale handover da una rete servente ad una rete candidata. Il criterio di decisione risulta pertanto uno degli aspetti più ardui all'interno del processo di decisione di un handover verticale, in quanto non sempre un handover viene correttamente eseguito oppure non risulta essere necessario (ad esempio, quando si passa da una rete servente ad alto bit rate ad una rete a basso bit rate).

Vari criteri di decisione di VHO sono stati trattati in questa tesi, quali la qualità del servizio, la potenza del segnale ricevuto, l'informazione della localizzazione utente, il rapporto segnale-interferenti, la velocità di spostamento e il data rate. La tecnica di VHO gestita da metriche soggettive di Qualità del Servizio (QoS) è stata presentata in [Vegni *et al.*, 2008 (a)]. L'algoritmo di handover verticale tra reti eterogenee (UMTS e Wi-Fi) è basato su metriche di qualità No-Reference. Tecniche di qualità del servizio, sia soggettive che oggettive, sono state utilizzate come criterio di decisione di handover verticale all'interno di un algoritmo applicato in scenari di reti IEEE 802.21, per applicazioni di tipo real-time (ad esempio, streaming video).

L'architettura di rete si basa sullo standard IEEE 802.21. Una nuova entità di rete, definita QoS-based Decision Engine (*QDE*), comunica con il nodo mobile (MN). Ogni rete presente nello scenario considerato ha un *QDE* il quale invia informazioni al MN, relativamente alle condizioni di rete. Le prestazioni di rete vengono valutate da osservazioni effettuate a istanti temporali precedenti.

Il controllo della qualità viene effettuato su due fronti: (i) No Reference (NR) QoS, ovvero qualità del servizio soggettiva; (ii) DiffServ (DS), ovvero parametri di qualità tipici del protocollo DiffServ che prevedono la classificazione dei pacchetti sulla base di certi livelli di qualità, permettendo così una mappatura in differenti classi di flussi di traffico aggregato.

In base alla duplice informazione sulla qualità NR e DS, è noto un certo livello di qualità *Lev*, che dipende dal tipo di servizio che il MN sta utilizzando e dalla rete servente. Il valore di *Lev* viene quindi confrontato con soglie predefinite e permette l'avvio dell'algoritmo di handover verticale.

Quando un terminale mobile si sposta all'interno della propria rete servente (SN), ogni *T* secondi esso effettuerà misure sulla potenza ricevuta e valuterà la distanza dalla sua posizione a quella della stazione base più vicina, presente in SN. Infine, viene effettuata la stima del livello di QoS. I passi principali dell'algoritmo di VHO proposto sono descritti in [Vegni, *et al.* 2007].

Le probabilità di effettuare un handover sono calcolate in base a tre parametri, quali la misura dell'RSS, la distanza e il criterio di QoS. Poiché il fattore QoS rappresenta il principale parametro su cui si basa l'algoritmo proposto, allora, la procedura di handover

può essere iniziata soltanto sulla base del parametro di qualità.

Tecniche di handover verticale di tipo reattivo, controllato direttamente dal terminale mobile, per tanto definite come Mobile Controlled Vertical Handover (MCHO), sono presentate in [Inzerilli e Vegni, 2008], [Inzerilli *et al.*, 2009], [Vegni *et al.*, 2009].

Lo scopo di tali algoritmi è di assicurare continuità del servizio e massimizzare il goodput di rete (ovvero la capacità del terminale mobile di ricevere correttamente pacchetti), limitando l'effetto indesiderato del “*ping-pong*” (ovvero il passaggio repentino da una rete all'altra). Tale effetto è nocivo soprattutto per il risparmio energetico del terminale. Il risparmio della batteria è un fattore da non trascurare durante il meccanismo di handover, poichè numerose procedure di handover possono far diminuire il parametro di *battery life*, ovvero il tempo di autonomia del terminale mobile. Onde evitare tale aspetto, viene introdotto il parametro di *waiting time*, che fissa il minimo intervallo di tempo tra due successive stime di canale. Tale parametro è stato scelto empiricamente, proprio per determinare il miglior compromesso tra la bontà della stima di canale e il risparmio sulla batteria del terminale.

Sono stati ricavati dei risultati simulativi che dimostrano la bontà degli algoritmi proposti. In particolare, è stato trattato come la stima della larghezza di banda del canale e la limitazione della frequenza di vertical handovers possano migliorare le prestazioni di rete, espresse in termini di goodput.

Gli algoritmi MCHO sono utilizzati da terminali dual-mode di tipo Wi-Fi e UMTS, adottando un approccio “reactive”, per limitare la frequenza di handover effettuati. In

[Inzerilli e Vegni, 2008] l'algoritmo proposto si basa sulla stima del goodput come metrica di qualità del canale, prevedendo una fase di "goodput assessment", in cui vengono monitorate le prestazioni di rete.

Ogni volta che un tentativo di connessione ad una delle due reti cade, verrà effettuato un tentativo di connessione verso l'altra rete, dopo un certo periodo di tempo prestabilito, differente per la rete UMTS e Wi-Fi (*waiting time*), il cui scopo è quello di limitare l'effetto indesiderato del "ping-pong". Di conseguenza, maggiore è il valore del *waiting time*, più piccolo sarà il numero di handover verticali.

Nell'ipotesi in cui accada che sia la rete Wi-Fi che UMTS siano disponibili, la scelta tra l'una e l'altra si basa sull'analisi delle prestazioni di rete di entrambe le reti. La stima del goodput viene fatta in base a due tecniche, (i) *Weighted Moving Average* (WMA) ovvero una media pesata degli ultimi  $K$  campioni della quantità di dati ricevuti simultaneamente dalle due interfacce di rete, e (ii) *Exponential Smoothing Average* (ESA) ovvero una media esponenziale.

In generale, l'algoritmo proposto in [Inzerilli e Vegni, 2008] si basa sui seguenti fattori:

1. *Time parameters*. L'effetto "ping-pong" dipende non solo dalla copertura dei rete, ovvero dal numero finito di hotspots, ma anche dai parametri temporali scelti durante l'algoritmo. Questi operano come fattori d'isteresi per limitare la frequenza di handover verticali;
2. *Estimated goodput*. Valutando la stima del goodput istantaneo di una rete rispetto all'altra è possibile effettuare un handover se il goodput stimato nella rete candidata è maggiore rispetto a quello stimato nella rete attualmente servente.

Per tutti gli algoritmi di handover verticale analizzati, le prestazioni sono state valutate in termini di (i) bit totali ricevuti dal terminale mobile, e (ii) numero totale di handover verticali effettuati, durante il tempo di simulazione. Lo scenario di simulazione è stato rappresentato tramite Matlab 7.0, andando a ricreare un ambiente outdoor di reti eterogenee all'interno del quale un utente si sposta in modalità random, alla velocità di 0.5 m/s. Durante il cammino dell'utente, verrà effettuato un certo numero di handover verticali, da Wi-Fi a UMTS, e viceversa. Lo scopo è di mantenere il servizio, al quale l'utente è connesso, durante tutto il percorso. Degradazioni del segnale, ovvero diminuzioni della potenza del segnale ricevuto, comportano un peggioramento della qualità del servizio (ad esempio durante una videochiamata la qualità del video può peggiorare).

Per le simulazioni, è stato considerato uno scenario outdoor eterogeneo ( $2\text{km} \times 2\text{km}$ ), in cui il terminale mobile si sposta, composta da 3 celle UMTS e 30 celle Wi-Fi. La griglia di simulazione è modellata da una mappa di  $400 \times 400$  zone, ciascuna di area  $5 \text{ m}^2$ . Ciascuna cella Wi-Fi e UMTS ha rispettivamente un raggio di 120 m e 600 m. In [Inzerilli, *et al.* 2009] viene presentato un algoritmo di VHO, gestito dall'informazione di localizzazione del terminale mobile. L'algoritmo è definito Location-based Vertical Handover (LB-VHO) e ha lo scopo di limitare l'effetto "*ping-pong*", in quanto un singolo handover verticale è gestito in base alla informazione di localizzazione del terminale mobile. Il confronto di risultati simulati con l'algoritmo presentato in [Inzerilli e Vegni, 2008] mostra che LB-VHO rappresenta un miglior compromesso tra goodput istantaneo e frequenza di VHO, rispetto al precedente lavoro [Inzerilli e Vegni, 2008].

LB-VHO prevede l'utilizzo di terminali mobili dual-mode, con interfacce di rete Wi-

Fi e UMTS. Inoltre, LB-VHO è guidato direttamente dal MT (*mobile-driven*) ovvero le decisioni di commutazione da una rete servente (Serving Network, SN) ad una rete candidata (Candidate Network, CN) sono effettuate direttamente dal terminale e non dalla rete medesima. Ciò comporta una completa decisione di vertical handover che viene promossa in base all'informazione della posizione del MT e alle prestazioni di rete misurate istante per istante.

L'obiettivo dell'algoritmo LB-VHO è di (i) limitare l'effetto *ping-pong* mediante l'introduzione di un ciclo di isteresi durante le decisioni di vertical handover, e (ii) adottare un compromesso tra goodput cumulativo e frequenza di handover verticale.

L'informazione di posizione del MT viene ottenuta mediante tecnologia GPS durante la fase di inizializzazione dell'handover, ovvero quando, in base alla distanza del MT dal centro della cella di una rete candidata, le prestazioni stimate della CN sono migliori rispetto a quelle della SN nella medesima posizione del MT.

Le performance sono state valutate in termini di (i) bit ricevuti cumulativi (CRB), ovvero la quantità di bit ricevuti per tutto il periodo di simulazione; (ii) numero di handover verticali effettuati dall'utente che si sposta nella griglia durante il periodo di simulazione.

Per tali risultati sono stati considerati (i) il valor medio (in Gigabit), (ii) la deviazione standard (in Gigabit) e (iii) l'indice di dispersione, definito come il rapporto tra la deviazione standard e il valor medio. I valori dei tempi di attesa sono stati scelti pari a 0 e 60 s. Si conclude che l'approccio LB comporta una riduzione del CRB tra il 6.5% per *waiting time* pari a 0 s e il 20% per *waiting time* uguale a 60 s. Ciò conferma che la costante del *waiting time* non dovrebbe essere applicata per l'approccio LB per ridurre la frequenza

di handover. I risultati relativi al numero di VHO ottenuti per LB e PB mostrano come la frequenza di VHO con l'algoritmo LB è significativamente più piccola (nell'intervallo [9.65, 3.70]), rispetto a quella ottenuta con l'approccio PB (nell'intervallo [9.15, 329.85]).

In [Inzerilli, *et al.* 2010] è stato sviluppato il modello di un algoritmo di handover verticale ibrido, ottenuto dai precedenti algoritmi PB e LB-VHO.

La decisione di effettuare un handover verticale rappresenta un ruolo molto importante, soprattutto per evitare handover non necessari o inutili. Si definisce “non necessario” un handover in cui un terminale mobile faccia accesso in una rete candidata, per poi uscirvi dopo poco tempo di permanenza. Handover non necessari sono dannosi per le performance di rete, in quanto incrementano inutilmente il traffico di rete, oltre a diminuire le prestazioni della batteria del terminale, con conseguente aumento dell'effetto *ping-pong*.

Lo studio di una *funzione di decisione* di un handover risulta quindi molto importante per limitare il numero di handover non necessari. Viene definita con *VHO Decision Function* (VHDF) una funzione per decidere opportunamente se effettuare un handover. In [Vegni, *et al.* 2009], è illustrato il confronto tra diverse tecniche di decisione alla base della VHDF. Criteri di decisione si basano tradizionalmente su parametri fisici. Approcci “combinati” prevedono un criterio ibrido tra diversi parametri fisici, quali la potenza del segnale ricevuto (RSS) e il data rate (DR).

La funzione di decisione presentata è definita come C-VHDF (*Combined-VHDF*) e si basa su un criterio ibrido tra RSS e DR. C-VHDF è stata confrontata con RSS-VHDF e DR-VHDF, due funzioni di decisione di handover verticale basate rispettivamente sul



parametro RSS e DR. RSS e DR-VHDF rappresentano pertanto delle funzioni di decisione basate su un criterio singolo, quale l’RSS e il DR, rispettivamente.

L’algoritmo alla base di C-VHDF è definito da fasi comuni alle tecniche a singola metrica (RSS e DR-VHDF), quali *first VHO alarm*, *Network discovery*, *power testing*, *Data Rate gain* e *Idle mode*.

La tecnica C-VHDF permette di effettuare un VHO se il “power testing” è verificato e di conseguenza viene assicurato un guadagno di data rate dalla rete candidata. Da ciò segue che la tecnica combinata delle metriche RSS e DR permette una riduzione del numero di handover verticali, pur mantenendo elevate le performance di rete (esprese in termini di bit totali ricevuti).

In [Tamea, *et al.*] viene presentato un algoritmo di handover verticale, basato sulla probabilità di effettuare un handover sbagliato, o non necessario, definita come *Wrong Decision Probability (WDP)*. Si è dimostrato che l’algoritmo basato sulla *WDP* può assicurare un compromesso efficiente tra una massimizzazione delle performance di rete e una diminuzione dell’effetto *ping-pong*.

La *WDP* è valutata attraverso una stima del goodput istantaneo nella rete servente e in quella candidata, (*i.e.*  $GP_{SN}$ ,  $GP_{CN}$ ). Campionando il goodput in intervalli di tempo discreti predefiniti ( $\Delta(t)$ , [s]) e assumendo una variabile temporale discreta  $k$ , è possibile definire un processo stocastico della funzione  $\Delta GP[k]$ . Qualora  $\Delta GP[k]$  risulti positiva, la rete  $i$  con goodput maggiore rispetto alla rete  $j$  dovrebbe essere selezionata dall’algoritmo di handover verticale. Tale soluzione risulta però soggetta a forti instabilità (*i.e.* effetto

*ping-pong*), a causa di variazioni del goodput non predicibili a priori.

La soluzione proposta in [Tamea, *et al.*] prevede l'assunzione di un'approssimazione lineare della funzione densità di probabilità condizionata di  $\Delta GP$ .

In [Vegni e Esposito, 2009] viene presentato un prototipo di terminale mobile multi-interfaccia radio per il supporto del servizio di localizzazione e mobilità in ambienti indoor e outdoor. Entrambi i servizi vengono racchiusi in un unico servizio definito come *Location Aware Mobility Assisted*. Grazie ad un ambiente di reti wireless eterogenee e a dispositivi multi-interfacce, è possibile assistere un utente in mobilità attraverso l'uso delle tecnologie wireless disponibili. Il terminale mobile ha il compito di riconoscere l'ambiente in cui si trova (indoor o outdoor), per cui attivare opportunamente una certa interfaccia radio.

In [Vegni e Esposito, 2009] viene illustrato come il terminale mobile opera in diversi ambienti (indoor e outdoor) e di conseguenza viene descritto l'algoritmo per il supporto del servizio di localizzazione e mobilità in ciascun ambiente. Viene descritto il progetto del prototipo di un dispositivo multi-modale per la gestione della mobilità e del servizio di localizzazione in ambienti indoor e outdoor, con tecnologie di reti eterogenee. Attraverso l'utilizzo di diverse tecnologie radio (quali GPS, UMTS e Wi-Fi) è possibile assistere un utente in mobilità sia in ambienti indoor che outdoor, ottenendo un servizio di seamless connectivity. Il dispositivo mobile opportunamente attiverà le interfacce radio in dotazione: in ambienti outdoor, il servizio di localizzazione è assicurato dalla tecnologia GPS, la cui informazione di localizzazione utilizzata da un algoritmo di handover verticale; in ambienti indoor, il servizio di localizzazione è garantito dalla tecnologia IEEE 802.11a/g, mentre il mobility management è gestito dal medesimo algoritmo di handover verticale per ambienti

outdoor.

In ambienti outdoor, il terminale mobile attiverà l'interfaccia GPS per il servizio di localizzazione e invierà l'informazione di posizione ottenuta ad un opportuno algoritmo di handover verticale per l'assistenza alla mobilità; in ambienti indoor invece il servizio di localizzazione è gestito dall'interfaccia IEEE 802.11, la quale opera anche per il supporto alla mobilità insieme all'interfaccia UMTS.

Argomento comune a tutti gli argomenti di ricerca esposti è l'integrazione delle reti eterogenee e dei relativi servizi offerti per il "management" della mobilità utente.

Sia in scenari outdoor che indoor è possibile assistere un utente in mobilità ed assicurare il mantenimento di un servizio ad esso fruito, mediante algoritmi di handover. L'attività di ricerca si è concentrata nello studio di tecniche di vertical handover tra reti eterogenee che permettano di (i) limitare l'effetto "ping-pong", (ii) effettuare decisioni corrette per la commutazione da una rete all'altra, (iii) massimizzare le prestazioni di rete, (iv) comparare diverse metriche di decisione, (v) definire un prototipo per gli algoritmi di handover verticali proposti.

Il Capitolo 3 illustra e descrive le fasi del Progetto "*Seamless roaming tra assetti comunicativi mobili e fissi (mobile-home, mobile-office)*", iniziato a Novembre 2006 e terminato a Marzo 2008. Tale Progetto prevede il "design" e la realizzazione di tecniche coordinate per connettere dispositivi HW/SW fissi (*home*) e mobili (smartphones, e altri dispositivi di tipo wearable). L'integrazione tra reti eterogenee richiede di gestire la mobilità ed il

roaming in modo sicuro, inclusi gli aspetti relativi alle procedure di autenticazione, autorizzazione e accounting, garantendo l'handover verticale. Diventa importante consentire all'utente di disporre delle risorse di connettività più adatte sempre ed ovunque egli si trovi, in modalità trasparente (*seamless*) e garantendo un livello di qualità del servizio (QoS) soddisfacente. In particolare è stato individuato uno scenario di servizio di riferimento, definito come *Home Asset Management*, che prevede la gestione delle risorse e contenuti in ambiente domestico. In tale ambito, gli obiettivi proposti hanno riguardato la gestione della mobilità ed il roaming, la configurazione automatica della rete (mediante attivazione Virtual Private Network —VPN), il riconoscimento automatico dei servizi (service discovery in area geografica mediante Universal Plug and Play —UPnP), l'adattabilità delle applicazioni al contesto di fornitura del servizio, l'handover verticale (WiFi-UMTS e viceversa), la gestione delle interfacce logiche e la configurazione della topologia di rete, l'utilizzo di terminali smartphone con sistema operativo Windows Mobile 5 e Symbian, la location/context awareness.

Con il termine *Home Asset Management* ci si riferisce ad uno scenario in cui l'utente può gestire le risorse disponibili in casa, includendo sia dispositivi (computer, centraline, stampanti, ecc.) che i contenuti multimediali. In casa un utente si dedica prevalentemente (*i*) a servizi di "entertainment" di vario tipo che comprendono la fruizione di media multimediali (come filmati, foto o videogiochi), e (*ii*) ad attività di gestione dell'ambiente domestico (come il sistema di riscaldamento e telecamere per la videosorveglianza, rese più efficienti e/o efficaci attraverso strumenti ICT (Information and Communication Technology)). Tali attività possono essere eseguite anche da remoto in ufficio. Ad esempio, è possi-

bile anche dall'ufficio interconnettersi a casa per utilizzare media disponibili nell'ambiente domestico o per controllare il proprio ambiente domestico. Questo è possibile se l'ambiente domestico è interconnesso alla rete pubblica tramite dispositivi sicuri, ovvero "residential gateway". Durante il soggiorno in casa o in ufficio l'utente si può trovare a dover gestire una molteplicità di risorse ed è in grado di accedere a servizi anche con elevata interattività.

L'ambiente di casa è caratterizzato da una molteplicità di terminali dispositivi che permettono all'utente di interagire in modo intelligente ed efficiente con l'ambiente. Può anche usufruire facilmente di connessione a larga banda tra dispositivi locali e l'esterno (Internet). In esso si possono distinguere terminali di uso comune quali DVR (Digital Video Recorder), TV/schermi ad alta definizione, PC (Personal Computer), ai quali si aggiungono terminali portatili di tipo laptop, telefonini e palmari interconnessi in un'unica rete domestica di dispositivi.

La rete è accessibile internamente tramite interfacce WLAN (Wireless Local Area Network) ed esternamente tramite rete UMTS (Universal Mobile Telecommunications System) o tramite accesso a larga banda fisso di tipo xDSL (ADSL/HDSL/VDSL), cavo o fibra. La casa è quindi il luogo ove l'utente si trova nel contesto più favorevole per usufruire di media, sia per la disponibilità di risorse vicine e di tempo. Quando l'utente è fuori casa (ambiente outdoor), può ugualmente usufruire di molte risorse se interconnesso al proprio ambiente domestico in modo opportuno (ad esempio con residential gateway) sfruttando sensori di vario tipo, quali telecamere, sensori di temperatura/umidità/gas/illuminazione per il monitoraggio e la gestione dell'ambiente domestico. Le soluzioni per l'intrattenimento digitale personale sono già in grado di consentire la fruizione di contenuti e servizi attraverso stru-

menti che permetteranno di far cooperare semplicemente in modo trasparente i dispositivi presenti nell'ambiente. L'obiettivo è rendere più semplice l'accesso ai diversi contenuti digitali (fotografie, musica, DVD, televisione, radio, Internet) direttamente dagli schermi presenti nell'ambiente con l'utilizzo di un unico dispositivo o di comandi interattivi (voce o gesti). Il "Personal Digital Entertainment" è l'esperienza fruibile da un utente immerso all'interno di un ambiente nel quale i dispositivi cooperano trasparentemente per veicolare i contenuti multimediali e con il quale esso possa interagire in maniera naturale.

Le reti a banda larga e le soluzioni finalizzate alla convergenza delle reti già ora consentono la realizzazione dei nuovi strumenti per la distribuzione contenuti e per l'intrattenimento digitale. Le funzionalità e le capacità di configurazione degli attuali dispositivi mobili e fissi stanno aprendo nuovi scenari nelle modalità di intrattenimento. La maggior diffusione delle soluzioni VoIP, della IPTV, del DVB-H fornisce agli utenti maggiori possibilità. Le tecnologie digitali stanno anche avendo un impatto significativo sulla natura dell'interazione sociale in quanto è già cambiato il modo di comunicare ed organizzare incontri. Le varie soluzioni tecnologiche disponibili stimolano nuovi modelli di interazione nei quali identità reale e virtuale si confondono. Il successo riscosso dai siti di condivisione di audio e video ha consacrato una nuova concezione del web fatta soprattutto di utenti non più semplici fruitori ma anche produttori di contenuti.

Gli utenti utilizzano le reti per interagire attraverso voce, testo e strumenti multimediali. Soprattutto gli strumenti multimediali sono sempre più utilizzati per consentire agli utenti di fruire di servizi finalizzati (*i*) ad applicazioni ludiche e di intrattenimento, come ad esempio i videogiochi; (*ii*) alla condivisione di contenuti multimediali. Il modello del

traffico Internet sta cambiando radicalmente e si sta sviluppando sempre di più un modello bidirezionale con singoli utenti che condividono i propri contenuti multimediali. La condivisione dei media da parte dei singoli appare come la possibilità di poter affermare la presenza della propria identità digitale nel cyber-spazio.

In questo scenario alcune modalità di comunicazione appaiono, in questo momento, prevalenti rispetto ad altre e, alcune di esse, si contraddistinguono per le applicazioni nel campo del divertimento casalingo e personale. In particolare, alcune modalità di servizio possono essere fruite dai “videogiocatori”. I giochi possono essere svolti sia in modalità tradizionale con un avversario virtuale o mediate partite che prevedono la presenza contemporanea di numerosi giocatori on line.

Nel Progetto “Seamless roaming tra assetti comunicativi mobili e fissi (mobile-home, mobile-office)” la gestione della mobilità e del vertical handover sono stati effettuati a livello di sessione con SIP e in tale contesto meccanismi di soft handover sono stati realizzati duplicando temporaneamente una stessa sessione SIP sulle due interfacce di rete in un terminale dual mode (Wi-Fi e UMTS). Il lavoro in ambito IEEE 802.21 è stato inoltre preso in considerazione per la definizione di algoritmi di vertical handover. Infine, l'autenticazione e la cifratura dell'informazione sarà supportata con OpenVPN nei casi di palmari e portatili in roaming, mentre l'UPnP è stato utilizzato sui sistemi operativi considerati per sistemi portatili e fissi. In [Bosco *et al.* 2007] viene descritto il testbed per l'estensione in area geografica del protocollo UPnP.

Nel Capitolo 4 viene trattata l'attività di ricerca nelle reti veicolari, analizzando il

comportamento di tali reti innovative e proponendo soluzioni per la “mobility management” e la limitata connettività che tali reti presentano. Quest’attività di ricerca è stata svolta da Maggio 2009 a Ottobre 2009, presso il Multimedia Communication Laboratory (MCL) del Prof. Thomas D.C. Little, Boston University, Boston MA, USA.

Le reti veicolari rappresentano una particolare area dello scenario *on-the-move*, ovvero un ambiente outdoor in cui l’utente è immerso si sposta a differenti velocità (es. in macchina, in metropolitana, in aeroporto, in cammino per strada, ecc). Durante tutti gli spostamenti che l’utente effettua, indipendentemente dal tempo e dallo spazio, è garantita una fruizione di servizi multimediali in modalità seamless, ovvero trasparente e senza discontinuità del servizio. Lo scenario di mobilità *on-the-move* può essere definito anche come *Infotainment on-the-move*, termine nato dall’unione delle parole information ed entertainment; si indirizza soprattutto sia a manager e uomini d’affari (business men), sia ad utenza entertainment non business.

Le reti veicolari prevedono spostamenti su veicoli, a medie/alte velocità. Immaginando di trascorrere molto tempo in automobile, si può pensare ad un “in-car mobile office”, ovvero un ufficio virtuale che permetta di lavorare *on-the-road*. Un recente sondaggio condotto dalla Consumer Electronics Association ha mostrato che circa il 36% di consumatori si attende di vedere nella propria automobile un sistema di navigazione più intelligente, negli anni avvenire, ove per sistema intelligente s’intende un sistema di navigazione satellitare, un sistema di trasporto intelligente, un sistema di sicurezza elettronico, comunicazione wireless, audio/visual entertainment, telematica. Importanti requisiti utente da garantire riguardano (i) la naturalezza e facilità di accesso ai servizi in movimento, (ii) la sicurezza



e la protezione dei contenuti fruiti attraverso più reti. Per quanto riguarda il primo obiettivo è necessario tra le varie cose limitare l'intervento dell'utente nell'accesso e fruizione dei servizi il più possibile, rendendo in particolare trasparente all'utente il passaggio tra differenti reti wireless, permettendo all'utente di muoversi dove e quando vuole, senza preoccupazioni circa il mantenimento della propria connettività. Per quanto riguarda invece il secondo punto risulta importante dotare l'ambiente di meccanismi ubiqui di autenticazione, cifratura e protezione dei contenuti informativi scambiati.

“You live in a digital home, you work in a digital office, now it's time to complete your integration into the digital world with a digital car” (*Take Your Digital World On The Road* –[www.intel.com](http://www.intel.com)).

Con il termine *digital car* s'intende in generale un veicolo (es. un'automobile) che permette all'utente in viaggio (es. guidatore e/o passeggero) di essere sempre connesso. In automobile infatti un utente può usufruire di tutti quei servizi multimediali, tipici dell'ambiente indoor, senza mai abbandonarli: la mobilità dell'utente non rappresenta più un limite alla propria connettività, bensì rende più esteso l'accesso al multimediale. L'utenza alla quale sono indirizzati servizi multimediali da gestire in mobilità sia di tipo business che entertainment. Nel primo caso, l'utente deve avere la possibilità di collegarsi costantemente al suo server di posta elettronica per controllare importanti email; vuole effettuare una videoconferenza indipendentemente dal luogo in cui si trova e dall'istante di tempo (indipendenza dal vincolo sullo spazio e sul tempo), oppure vuole sentire in alta definizione le sue canzoni preferite di musica classica, sempre in macchina durante i suoi spostamenti.

Tutto ciò ed ancora altro sarà possibile farlo grazie ad una *digital car*, fornita di un

intelligente computer di bordo che interagisce con l'utente ogni volta che egli comanda una funzione da svolgere (interazione vocale). In sistemi più evoluti, l'interazione computer-utente può avvenire non soltanto tramite voce, ma attraverso un accesso di tipo biometrico. Ad esempio, l'utente che entra nella *digital car* può fare accesso a qualsiasi servizio offerto dal computer di bordo, tramite identificazione delle impronte digitali sul volante dell'automobile o sul display del computer. Più semplicemente, il collegamento può avvenire in modalità automatica, tramite connessione Bluetooth tra computer di bordo e terminale mobile posseduto dall'utente. I servizi multimediali offerti da un dispositivo integrato in una *digital car* possono essere fruiti simultaneamente, nello stesso istante di tempo. Ad esempio, è possibile accedere alla rete Internet per controllare la posta elettronica ed intanto memorizzare il nome di una canzone appena ascoltata alla radio, per riascoltarla successivamente in un ambiente differente, come l'home o l'office.

Il computer di bordo opera diverse funzioni, come navigatore satellitare quando lavora con il modulo GPS integrato, come terminale GSM/UMTS, accesso ad Internet mediante GPRS, Wi-Fi e connettività con altri dispositivi Bluetooth. È possibile infatti commutare una telefonata o una videochiamata da un dispositivo cellulare direttamente sul computer di bordo, sul quale display apparirà il volto della persona con la quale si stava parlando. Tutte queste funzioni sono attivabili semplicemente con il touch-screen o l'interazione vocale (o mediante appositi tasti posti sul volante per non distrarre troppo il conducente dalla guida). L'interazione tra terminale mobile e computer di bordo avviene mediante una sincronizzazione periodica, per cui vengono condivise diverse informazioni, come gli impegni della giornata o gli appunti memorizzati, la rubrica telefonica, i contenuti multimediali

o files di diversi formati supportati. Il computer di bordo può rilevare diversi dispositivi mobili (cellulari, palmari, notebook, ecc), ma anche reti remote home o business. Se ad esempio l'utente che sta viaggiando in una digital car vuole essere sicuro di aver inserito l'allarme di casa, dopo essere uscito, basterà che il computer di bordo interrogherà a distanza la rete home circa l'avvenuto inserimento dell'allarme; se la risposta è negativa, il computer avvertirà l'utente (tramite iterazione vocale) non appena egli accenderà la macchina per partire. Le potenzialità di un computer di bordo sono quindi relative alla sua capacità di rendere l'utente in connessione con il mondo esterno in mobilità (erogazione di servizi multimediali). Allontanandosi dal proprio ambiente domestico, home o office, l'utente non dovrà attendere di rientrarvi per accedere a contenuti informativi siti in essi: egli potrà collegarsi tramite il computer di bordo ai dispositivi appartenenti alla rete home o office. Per quanto riguarda l'utenza entertainment, la richiesta di servizi multimediali è sempre più in crescita. L'utente fa accesso a musica, video ed immagini non solo da casa o luoghi pubblici (Internet points, caffetterie, librerie, ecc.) ma anche "on-the-move", dalla propria macchina. Si parla di Infotainment System che assicura comunicazioni in-vehicle, navigazione e digital entertainment. In questo secondo caso, poichè i passeggeri non stanno alla guida dell'automobile (si pensi ad esempio ad ai passeggeri di un taxi) non è necessario per loro interagire localmente con il DSP (Digital Signal Processor), ma basterà spingere un telecomando o toccare direttamente lo schermo del DSP o altre periferiche ad esso collegato (come ad esempio i televisori posti nei sedili posteriori).

I servizi multimediali per utenza entertainment sono audio di alta qualità, video on demand, navigazione Internet, giochi online, download di contenuto multimediale o editing

di fotografie digitali. I passeggeri posteriori possono quindi trascorrere un viaggio, lungo o breve che sia, guardando il proprio programma televisivo preferito o un DVD (Digital Versatile Disc), grazie agli schermi LCD (Liquid Crystal Display) posti dietro i poggiatesta dei sedili anteriori della digital car. L'audio è assicurato o attraverso il sistema multimediale dell'automobile oppure in forma privata mediante cuffie o auricolari. L'*in-car entertainment* può quindi diventare una soluzione che ben sostituisce le ormai vecchie radio AM/FM, le cassette o i CD musicali (Compact Disc): con lo sviluppo di tecnologie audio/video e l'aumento di nuove tecniche di entertainment, le automobili diventeranno veri e propri luoghi in cui poter ascoltare musica di alta qualità o vedere video.

Dal punto di vista più propriamente ingegneristico, le reti VANET (Vehicular Ad-Hoc Network) sono un sottoinsieme delle reti MANET, per questo vengono anche definite con il termine Mobile Ad-Hoc Network for InterVehicle Communications (MANET for IVC). La fondamentale differenza rispetto alle tradizionali reti mobili wireless consiste nell'elevata velocità di spostamento assoluta e relativa dei veicoli, visti come nodi effettivi di rete. Ne consegue che le VANET sono reti caratterizzate da un'alta frequenza di mutazioni topologiche che rendono difficile l'instaurazione di comunicazioni tra i veicoli.

Molte aziende automobilistiche (come la General Motors) stanno investendo su nuove tecnologie e protocolli per il supporto alle comunicazioni interveicolari. Attuali ricerche prevedono veicoli equipaggiati con diverse tecnologie a bordo, come lo standard IEEE 802.11 p, IEEE 802.16 e, GSM/UMTS/HSDPA, Bluetooth, Zigbee, IrDA, ecc. Il mercato automobilistico punta quindi su nuovi veicoli dotati di moderni sistemi di telecomunicazione che permettano la connettività tra veicoli e tra veicoli e l'attuale rete infrastrutturata.

Tra le applicazioni d'interesse nelle reti VANET vi sono le *safety applications* e l'*infotainment*. Nel primo caso situazioni di pericolo (incidenti, interruzioni stradali, ecc.) vengono gestite attraverso la diffusione di messaggi di allerta che possono aiutare i conducenti dei veicoli comuni e di quelli per l'emergenza a prendere decisioni opportune.

Applicazioni di tipo "infotainment" sono rappresentate dalla fruizione di servizi d'informazione (come la ricezione di messaggi pubblicitari per servizi context-aware, o il controllo della posta elettronica e il "browsing on Internet"), insieme a servizi di "entertainment" (come video streaming, video-on-demand, videoconference, ecc.)

Nello specifico, mi sono interessata (*i*) di definire quali tecnologie di telecomunicazioni siano adattabili per la "future car", (*ii*) della descrizione analitica di uno scenario di rete eterogeneo per il supporto delle comunicazioni veicolari, (*iii*) dello sviluppo di un modello analitico che permetta di valutare quale protocollo di comunicazione dia migliori prestazioni (in termini di mantenimento della connettività) ai veicoli connessi in una rete VANET, (*iv*) di definire un algoritmo per una efficiente commutazione tra i diversi protocolli di comunicazioni veicolari.

Tradizionalmente le comunicazioni tra i nodi (veicoli) di una rete VANET avvengono attraverso il protocollo Vehicle-2-Vehicle (V2V), utilizzando la tecnologia Dedicated-Short Range Communication (DSRC). Tali comunicazioni sono possibili qualora due veicoli si trovino in prossimità, entro una distanza spaziale definita.

Situazioni variabili della densità di veicoli in una rete VANET comportano una maggiore difficoltà nell'instaurare e mantenere attiva una connessione tra due veicoli. Si possono

distinguere tre scenari di reti veicolari:

1. *Dense traffic scenario*: in cui i veicoli sono tutti connessi tra di loro;
2. *Sparse traffic scenario*: in cui i veicoli sono parzialmente connessi tra di loro;
3. *Totally disconnected traffic scenario*: in cui i veicoli sono completamente disconnessi tra di loro.

Diversamente, il protocollo Vehicle-to-Infrastructure (V2I) prevede una comunicazione tra un veicolo e un punto di accesso di un'infrastruttura di rete (cellulare o wireless). In generale, i punti di accesso di diverse tecnologie wireless (come il Wi-Fi, UMTS, WiMAX, ecc.) vengono definiti come Road Side Units (RSUs).

La Figura 4.4 mostra lo scenario di riferimento considerato in [Vegni e Little, 2010] e [Vegni *et al.*, 2010], composto da una rete VANET e da un'infrastruttura di reti eterogenee parzialmente sovrapposte. La rete VANET è rappresentata da un'autostrada con due corsie in cui viaggiano diversi veicoli in direzione opposta.

Il comportamento del pattern di mobilità dei veicoli all'interno di una VANET è modellizzato attraverso raggruppamenti di veicoli, definiti come *clusters*. Un cluster definisce un insieme di veicoli che si trovano in intervalli spaziali tali da permettere loro l'instaurazione di una comunicazione diretta. Tale limite spaziale rappresenta l'intervallo radio di connettività.

I messaggi scambiati tra i veicoli sono inoltrati nella rete VANET via V2V (*i*) lungo la stessa direzione di movimento del veicolo sorgente, (*ii*) lungo la direzione opposta rispetto al veicolo sorgente. Ciò dipende in base al cammino tra sorgente e destinatario, al tipo di

messaggio (broadcast, multicast o unicast), e alla densità di veicoli nella rete VANET.

Sebbene il protocollo V2V si basa principalmente sulla tecnica di multihop e di *bridging*, definiti per risolvere il problema di connettività di veicoli disconnessi nelle “reti opportunistiche”, esso non può operare in situazioni di traffico totalmente disconnesso, in cui i veicoli non sono quasi mai nell’intervallo radio di connettività.

L’utilizzo del protocollo V2I può rappresentare una soluzione a tale problema, in quanto in scenari di traffico totalmente disconnesso la comunicazione con RSUs permette l’inoltro di messaggi nella rete VANET.

Il protocollo Vehicular-to-X (V2X) per le reti VANET [Vegni e Little, 2010], [Vegni *et al.*, 2010] si colloca come protocollo per comunicazioni veicolari ibridi, sfruttando le potenzialità di V2V e V2I, opportunisticamente. V2X rappresenta ha lo scopo di permettere comunicazioni veicolari V2V o V2I in maniera intelligente.

Limitazioni dovute alla densità di traffico veicolare, alla velocità dei veicoli e alle tecnologie disponibili *on-board* e dell’ambiente circostante la rete VANET hanno portato all’implementazione di un modello analitico di un protocollo di comunicazioni ibrido, ovvero che opportunamente opera come V2V o V2I.

Il protocollo V2X permette la commutazione da V2V a V2I e viceversa in base a un funzionale definito come *optimum path detection*. Data la natura mutevole del traffico veicolare, il protocollo V2V non sempre riesce ad assicurare connettività tra veicoli, soprattutto nel caso di “totally disconnected traffic scenario”, in cui i veicoli si trovano a distanze maggiori del limite di connettività (*i.e.*  $> 125$  m). Allo stesso modo, in “sparse traffic scenario” solo

i veicoli che si trovano nel radio range di connettività (*i.e.*  $< 125$  m) possono comunicare tra di loro mediante V2V.

Qualora il protocollo V2V non sia garantito o disponibile, V2I può rappresentare una soluzione al problema dell'instaurazione e mantenimento di una connessione veicolare. Inoltre, V2I viene utilizzato anche per servizi che richiedono data rate elevati, come lo streaming video, e per servizi fruibili solo da particolari providers di reti cellulari.

Il protocollo V2I è disponibile a un veicolo quando esso si trova in prossimità di una rete wireless. La presenza di reti wireless limitrofe ad un veicolo è segnalata da un parametro di rete definito come “*Infrastructure Connectivity*” (IC), il cui valore è pari a 1 quando una o più reti wireless sono disponibili; mentre  $IC = 0$  qualora non vi sono reti wireless a cui un veicolo possa fare accesso.

Nel caso in cui un veicolo abbia  $IC = 1$  (ovvero un veicolo rileva la presenza di uno o più RSU posti nella stessa direzione di propagazione del veicolo), esso può sfruttare la connessione della rete infrastrutturata per:

- (a) inviare messaggi all'RSU, il quale li invierà nuovamente dopo un certo intervallo temporale (soprattutto in scenari “sparse” o “totally disconnected traffic”);
- (b) ricevere messaggi dall'RSU, (soprattutto in scenari “sparse” o “totally disconnected traffic”);
- (c) operare come “bridge” al fine di connettere altri veicoli del medesimo cluster all'RSU (soprattutto in scenari “dense” e “sparse traffic disconnected”).

Se un veicolo ha il parametro  $IC = 1$ , allora esso può potenzialmente essere diretta-



mente connesso ad un RSU di una rete wireless limitrofa. Più in generale, un veicolo può trovarsi vicino ad una o più reti wireless ed il parametro IC avrà sempre valore pari a 1. L'Infrastructure Connectivity non fornisce quindi informazioni circa la connettività di un veicolo con una o più reti vicine, ma solo l'informazione che tale veicolo sta transitando all'interno di tali reti. Il valore  $IC = 0$  indica invece che non il veicolo non sta transitando in nessuna rete wireless limitrofa.

In [Vegni, *et al.* 2010] viene descritto il modello analitico del protocollo V2X. La scelta di un veicolo di comunicare via V2V o V2I è stata formulata attraverso una "benefit function" e una tecnica di "optimal path detection". Dai risultati delle simulazioni, si conclude che:

- In scenari di rete "dense" e "sparse", il protocollo V2V risulta preferibile rispetto al V2I, per tutti quei veicoli con  $IC = 1$ ;
- In scenari di rete "dense", V2V è utilizzato per quei veicoli con  $IC = 0$ ;
- In scenari di rete "sparse", V2V è utilizzato per quei veicoli con  $IC = 0$  se il numero di hops è minimo; all'aumentare del numero di hops, il protocollo V2X commuta da V2X a V2I .

L'analisi della propagazione di un messaggio all'interno di una rete VANET, in cui i veicoli comunicano mediante V2X, è stata trattata in [Vegni e Little, 2010], confrontando i risultati simulati con quelli ottenuti con le tradizionali tecniche di forwarding mediante V2V. Le prestazioni hanno mostrato un incremento dello spazio di propagazione del messaggio all'interno della VANET, in quanto un singolo veicolo non è limitato a comunicare solo via V2V, ma può commutare le comunicazioni da V2V a V2I, e viceversa.

Nel Capitolo 5 viene illustrata una tecnica di localizzazione per ambienti indoor, basata sulla tecnologia IEEE 802.11 a/g. Viene descritto un algoritmo di localizzazione che prevede (i) l'introduzione a livello fisico della tecnica TOA (Time Of Arrival), per stimare la posizione di un utente che si sposta all'interno dell'ambiente indoor, e (ii) un protocollo di accesso al mezzo (MAC) per la trasmissione di pacchetti contenenti informazione di localizzazione [Vegni *et al.*, 2007], [Vegni *et al.*, 2008].

L'algoritmo di localizzazione basato su TOA è stato successivamente completato con la tecnica DOA (Direction Of Arrival), confrontando quindi le due modalità implementabili a livello fisico della tecnologia IEEE 802.11 [Neri *et al.*, 2009], [Vegni *et al.*, 2007 (b)]. Il protocollo a livello MAC risulta invece indipendente dalla tecnica di stima di localizzazione considerata (TOA o DOA).

# Chapter 1

## Introduction

### 1.1 Abstract

Nowadays, the evolving wireless and cellular technologies like UMTS, LTE, WLAN, and WiMAX are cooperating in novel overlapping heterogeneous network scenarios. Emerging and preexistent wireless technologies are characterized by different characteristics, access systems, available services and performances (*i.e.* in terms of bandwidth, and cell coverage). For example, UMTS and Wireless LAN networks are complementary solutions to provide broad coverage with low data rates, and high data rates in hot spots, respectively.

In this view, heterogeneous networks for next generation multimedia systems can cooperate together in order to provide seamless mobility support and offer the user with multimedia Quality-of-Service (QoS), inside each access network.

The increasing demand of high QoS user requirements, and novel mobility scenarios (*i.e. on-the-move* business users, *home* and *office* networks, *on-the-move* entertainment, and infomobility, etc.) require (*i*) the users to be connecting to the Internet anytime, and anywhere, and (*ii*) user services and connectivity to be maintained, and kept alive.

For example, multimedia communications require high and constant user perceived QoS levels, specially when users are moving in an heterogeneous network scenario, where wireless connectivity could be affected by disruptions or then loss of quality. Other services like indoor and outdoor localization should be guaranteed when an user is moving and enters an area where positioning services should be required.

Another example represents an user driving his car, and going shopping in a mall. The GPS technology should assist the vehicle in outdoor environment (*i.e.* on the way going to the mall), and when it is approaching the mall, and entering the parking area, it should be assisted by a local positioning service in order to find a parking spot. The GPS technology is limited to outdoor environment, so navigation service should be interrupted in such circumstance.

To this aim, it is necessary to design a mechanism that should manage user mobility, and multimedia and local positioning services. The vertical handover (or handoff) represents a solution for a broad range of mobile devices (*e.g.* Personal Digital Assistant, laptop, smartphones, iPhone, ecc.) with seamless integration of different networks, such as GSM, UMTS, HSDPA, GPS, Wi-Fi, Bluetooth and so on.

Network switching can be requested to maintain user connectivity if the available resources, the channel quality, the consumer preference, or the perceived QoS are below a certain threshold. Handoff policies are based on different metrics, giving an indication of whether or not to perform a handoff. This decision is traditionally made according to RSSI parameter (Received Signal Strength Indication), and channel availability.

A main issue in handoff mechanism is the initialization of the procedure, that can be

performed by the Mobile Terminal (MT) or the Serving Network (SN).

In heterogeneous environments, mobility management is an open issue, specially when mobile node in a wireless network move fast and connections are not always available. This aspect is typical in Vehicular Ad Hoc NETWORKS (VANETs), where mobile nodes are vehicles moving at high speed.

Connectivity in vehicular environment should be fixed by particular communication protocols that exploit both traditional Vehicle-to-Vehicle (V2V), and Vehicle-to-Infrastructure (V2I) connections. Since VANETs are affected by random and fast topology changes, and vehicle's density, communications between vehicles should consider such variable network characteristics.

Moreover, if we address to a VANET with neighboring preexisting wireless and cellular infrastructure, vehicular communications should not be limited to short-range connectivity, but need to be extended to medium and long-range connectivity. This aspect is strongly motivated when vehicles are driving alone in an isolated area, where traditional V2V and V2I protocol are not suitable. In such scenario (*i.e.* emergency and safety scenario) only a global satellite connectivity should be a valid solution to disconnections.

Finally, still in the framework of multi-network environment, we want to address to which services should be available in heterogeneous networks. Localization, and then navigation, service is one of the main services to be guaranteed. While in outdoor environment, localization is well supported by actual Global Positioning Service (GPS), and by next Galileo system, in indoor environments, local positioning service should depend on the

available technology, and represents an open issue. Moreover, the vision of service extension in geographical area between two wireless networks should represent an interesting deal.

## 1.2 Contributions

My Ph.D. thesis deals with mobile and multimedia communications in heterogeneous environments. Specifically, we mainly address to the following aspects:

1. **Vertical Handover management;**
2. **Seamless roaming between heterogeneous wireless networks;**
3. **Mobility and connectivity support in high speed and vehicular environment.**
4. **Localization services in indoor and outdoor environment.**

**Vertical Handover Management:** The Vertical Handover (VHO) mechanism has been investigated on the basis of several different decision criteria (*i.e.* channel and QoS estimation [1], localization information [2], data rate [3], Signal-to-Noise and Interference ratio, and probability approach [4]). Performance comparison has been carried on in order to define which metric represents the more effective in terms of throughput and limitation of unnecessary vertical handovers. Combination and hybrid techniques result as the most useful technique, with the best tradeoff between network performance, and number of network switching occurrences [3].

Vertical Handover techniques have been mainly designed for pedestrian environment [1, 2, 3], and also vehicular scenarios [5], which represent the most common user-cases.

**Seamless roaming between heterogeneous wireless networks:** The increasing requests of seamless connectivity between several wireless networks has led to improve network connectivity for mobile users.

The Project “*Seamless roaming (mobile-home, mobile-office)*” has been developed from November 2006 to March 2008, in collaboration with University of Rome “Sapienza”, University of Rome “Tor Vergata”, and Telecom Italia Mobile (TiLab, Turin). This project has focused on the study and design of advanced techniques for mobility and connectivity management in heterogeneous network scenarios, where users move and need to be always connected. (*i.e.* from home to office, and vice versa). More details have been published in [6].

A middle-ware layer is generally required in order to allow secure and high-quality interconnection of remote network sites supporting a distributed service environment. For example, a typical e-health scenario includes collaborative services for virtual health-care teams (doctors, patients, care team and pharmacy), including telemedicine, management of electronic medical records and automatic diagnosis systems.

Health-care professionals share information on patients through digital equipments and interact with each other and with the patient as in the same physical place, though they might be actually distributed in different remote sites, *i.e.* patient’s or health-care profes-

sional's LAN (Local Area Network).

In a typical service scenario, a body sensor network can be deployed in order to monitor a patient, who is aided by a nurse in her or his home environment and is interconnected with a team of doctors who reside in remote sites.

Another context in which a collaborative framework can be exploited is a disaster recovery scenario, in which, after a flood or an earthquake, the network infrastructure and relevant services become unavailable. In order to rescue people, civil protection teams need to quickly set-up network links and provide various services, including basic communication, environmental monitoring, and medical services.

#### **Mobility and connectivity support in high speed and vehicular environment:**

In vehicular environment where vehicles are driving at different speeds, connectivity management represents a novel issue. Novel real-time application (*i.e.* video-streaming, video-on-demand, online gaming, etc.) are emerging as new services in vehicular scenarios. Vehicles endowed with sophisticated “on-board” equipment communicate with each other, and with the wireless and cellular network infrastructure by means of several network interface cards, *i.e.*, IEEE 802.11 p, UMTS, HSDPA, and so forth. Vehicle-to-Vehicle (V2V) communications are considered challenging, due to the high level of connectivity disruptions, and the unstable nature of the network topologies, and so Vehicle-to-Infrastructure (V2I) communications represent a viable solution to avoid connectivity interruptions, and support wideband Internet applications. V2I communications are however problematic too, since they lack seamless connectivity when, for example, a vehicle is crossing an area with



overlapping wireless networks, and should switch the actual network connection from the current serving to a new candidate network.

A novel protocol for vehicular communications has been proposed in [7]. It addresses to an hybrid mixture between V2V and V2I, and then it is called as “Vehicle-to-X” (V2X) protocol. The main characteristic is how a particular communication protocol (*i.e.* V2V or V2I) is chosen by a vehicle driving on a road. This decision is taken according to a criterion based on the optimal resource utilization (*i.e.* in term of minimum link utilization time). Moreover, V2X exploits both V2V and V2I, so protocol performance is improved, with respect to traditional vehicular communication protocols (*i.e.* V2V, and V2I). Different traffic conditions, and vehicular speeds, depict VANETs as mobile ad hoc networks with random connectivity. V2X is able to find the most appropriate communication protocol, when vehicular density is changing (*i.e.* dense, sparsely and totally disconnected neighborhoods). Performance results have been analyzed in terms of message propagation rates in VANETs with vehicles communicating via V2X. Comparison with traditional opportunistic forward networking scheme has been dealt; V2X reaches high gains for message disseminations [8].

Connectivity issues in VANETs should be based on different and random-nature network conditions, such as the traffic density, the speed, and the local information. The presence of preexisting network infrastructure around the vehicular grid should improve network connectivity, though in rural or isolated areas it is not able to satisfy user requirements. Totally-disconnected scenarios where no wireless networks is available, and

vehicle density is very low, connectivity for isolated vehicles can be guaranteed only by satellite links. For example, a vehicle (called as *isolated vehicle*) is driving alone on the road (*i.e.*, the traffic density reaches the minimum value), and no radio coverage (*e.g.*, no Wi-Fi access points, or cellular base stations). We have proposed in [9] a novel satellite service for safety applications in VANETs, where an isolated vehicle seeks to send an SOS message to any neighboring vehicle to alert about an accident occurred. Particularly, the SOS message (where the vehicle's position is stored) is sent to the satellite in view (*i.e.*, LEO/MEO satellite constellations) by the vehicle (uplink connection). The satellite receives the message, processes the vehicle's position information, and calculates the distance of the source vehicle respect to three/four reference positions. Our technique is then intended to augment short and medium-range communication to bridge isolated vehicles or clusters of vehicles when no other mechanism is available.

Finally, a Vertical Handover technique has been adopted in VANETs, as a novel approach, called as Speed-based Vertical Handover [5]. Traditional vertical handover algorithms based on QoS requirements mostly suggest that a node should switch to a candidate network, whenever its bandwidth is higher than that experienced in the current serving network, in order to improve reception quality. Although this strategy seems reasonable, in vehicular environments, it may fail, due to the speed and the time that the vehicle is going to spend in the new cell.

**Localization services in indoor and outdoor environment:** The location techniques are the basis of a new class of services, called as Location Based Services (LBS), providing appropriate contents to the user, to the right place and in the most simple and rapid way. An increasing number of mobile and smart phones allow people to access the Internet, wherever they are and whenever they want. This new scenario includes a wide range of services based on the possibility to localize and track the user in a location-aided environment, such as emergency and rescue assistance, infomobility, and so on. Reliable and accurate position information of mobile users is necessary by the adoption of the Federal Communications Commission (FCC) regulations to provide Enhanced-911 (E-911) service.

An LBS represents an intersection of three technologies, such as Internet, mobile devices and Geographic Information Systems. Integration of localization services in wireless networks is an open issue, as actual satellite based location systems (*e.g.* GPS) are widely employed in the outdoor environment, but barely used in the indoor one. In this paper, we address the issue of mobile positioning (*i.e.* estimating the location of a MT, moving inside a wireless network).

Our focus is to verify if existing IEEE 802.11 wireless networks can support localization services, specially in environments where satellite signals are too weak. We complemented WLAN networks with location services for indoor environment, without modification on the physical and the MAC layers, and with a low impact in the overall throughput. Our localization protocol uses either TOA (Time Of Arrival) and DOA (Direction Of Arrival) measurements, performed at physical layer. A set of nodes, defined as Localization Supporting Server (LSS) and Localization Supporting Nodes (LSNs), are used to track and

localize a MT. All these nodes located in known fixed positions measure those parameters related to a pre-selected localization algorithm (*i.e.* ToA or DoA mode).

## Chapter 2

# Vertical Handover

### 2.1 Introduction

Mobile communication is increasing popularity due to the availability of low cost portable devices and advanced wireless technology. Moreover, wireless communication and device integration have lead a to new form of distributed computing, the nomadic computing. In a nomadic computing environment, the mobility management is the essential support for roaming users with mobile terminals to permit them to enjoy their services when they move from a cell to another. Multimedia services require not only large bandwidth requirement, but also the possibility of utilization in scenario *on-the-move*. The future 4th Generation of wireless communications will provide seamless mobility support to access to heterogeneous wired and wireless networks. Evolving technologies like UMTS, WLAN, and WiMAX do not present a single global access network but have further increased the heterogeneity of access technologies. Each access technology has different characteristics, in terms of network parameters and values, such as bandwidth (70 Mbit/s for WiMAX, and 9.6 kbit/s for GSM), cell diameter (50 km in LoS for WiMAX, and 100 m for WLAN), or handover

latency (3 s for WLAN and  $50\mu$  s for WiMAX).

Multimedia communications require high and constant user perceived Quality-of-Service (QoS) levels. To this aim, it is necessary to design handover mechanisms between heterogeneous mobile devices (*e.g.* PDA, laptop, smartphones) and seamless integration of different integrated network, such as GSM, UMTS, HSDPA, GPS, Wi-Fi, Bluetooth and so on. In this way, it is possible for a mobile user to switch between different networks, supporting the same services, seamlessly. This process must be performed to adapt to changing access networks and changing environments automatically, with no user participation. So, it requires cross layer design for multimedia communications. Mobile computing becomes more feasible, *e.g.* a mobile user performing a videoconference in UMTS network wants to maintain this service, if the link breaks down, accessing into a Wi-Fi network.

In this Chapter 2, we will introduce the definition of vertical handoff, and will describe how this mechanism works in novel IEEE 802.21 standard. Moreover, we will illustrate different metrics for a vertical handoff decision, each of them is based on a particular criterion (*i.e.* received power level, Signal-to-Noise and Interference Ratio, QoS, and so on).

## 2.2 Overview on Vertical Handover

Handoff (or handover) is the process by which a mobile terminal keeps its connection active when it migrates from the coverage of one network Access Point (AP) to another. Different types of handoffs can occur in wireless overlay networks. Network switching can be performed not only to maintain user connectivity. There are some decision handoff

parameters based on QoS, available resources, channel quality or preference consumer. For example, in GSM network, handoff decision is mainly performed based on a perception of channel quality, reflected by the received signal strength and the availability of resources in neighbor cells. The Base Station (BS) usually measures the quality of the radio link channels used by mobile nodes (MNs) in its service area. It is done periodically so that degradations in signal strength below a prescribed threshold can be detected and handoff to another radio channel or cell can be initiated.

A main classification of handoff process previews *horizontal* and *vertical* handoff (also called as handover). The first approach occurs between the APs of the same network technology, while vertical handover occurs between different APs belonging to different networks. Several kind of vertical handoffs are performed when a mobile nodes moves in an *on-the-move* scenario.

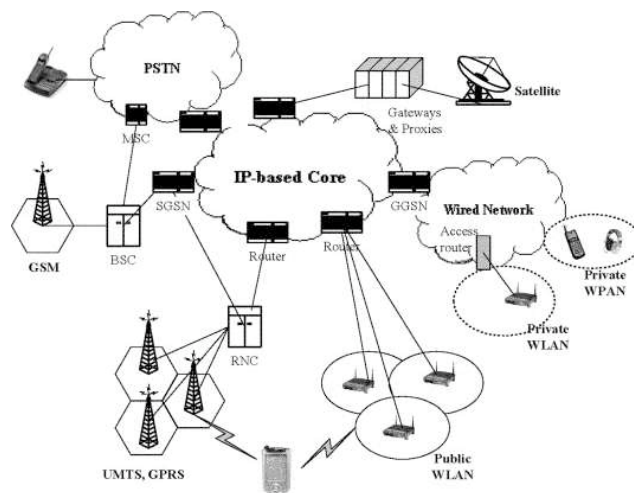

**Figure 2.1:** Heterogeneous networks scenario.

Generally, two main types of handoff are referred as *upward* and *downward* handoffs.

According to Figure 2.1, *upward* vertical handoff is a handoff to a wireless overlay with a larger cell size and generally lower bandwidth per unit area. It makes a mobile device disconnect from a network providing faster but smaller coverage (*i.e.* a WLAN cell) to a new network providing slower but broader coverage. Vice versa, a *downward* vertical handoff is a handoff to a wireless overlay with a smaller cell size, and generally higher bandwidth per unit area: a mobile device performing a downward vertical handoff disconnects from a cell providing broader coverage to one providing limited coverage but higher access speed. In the case of downward vertical handoffs, a link layer trigger can indicate to a mobile device that it is now under the coverage of a new network (*i.e.* a WLAN cell), and the mobile node may wish to execute the handoff.

Downward vertical handoffs may be anticipated or unanticipated, such that a mobile device may already be under the coverage of the new network but may prefer to postpone a handoff based on requirements of the applications running on the mobile node, and may execute a handoff later, being already aware of the coverage status of the new network. Then, a handoff is defined as *hard* if the MT can be associated with only one access point at a time. This configuration is acted in GSM network. On the other hand, in UTRAN a soft handoff occurs when a MT can communicate with more than one base stations during handoff.

Generally, if the MT presents multiple network interfaces, it can simultaneously connect to multiple APs in different networks during soft handoff. Soft handoff may also be referred to as *make-before-break* handoff in which the mobile nodes connection may be created at the target base station before the old base station connection is released. In the case of



hard handoff, the new connection is set up after the old connection has been shutted down (*break-before-make*).

A main issue in handover process is to decide if or when to make handoff, and who performs it. Handoff policies are based on different metrics, giving an indication of whether or not to make handoff. In traditional handoffs, only RSSI (Received Signal Strength Indication), and channel availability are considered. An extension of handoff policies is based on:

- **QoS**, as different types of services require various combinations of reliability, latency, and data rate;
- **Monetary cost**, *i.e.* different networks may employ different billing strategies;
- **Network conditions**, such as traffic, available bandwidth, network latency, and congestion;
- **System performance**, such as channel propagation characteristics, path loss, inter-channel interference, Signal-to-Noise Ratio (SNR), and the Bit Error Rate (BER);
- **Mobile Terminal conditions**, as battery power and dynamic factors, such as velocity, moving pattern, moving histories, and location information. For example, if the battery level of a MT is low, a handoff can be performed in order to commute to a network that guarantees a lower power consumption. Also, if the user wants to guarantee a QoS level for its applications, he shall choose to switch to a particular network meeting these requirements.

### 2.2.1 IEEE 802.21 Media Independent Handover

IEEE 802.21 standard provides quick handovers of data sessions across heterogeneous networks with small switching delays and minimized latency [10]. The handover in heterogeneous networks could become more flexible and appropriate with this standard, employing innovative IEEE 802.21 mobile devices. In the specification, wired and wireless technologies are mentioned, such as 802.3, 802.11, 802.16, 3GPP, and 3GPP2. An overview of IEEE 802.21 standard helps to understand the scope of this protocol.

Seamless handover of data sessions is the main target, based on Media Independent Handover (MIH) functional model. The IEEE 802.21 specification classifies the function that enhances handovers across heterogeneous media. The MIH protocol entity is to every extent a new protocol layer that resides between the Network Layer (Layer 3) and the interface-specific lower layers (MAC and PHY in the case of IEEE interfaces, RRC and LAC in the case of 3GPP or 3GPP2 interfaces).

As discussed in [11], the main entities of IEEE 802.21 are:

1. a Media Independent Information Service (MIIS) that includes policies and directives from the Home Network (HN). The terminal refers to the HN policies, when performing handover decisions;
2. a Service Access Points (SAPs) to exchange service primitives between the MIH layer and its adjacent layers and functional planes;
3. a Decision Engine (DE) within the MIH instance, residing in the terminal, it identifies the best available access technology to support the current connectivity. The DE is

- a state machine that selects a preferred link based on available interfaces, policies, QoS and security parameter mapping;
4. a Transport Mechanism to facilitate the communication between the terminal MIH and the IS instance to access in the network.

The MIH function at the mobile terminal is continuously supplied with information regarding the network conditions, measured to perform the access in available heterogeneous networks. The MIH function receives the information through dedicated interfaces by exchanging messages with the IS entity positioned in the HN.

Generally, the MIHF defines three main services to perform handovers between heterogeneous networks, such as *i* Media Independent Event Service (MIES), *ii* Media Independent Command Service (MICS), and *iii* Media Independent Information Service (MIIS).

MIES provides event reporting, event filtering and event classification corresponding to dynamic changes in link characteristics, link quality and link status. It acts all the instances to make event detection and notify, maintaining the actual link connection of MT. Some of these events employed are “Link Up”, “Link Down”, “Link Detect”, “Link Parameter Reports”, and “Link Going Down”, [11]. MICS uses the MIHF primitives to send commands from higher layers to lower ones.

It determines the status of the connected links, performing mobile and connectivity decisions of the higher layers to the lower ones. Then, MIIS is a mechanism to discover available neighboring network information in order to facilitate handover process. It assures a set of information entities. The information entities are static and dynamic. In the first case, there are the names and services providers of the MT’s current network. The dynamic

information include link layer parameters such as channel information, MAC addresses, security information and other higher layer service information.

### 2.2.2 IEEE 802.21 Handover schemes

Now, we focus on some particular handover schemes developed in IEEE 802.21. The main characteristics are the MT, the Service Access Network (SAN) and the Candidate Network (CN), that represents the network destination of MT. Three schemes define the entities performing and interrupting the handover mechanism. They are defined as:

1. *Serving Network-Initiated and Candidate Network-Canceled Handover*: the SAN sends messages about information request to the IS to know if a handover mechanism can be initiated. The CN could not be an available resource, because of link quality level or network traffic status;
2. *Serving Network-Initiated and MT-Canceled Handover*: after sending information request messages to the IS, the MT could not be not available to perform handover, because of MT movement or user intervention or low battery that let the MT renouncing handover mechanism. In this case, the handover could be canceled directly by interaction between SAN and CN;
3. *MT-Initiated and MT-Canceled Handover*: in this case, the MT communicates only with the SAN, which sends messages of Resources-Request to the CN. The MT could be no more available to perform handover, (*e.g.* movement or time out or user intervention). So, it sends an Handover-Cancel message to SAN in order to stop the handover mechanism.

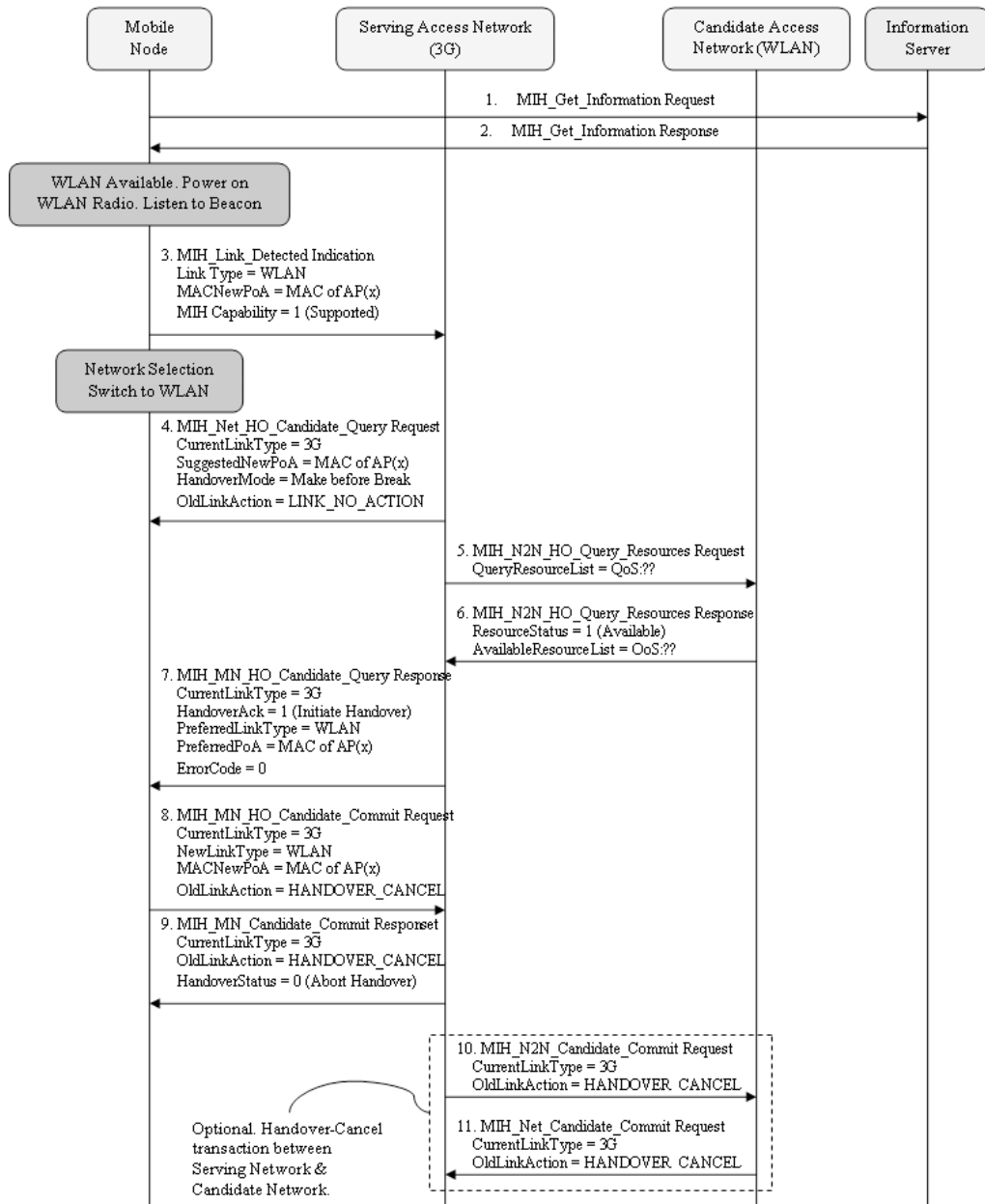

Figure 2.2: MT-Initiated and MT-Canceled Handover.

## 2.3 QoS-based Vertical Handover

As defined in IEEE 802.21 standard, QoS-based handover is a decision to perform a handover based on current and expected network conditions, according to the application QoS requirements [12]. Current network conditions are measured using network performance parameters from various layers, such as signal strength from layer 1, packet loss from layer 2, throughput and delay from layer 2+, etc.

According to the ITU-T Y.1540, the applications QoS requirements are defined by:

- Packet Transfer Delay (PTD), maximum end-to-end tolerated delay (in seconds);
- Packet Delay Variation (PDV), *i.e.* jitter: maximum packet jitter (in seconds);
- Packet Loss Ratio (PLR): maximum tolerated packet loss;
- Throughput: required data rate of successful packets (in bits/s).

Given the application QoS requirements, there is a main network entity, that implements a QoS-based handover: the QoS-based Decision Engine (QDE) [12]. It is an MIH user that considers application QoS requirements and network performance measurements provided by the MIH. The MIH function exchanges information between network entities and the QDE, including technology, protocol types and network measurements. The network performance conditions, such as instantaneous measurements for current conditions, are evaluated from past observations and previous connections, default estimates.

The QDE entity is located as a remote entity, as part of the MT, or the AP/BS. For our scope, we have placed it as a network entity, as illustrated in Figure 2.3.

No limitation occurs if QDE function is distributed over remote entities of each network. In this way, the MT receives Video Quality Metrics (VQMs) from QDEs of neighboring candidate networks.

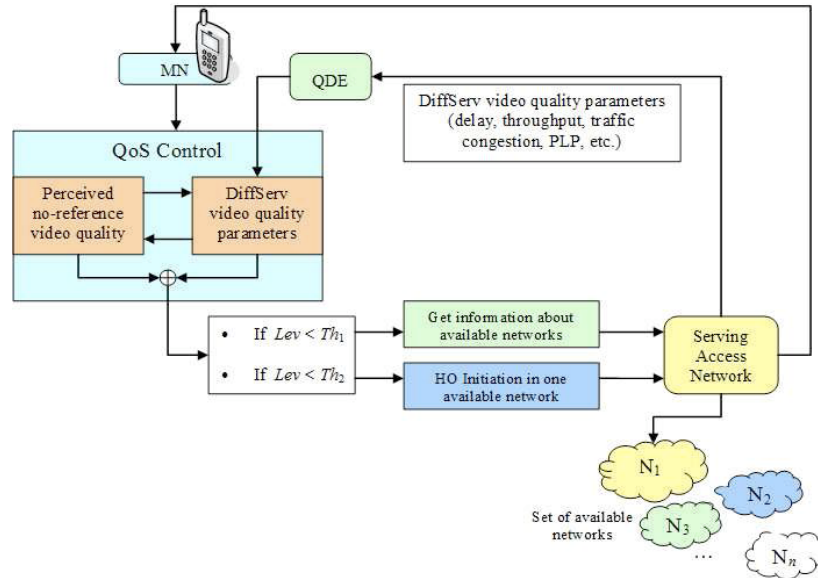

**Figure 2.3:** Proposed network architecture for QoS-based handoff.

### 2.3.1 No-Reference QoS metrics

During the last decade several techniques to assess the quality of multimedia services without performing a subjective test have been investigated, leading to objective quality metrics that approximate the MOS (Mean Opinion Score). These metrics are usually classified as full-reference, reduced reference and no-reference metrics. They differ in the amount of knowledge about the original multimedia flow used in the quality assessment.

Full reference methods evaluate the difference between the original signal and the received one and are, thus, rarely employed in real time assessment of video quality. On the

other hand, Reduced Reference (RR) metrics require a channel for sending a side information concerning a few characteristics of the original signal, while No-Reference (NR) metrics do not require any knowledge of the original. On the other hand, the perceived video quality highly depends on the end-user, according to his a priori knowledge of the topic, level of attention while looking at the video, and assigned task.

Here we employ an innovative NR Video Quality Metric (NR-VQM) that incorporates partial indicators proposed in [13, 14]. The quality metric mainly accounts for spatial and temporal resolution reduction, packet losses, latency, and delay jitter.

The NR-metric incorporates well-known indicators for the evaluation of the blocking, blurring and ringing introduced by current video coders as well as indicators of jerkiness and effects produced by packet losses. Jerkiness is evaluated by a neural network feed with estimated dynamics of objects composing the scene, trained by means of subjective tests.

Impact of packet losses on perceived quality is based on the analysis of the interframe correlation measured at the receiver side, [14]. Presence of error concealment algorithms employed by the receiver is also taken into account. The packet losses degradation assessment presents best performances for long sequences with slow motion.

Since the NR algorithm directly processes the rendered video, no information about the kind of errors, delays and latencies affecting the links is required. In addition, the NR techniques easily account for continuous increase of computing power of both mobile and wired terminals that allows wide spread of error concealment techniques to increase the perceived quality.

As detailed in [13], each rendered video frame is partitioned into square blocks. Then,



for each block the correlation coefficient time series are computed. The analysis of these time series allows to detect blocks affected by artefacts caused by the loss of those packets transporting the related bit stream, even when they have been partially restored by the error concealment procedure.

Then, a finer spatial analysis refines the degradation map, such as a static regions detection, vertical and horizontal edge consistency check and a repeated lines test. Visibility of residual artefacts can then be derived by the amount of blocking in small areas and edge continuity.

Subjective test evinced good agreement between NR metric and MOS, regardless of intrinsic video characteristic, and spatial-temporal resolution.

### **2.3.2 QoS-based Vertical Handoff in 802.21 Networks**

In our scheme the NR QoS is combined with a packet classification originally designed for DiffServ protocol, allowing different QoS grades to be mapped to different classes of aggregated traffic flows, [15]. It is an adaptive packet forwarding mechanism for a DiffServ network, mapping video packets onto different DiffServ levels based on Relative Priority Index (RPI), which represents the relative preference per each packet in terms of loss and delay. Effective QoS mapping is then performed by mapping video packets onto different DiffServ levels based on RPI. The packets are classified, conditioned, and remarked to certain network DS levels by considering the traffic profile based on the Service Level Agreement (SLA) and the current network status.

Let us now describe the proposed QoS-based handoff scheme, suited for real-time applications in IEEE 802.21 scenarios. The proposed architecture is characterized by a MT,

a QDE entity, a Serving Network, and a set of Target Networks (*i.e.*,  $N_1, N_2, \dots, N_n$ ).

Given a video application, QoS mapping is accomplished by mapping the relative prioritized packets to maximize end-to-end video quality. Each  $T$  seconds, the MT monitors the QoS-level (called as  $Lev$ ) for the videostreaming it is receiving from the current Serving Network. The QoS monitoring is performed on the basis of the NR-metrics, discussed previously.

NR method presents some basic indicators for temporal and spatial analysis: block distortion is evaluated by applying first a coarse temporal analysis for each frame, to extract blocks potentially affected by artifacts produced by lost packets. In our scope, NR technique addresses to audio and video flows evaluations to the receiver side and it could be also be tuned and optimized by means of a full-reference metric applied to some low rate probe signals.

Received videostreaming quality is monitored according to subjective evaluation. On the basis of user preferences, two appropriate QoS thresholds are defined, called as  $Th_1$ , and  $Th_2$ , with  $Th_1 > Th_2$ , respectively. Because of traffic congestions, errors introduced during transmission, lost packets or delay, QoS level can be lower than a first threshold, *i.e.*  $Lev < Th_1$ . In this first step, the MT only notices this decrement of  $Lev$  and waits to measure an other QoS-level. If  $Lev$  decreases again, handoff initiation can be required by MT, when  $Lev < Th_2$ .

The MT alerts to change the Serving Network and it sends this alarm message to a closer QDE. So, candidate networks scanning occurs, on the basis of VQM parameters, such as throughput, link packet error rate, Packet Loss Probability (PLP), supported number of

Class of Service (CoS), etc. All these parameters are sent in the information message “LINK QoS PARAMETER LIST”.

Based on the statistics computed on previous NR-QoS reports produced by the served MNs, when the QDE communicates with a MT, it can operate a conversion of VQM parameters for each network in NR-parameters. In this way, the MT evaluates which candidate network is appropriate for its video application.

For example, we suppose that a MT appears in the WLAN area and starts a video conversation with the Serving Network (SN). The QDE receives the alarm message of the MT and scans possible target networks, offering a better QoS level, *i.e.*  $Lev_1 > Lev$ , a set of target networks to hand over is selected, and the best network is chosen on the basis of MT preferences and handover policies. Only when SN declares a target network, the handoff can be initiated.

So, QDE performs a link selection and a handover is performed towards the IEEE 802.16 interface, as it supports better the applications QoS requirements. The evaluation of QoS- $Lev$  is performed from past observations and previous connections. Since the SN does not offer a constant QoS- $Lev$ , the quality performance assessment received by the MT is stored in a database (DB), for subsequent time series analysis. The quality is evaluated by a set of metrics, according to the MT profile. For example, a MT oriented to maintain a monetary cost level  $C_1$  and a quality level  $Lev_2$  will send his profile to the QDE. So, QDE will not choose an expensive network as possible target network.

Then, handover is performed according to the IEEE 802.21 messages in the scheme of Figure 2.2.

The proposed QoS-based handoff scheme is well suited for real-time applications in IEEE 802.21 scenarios. Figure 2.2 depicts the network architecture. A remote network entity, called QoS-based Decision Engine (QDE), [14], is in charge of the QoS-based handover. The MT exchanges information between network entities and the QDE, (*e.g.* technology, protocol types and network measurements). The network performance conditions, such as instantaneous measurements for current conditions, are evaluated from past observations and previous connections, default estimates. In this way, the MT receives VQMs from QDEs of neighbouring candidate networks, (*i.e.*,  $N_1, N_2, \dots, N_N$ ), as Figure 2.3 shows.

Finally, the NR QoS is combined with a packet classification originally designed for DiffServ (DS) protocol, allowing different QoS grades to be mapped to different classes of aggregated traffic flows. Effective QoS mapping is then performed by mapping video packets onto different DiffServ levels based on Relative Priority Index (RPI) which represents the relative preference per each packet in terms of loss and delay.

As an example, given a video application, QoS mapping is performed by mapping the relative prioritized packets to maximize end-to-end video quality. Each  $T$  seconds, the MT monitors the QoS-level ( $Lev$ ). To avoid an annoying degradation in quality and to prevent the “re-buffering” situation, two QoS thresholds are defined  $Th_1$  and  $Th_2$ , with  $Th_1 > Th_2$ . During a video communication, due to traffic congestions, transmission errors, packet loss, and delay, QoS level can decrease to the first threshold, ( $Lev < Th_1$ ). In this first phase, the MT notices this decrement of  $Lev$  and waits to measure another QoS level. If  $Lev$  decreases again, handoff initiation can be required by MT, when  $Lev < Th_2$ .

The MT alerts to change the Serving Network and sends this alarm message to a

closer QDE. So, a candidate networks scanning occurs on the basis of parameters, such as throughput, link packet error rate, Packet Loss Probability (PLP), supported number of Class of Service (CoS), etc.

All these parameters are sent in the information message “LINK QoS PARAMETER LIST”. Based on the statistics computed on previous NR-QoS reports produced by the served MTs, when the QDE communicates with a MT, it can operate a conversion of VQM parameters for each network in NR-parameters. In this way, the MT evaluates which candidate network is appropriate for its video application.

For example, supposing a MT appears in the WLAN area and starts a video conversation with the Serving Network (SN), the QDE receives the alarm message of the MT and scans possible target networks, offering a better QoS level, ( $Lev_1 > Lev$ ). A set of target networks to hand over is selected; the best network is chosen on the basis of MT preferences and handover policies. Only when SN declares a target network, the handoff can be initiated.

So, QDE performs a link selection and a handover is performed towards the IEEE 802.16 interface, as it supports better the application QoS requirements.

The evaluation of QoS- $Lev$  is performed from past observations and previous connections. Since the SN does not offer a constant QoS- $Lev$ , the quality performance assessment received by the MT is stored in a database, for subsequent time series analysis.

### 2.3.3 Analytical Model

We consider the overall handover delay  $L_{HO}$ , the handover frequency, and the available bandwidth. In the previous example, the handoff from UMTS to WLAN is always performed when WLAN is revealed, since WLAN has high priority vs. UMTS. Depending on

the network conditions, QoS-*Lev* from UMTS to WLAN could increase or be constant.

On the other way, switching from WLAN to UMTS (*i.e.* if WLAN is overflow), the QoS-*Lev* will decrease. In this case, handoff mechanism is performed only if it is necessary to maintain the connection on.

The average time delay considers the ratio between the average packet dimension and the transmission capacity of a network, as

$$E(t) = \frac{1}{\mu} = \frac{1}{C} \cdot \frac{\alpha\beta}{\beta-1} \cdot \frac{1-b^{(\beta-1)}}{1-b^\beta}. \quad (2.1)$$

The average time delay for a  $k$  network will be the sum of average time delay for the service and waiting one,

$$\tau_k = \frac{1}{\mu_k} \left[ \frac{1 + \rho_k (1 + Cb^2)}{2(1 - \rho_k)} \right], \quad (2.2)$$

that represents the Pollaczek-Kinchin formula.

The average time delay for a single packet sent from a  $N_1$  to  $N_2$  is weighted according to

$$T_{N_1 \rightarrow N_2} = \sum_{k=1}^N \tau_k \gamma_{N_1 \rightarrow N_2}^{(k)}, \quad (2.3)$$

where  $\gamma_{N_1 \rightarrow N_2}^{(k)}$  is the probability that packets are sent from  $N_1$  to  $N_2$ , on the link  $k$  with capacity  $C_k$  [bit/s].

The average packet rate represents how many packets are sent from  $N_1$  to  $N_2$ ,  $r_{N_1 \rightarrow N_2}$  [packets/s]. Considering all the available networks,  $(N_1, N_2, \dots, N_n)$ , the total average packet rate is

$$\Lambda_{Tot} = \sum_{i=1}^N \sum_{j=1}^N r_{N_j \rightarrow N_i}, \quad (2.4)$$

and the total mean time delay is

$$\Delta T_{Mean} = \frac{\sum_{i=1}^N \sum_{j=1}^N T_{N_j \rightarrow N_i} \cdot r_{N_j \rightarrow N_i}}{\sum_{i=1}^N \sum_{j=1}^N r_{N_j \rightarrow N_i}}. \quad (2.5)$$

When vertical handover occurs from  $N_i$  to  $N_j$ , we consider the probability  $\beta_{i,j}$  that an user moves from  $N_i$  to  $N_j$ . So, we can write the probability that an user moves from his own network as:

$$v_j = \sum_{i \neq j} \beta_{ij} = 1 - \beta_{ij}, \quad (2.6)$$

where  $v_j$  represents the probability a user do not move from his own network. In this way, we can find the average packet rate from  $N_i$  to  $N_j$  during handover, as

$$r_{N_j \rightarrow N_i} = \sum_m r_{N_j \rightarrow N_m} \beta_{jm} + \beta_{ij} \sum_h r_{N_j \rightarrow N_h}. \quad (2.7)$$

So, the total packet rate will be:

$$\begin{aligned} \Lambda_{Tot}^{HO} &= \sum_{i=1}^N \sum_{j=1}^N r_{N_j \rightarrow N_i} = \sum_i \sum_j \sum_m r_{N_j \rightarrow N_m} \beta_{jm} + \sum_i \sum_{j \neq i} \beta_{ij} \sum_h r_{N_j \rightarrow N_h} = \\ &= \Lambda_{Tot} + \sum_i \sum_{j \neq i} \beta_{ij} \sum_h r_{N_j \rightarrow N_h}. \end{aligned} \quad (2.8)$$

Now, by substitution of (2.6), and if  $\rho_j$  is the average rate of packets sent to  $N_j$ , the equation of  $\Lambda_{Tot}^{HO}$  becomes

$$\Lambda_{Tot}^{HO} = \Lambda_{Tot} + \sum_i v_j \rho_j. \quad (2.9)$$

If we consider an uniform handover probability, that means  $v_j = v$ , then  $\Lambda_{Tot}^{HO}$  is

$$\Lambda_{Tot}^{HO} = \Lambda_{Tot} (1 + v). \quad (2.10)$$

Finally, we define  $\rho^{HO}$  the handover throughput and  $\chi$  the rate between the average time delay in case and in absence of handover,

$$\begin{aligned}
\chi &= \frac{\tau^{HO}}{\tau} = \frac{\frac{1}{\mu_k} \left[ \frac{1+\rho^{HO}(1+Cb^2)}{2(1-\rho^{HO})} \right]}{\frac{1}{\mu_k} \left[ \frac{1+\rho(1+Cb^2)}{2(1-\rho)} \right]} = \frac{1+\rho^{HO}(1+Cb^2)}{1+\rho(1+Cb^2)} \cdot \frac{1-\rho}{1-\rho^{HO}} = \\
&= \frac{1+(1+Cb^2)\rho(1+v)}{1+(1+Cb^2)\rho} \cdot \frac{1-\rho}{1-\rho(1+v)}.
\end{aligned} \tag{2.11}$$

### 2.3.4 Vertical Handover Criteria

In the handover algorithm we considered several criteria to start vertical handoff from network  $N_1$  to  $N_j$ , where  $j \in \{1, 2, \dots, N\}$ . When a MT moves in his home network  $N_1$ , the QoS-*Lev* can decrease, due to many factors, such as the noise interference, channel capacity, delay or the low power signal strength.

QoS factor is monitored each  $T$  seconds by MT. When this parameters is lower than a threshold  $Th_2$ , vertical handover is performed. The choice of  $Th_2$  is an aim of the MT. Starting vertical handover is driven not only by QoS requirements, but also by some network parameters, as RSSI and distance criteria.

On the basis of [15], the channel propagation model for RSS is depicted by

$$RSS(d) = Pt - PL(d) + f(\mu, \sigma), \tag{2.12}$$

where  $Pt$  is the transmit power, and  $PL(d)$  is the path loss at distance  $d$  and  $f(\mu, \sigma)$  is a Gaussian random variable with mean  $\mu$  and deviation standard  $\sigma$  that models the shadow fading. The path loss at distance  $d$  is given by the following equation:

$$PL(d) = S + 10 \cdot n \cdot \log(d), \tag{2.13}$$

where  $S$  is the path loss constant depends on propagation environment and  $n$  is the path exponent with values in the range [2, 4].



When a mobile terminal is locating at position  $x$ , in the middle of two active networks,  $N_1$  and  $N_2$ , the respective received signal level averaged over  $N_1$  radio link and  $N_2$  radio link are  $\overline{r_{N_1}(x)}$ , and  $\overline{r_{N_2}(x)}$ . Their expressions are described by a lognormal distribution, as

$$\begin{cases} \overline{r_{N_1}(x)} \sim \mathcal{N} [\mu_{N_1}(x), \sigma_{N_1}^2] \\ \overline{r_{N_2}(x)} \sim \mathcal{N} [\mu_{N_2}(x), \sigma_{N_2}^2] \end{cases} \quad (2.14)$$

where  $\mu_{N_1}$  and  $\mu_{N_2}$  are the mean signal levels, and  $\sigma_{N_1}^2$  and  $\sigma_{N_2}^2$  are the shadowing standard deviations.

On the other hand, we consider the distance criterion which means handover starts when a MT has a distance  $d$  from the BS. Basically, the delay measurement of the signal delay between the MT and the BS is characterized by two terms, the real delay and the measurement noise  $t_{dn}$ . It is assumed to be a stationary zero-mean random process with normal distribution, as

$$t_{dn} \sim \mathcal{N} [0, \sigma_{t_{dn}}^2], \quad (2.15)$$

where  $\sigma_{t_{dn}}^2$  is the standard deviation. So, the measured distance  $d_{N_i}$  from MT to the reference BS of network  $N_i$  is also a stationary random process with mean  $d$  and variance  $c^2\sigma_{t_{dn}}^2$ , as  $c$  the speed of light. Finally, the distance distribution is also normal,

$$d_{N_i} \sim \mathcal{N} [d, c^2\sigma_{t_{dn}}^2]. \quad (2.16)$$

### 2.3.5 Vertical Handover Algorithm

According to each parameter we consider to make handover, we have to fix different thresholds, called as  $R$ ,  $D$  and  $Q$  for RSS, distance and quality criterions, respectively. Each

threshold is typical for a single access network. As an example we define  $R_W$  and  $R_U$  the RSS thresholds for WLAN and UMTS, respectively.

Now, we suppose a MT moves into the home network  $N_1$ . Each  $T$  seconds, the MT makes the RSS measurement and distance evaluation from the position  $x$  to the nearest BS in  $N_1$ . Then, evaluation of QoS-*Lev* is performed.

So, we can list the main steps of our vertical handover algorithm, before performing handover:

1. *Measurement phase*: each  $T$  seconds, the MT makes all the measurements for RSS, distance and QoS;
2. *QoS prioritization*: the probability to perform an handover is determined by a mix of measurements, such as RSS, distance and QoS-*Lev*. As this vertical handover algorithm is oriented to QoS, QoS-*Lev* is the main factor;
3. *Initialization*: if QoS-*Lev* is lower than a  $Th_1$  threshold, the MT sends a message to a closer QDE for candidate available networks;
4. *Candidate networks scanning*: on the basis of VQM parameters, such as throughput, link packet error rate, PLP, and CoS, a list of candidate networks is created. The "LINK QoS PARAMETER LIST" message collects all the VQM parameters;
5. *VQM conversion*: each MT has previous NR-QoS reports. When the QDE communicates with a MT, it can operate a conversion of VQM parameters for each network in NR-parameters. In this way, the MT evaluates itself which candidate network is appropriate for its video application.

After all these steps, if *QoS-Lev* decreases lower than  $Th_2$ , the MT initiates handover from its home network to a new serving network.

### 2.3.6 Vertical Handover Probability

We suppose to perform handover from UMTS to WLAN. The handover decision occur when the RSS measurement on WLAN is upper than a  $R_W$ , the distance from MT to WLAN BS is lower than  $D_W$  and then, the *QoS-Lev* in WLAN is upper than  $Q_W$ .

It is expressed as:

$$\left[ \overline{r_W(x)} \geq R_W \right] \text{ and } [d_W \leq D_W] \text{ and } [q_W \geq Q_W]. \quad (2.17)$$

In this scenario, a MT prefers to switch from UMTS to Wi-Fi, because of chipper Wi-Fi monetary cost than UMTS. So, in (2.17) we do not consider the RSS, the distance and the QoS criteria on UMTS.

On the other hand, handover from WLAN to UMTS is depicted by

$$\left[ \overline{r_W(x)} \leq R_W \right] \text{ and } \left[ \overline{r_U(x)} \geq R_U \right] [d_U \leq D_U] \text{ and } [q_U \geq Q_U] \quad (2.18)$$

where  $\overline{r_W(x)}$  is lower than a  $R_W$ , while  $\overline{r_U(x)}$  is upper than  $R_U$ . It means that handover from WLAN to UMTS is chosen when it is really necessary.

Now, according to (2.17) and (2.18), the probability to initiate the handover from UMTS/Wi-Fi to Wi-Fi/UMTS on position  $x$ , is respectively:

$$P_{U \rightarrow W}(x) = P \left\{ \left[ \overline{r_W(x)} \geq R_W \right] \right\} \cdot P \{ [d_W \leq D_W] \} \cdot P \{ [q_W \geq Th_2] \}, \quad (2.19)$$

and

$$P_{W \rightarrow U}(x) = P \left\{ \left[ \overline{r_W}(x) \leq R_W \right] \right\} \cdot P \left\{ \left[ \overline{r_U}(x) \geq R_U \right] \right\} \cdot P \{ [d_U \leq D_U] \} \cdot P \{ [q_U \geq Th_2] \}. \quad (2.20)$$

We can make some considerations about (2.19) and (2.20). Handover probabilities are calculated under three conditions, that are the RSS, the distance and the QoS criteria. As QoS is the main parameter to drive handover, if in (2.19)

$$P \{ [q_W \geq Th_2] \} \cong 1, \quad (2.21)$$

and in (2.20)

$$P \{ [q_U \geq Th_2] \} \cong 1, \quad (2.22)$$

handover can be initiated only by QoS parameters.

Figure 2.4 shows the handover mechanism driven by QoS, for different networks, such as UMTS, Wi-Fi and WiMAX. A MT transmits on UMTS link. When the QoS-*Lev* is lower than  $Th_2$ , and a Wi-Fi link is available to accept a new user, the MT makes handover from UMTS to Wi-Fi. In this way, the MT gains quality for its service.

Then, QoS-*Lev* in Wi-Fi link is lower than  $Th_2$ . This threshold is always the same for a MT, it is only dependent by service of MT. So, a handover from Wi-Fi to WiMax occurs, when WiMax network is able to accept a new user.

In Figure 2.4, we suppose that if the QoS-*Lev* decreases again and there are no more available networks, the MT can decide:

1. to switch to previous networks, if they are yet available,
2. to change  $Th_2$  value, *i.e.*  $Th_3 < Th_2$ , and start again the overall handover mechanism,

3. to maintain QoS-*Lev*.

We observe that  $Th_1$  corresponds to a quality perceivable loss, and so it is upper to a just noticeable distortion. We considered that this decreasing quality level is not variable, but it is a constraint for a  $T_q$  time interval. Then, the second threshold  $Th_2$  is set just to have a seamless service connection.

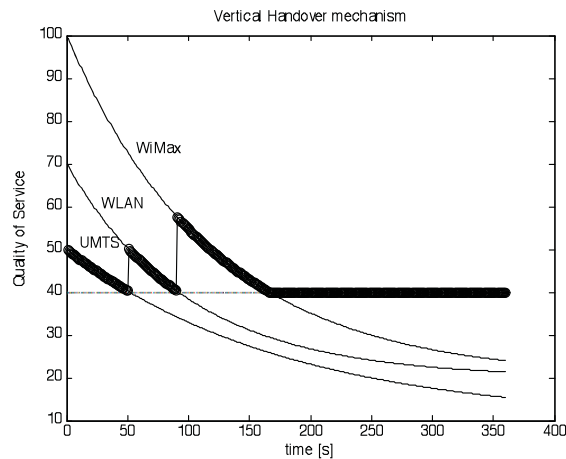

**Figure 2.4:** Theoretical behaviour of QoS-based VHO algorithm.

## 2.4 Goodput-based Vertical Handover

A power-based metric represents the traditional process for handover mechanism. Novel techniques describe reactive algorithms for management of mobile controlled vertical handover (VHO).

In this Section, we illustrate a vertical handover algorithm for dual-mode terminals provided with UMTS and IEEE 802.11 Network Interface Cards (NICs). The proposed technique aims at providing service continuity and maximize throughput while limiting

*ping-pong* effect. The main aspect is the power-based metric, associated with a channel estimation method. This VHO algorithm has been presented in [1].

Experimental results have been collected in order to provide an assessment of its performance. Namely, in the presented statistics is discussed how channel bandwidth estimation and limitation of handover frequency can affect maximization of throughput.

### 2.4.1 Channel Estimation

The proposed VHO algorithm is focused on the comparison of the instantaneous goodput reachable from an MT with a UMTS or a Wi-Fi interface, while moving in an area with simultaneous UMTS/Wi-Fi coverage. The assessment of the goodput experienced through two interfaces can be done with various channel estimation methods, such as a (i) Weighted Moving Average (WMA) of the last  $K$  samples of the amount of data  $g_i$  received simultaneously from the two interfaces, and an (ii) Exponential Smoothing Average (ESA) technique, respectively.

In the first case, the estimate of the channel goodput at time  $N$  is

$$GP_N = \sum_{i=N}^{N+K} a_i \cdot g_i, \quad N \geq K \quad (2.23)$$

In this case, the weights  $a_i$  assigned to  $g_i$  are the same and are equal to  $1/N$ . As an

alternative, for the ESA technique the estimate of the channel goodput is as follows,

$$\left\{ \begin{array}{l} GP_1 = g_1, \\ GP_2 = w_1 \cdot g_2 + (1 - w_1) \cdot GP_1, \\ GP_N = w_1 \cdot g_N + w_2 \cdot GP_{N-1} + w_3 \cdot GP_{N-2}, \quad N > 2 \\ 0 < w_1, w_2, w_3 < 1, \\ \sum_{i=1}^N w_i = 1, \end{array} \right. \quad (2.24)$$

where the goodput estimate  $GP_i$  is a weighted sum of the last collected goodput sample  $g_i$  and the previous two estimates  $GP_{i-1}$ ,  $GP_{i-2}$ .

It can be shown that the adjustment of the data samples  $g_i$  to the goodput estimate  $GP_i$  decreases exponentially vs. time. The speed at which the older samples are smoothed is higher for increasing values of  $w_1$  and decreasing values of  $w_2$ , and  $w_3$ .

### 2.4.2 VHO algorithm

Based on previous estimation techniques, the proposed VHO algorithm works according to the following flowchart (see Figure 2.5).

The VHO algorithm starts with the selection of the Wi-Fi network if the measured power from the Wi-Fi NIC, *i.e.*  $P_W$ , is bigger than the mobile node Wi-Fi receiver sensitivity, *i.e.*  $P_{W-\min}$ , which denotes connectivity available in the Wi-Fi network. Otherwise, the UMTS NIC selection is attempted and the UMTS receiver sensitivity, *i.e.*  $P_{U-\min}$ , is used to detect UMTS network availability.

When connectivity is not available from any of the network, the algorithm perform attempts to select a network at regular interval of times. Namely, every time an attempt to

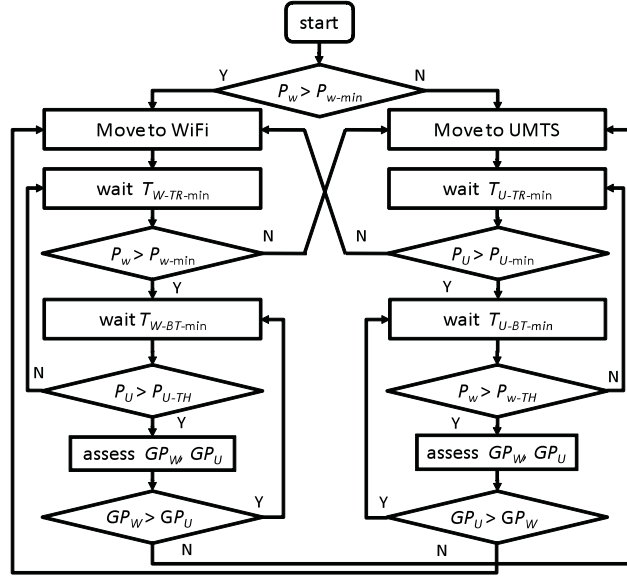

Figure 2.5: Flowchart of the goodput-based VHO algorithm.

move to a new network fails a movement to the other network is attempted after a suitable *waiting time*, which is set different for the UMTS and Wi-Fi network, (*i.e.*  $T_{U-TR-min}$ , and  $T_{W-TR-min}$  for UMTS and Wi-Fi, respectively).

The waiting time is introduced to limit the ping-pong effect. Namely, the greater is the *waiting time* the smaller will be the number of vertical handovers. When connectivity is available only through one NIC, this is selected automatically. Finally, whenever Wi-Fi and UMTS connectivity are both available an assessment of the best network interface is performed. The proposed algorithm is based on several time parameters, working as hysteresis factor to reduce VHO frequency. *Ping-pong* effect depends not only on limited hotspots coverage, but also the time parameter settings in VHO algorithm. So, the frequency of search for a new interface is still limited by the parameter  $T_{W-TR-min}$  and  $T_{U-TR-min}$  in



order to limit the ping-pong effect. Connection is then moved from the current interface to the new one, only if two following conditions are satisfied:

1. the estimated goodput of the new interface is greater than that currently selected;
2. the measured power on the new interface is greater than a minimum value (*i.e.*  $P_{W-TH}$  for UMTS or  $P_{U-TH}$  for Wi-Fi) which is bigger than its sensitivity, (*i.e.*  $P_{W-min}$  or  $P_{U-min}$ , for Wi-Fi and UMTS, respectively).

The algorithm then adopts two measures for limiting the ping-pong effect, *i.e.* using both the VHO *waiting times*,  $T_{W-R-min}$  and  $T_{U-TR-min}$ , and the power thresholds,  $P_{W-TH}$  and  $P_{U-TH}$ , for Wi-Fi and UMTS, respectively. Goodput estimation can be performed in various ways. One possibility is to transmit a sequence of probing packets at the maximum allocated capacity from both Wi-Fi and UMTS interfaces. In order to save battery power by the two parameters,  $T_{W-BT-min}$  and  $T_{U-BT-min}$ , which fix the minimum interval of time between two channel estimations when connection is on the Wi-Fi or UMTS network respectively.  $T_{W-BT-min}$  and  $T_{U-BT-min}$  can be fixed empirically to find a good compromise between the goodness of channel estimation and the save of battery.

### 2.4.3 Simulation Results

To validate the VHO performance and tune the algorithm parameters, we realized a Matlab simulation environment, consisting of 3 UMTS cells, and 30 Wi-Fi hot-spots.

In the simulated environment an MT moves randomly at 0.5 m/s speed in a region of 2 km  $\times$  2 km modeled with a map of 400  $\times$  400 zones of 5 m  $\times$  5 m. In Figure 2.6 is depicted the heterogenous map by the data rate in each wireless cell. Moreover, a random

path of an MT is also represented.

The map shows the zones where the 30 Wi-Fi hot spots and 3 UMTS cells are located. The Wi-Fi and UMTS cell sizes are set on 120 and 600 m, respectively assuming an outdoor scenario.

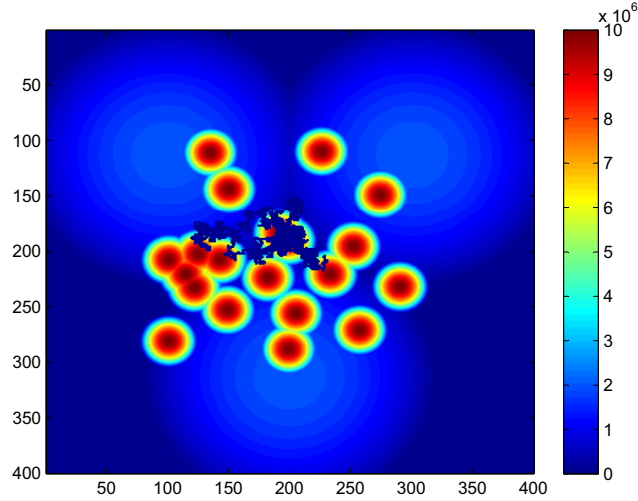

**Figure 2.6:** Heterogeneous network environment, composed by a set of UMTS BSs, and Wi-Fi Access Points. The MT is moving at low speed (*i.e.* 0.5 m/s).

In the simulations, we set the following parameters:

- the transmitted power in the middle of UMTS cell is about 43 dBm, according to UMTS cell requirements;
- the UMTS/Wi-Fi receiver sensitivities are set at  $-100$  dBm, according to UMTS/Wi-Fi cell requirements, respectively;
- the  $P_{U-TH}$  and  $P_{W-TH}$  parameters are set at  $-100$  dBm, equal to the UMTS/Wi-Fi sensitivity,  $P_{U/W-\min}$ , respectively;

- to save battery life,  $T_{W-BT-\min}$  parameter is set at 10 s.

Then, for the channel model, we considered a typical AWG (Additive White Gaussian) one, and referred to the Okomura-Hata model for the signal power attenuation. We collected statistics on goodput and number of vertical handovers on different Wi-Fi and UMTS maps generated randomly. We simulated an MT moving for 5000 steps at a speed of 0.5 m/s, (*e.g.* a man walking).

In order to obtain a comprehensive analysis of the algorithm performance, we analyzed the mean behavior of the system and performed an optimization of the parameters and of the goodput estimation function, which impacts the handover frequency and the available bandwidth. Goodput estimation was performed using the presented ESA approach by choosing different values for the weights, (*i.e.*  $w_1 = 0.1$ ,  $w_2 = 0.4$ , and  $w_3 = 0.5$ ), and an MA with  $N = 5$  samples.

Figure 2.7 shows the number of vertical handover performed by the algorithm vs. the *waiting time*. Two curves obtained with the ESA and MA approaches are compared. With the ESA approach the number of handovers are generally greater than those with the MA approach. We do not consider the number of VHOs as a performance parameter to be minimized but rather we used it in order to assure a limitation of the VHOs, being the *waiting time*  $T_{W/U-TR}$  a precise constraint to satisfy.

In Figure 2.8, the total amount of received bits is a function of the *waiting time* parameter, and performance of the ESA approach appears better than that of the MA one. Again, we chose the same values for  $T_{W-TR}$  and  $T_{U-TR}$ .

On the whole, we can conclude that the greater number of handover experienced with

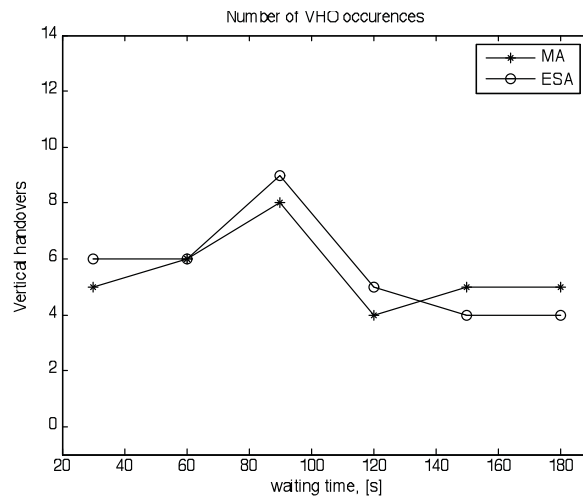

Figure 2.7: Number of VHOs vs. *waiting time*, [1].

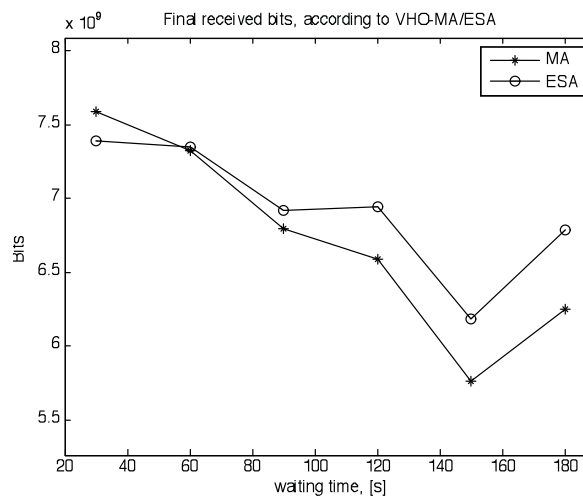
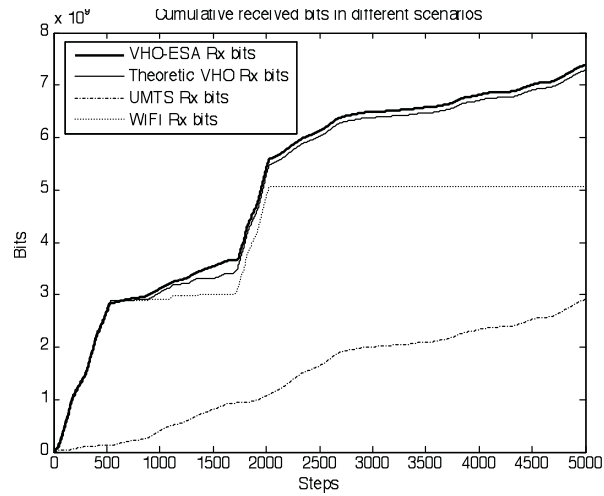

Figure 2.8: Total received bits vs. *waiting time*, [1].



**Figure 2.9:** Performance of the proposed VHO algorithm, [1].

the ESA approach for channel estimation brought about better performances.

Then, in Figure 2.9 is depicted the number of received bit over the MT steps in 4 cases, such as:

- the MT is provided only with a Wi-Fi NIC, (see curve Wi-Fi Rx bits);
- the MT is provided only with a UMTS NIC, (see curve UMTS Rx bits);
- the MT is provided with a Wi-Fi and UMTS NIC and is able to instantaneously estimate the best channel and select the network with the current best goodput, (see curve Theoretic VHO Rx bits);
- the MT is provided with a Wi-Fi and UMTS NIC and performs the proposed algorithm, where limitations to the VHO frequencies are posed by the parameter  $T_{W-TR-\min}$  and  $T_{U-TR-\min}$  set both to 30 seconds, (see curve VHO-ESA Rx bits).

As expected, the curve relevant to the presented algorithm denotes better performance of both the cases of UMTS and Wi-Fi single-mode mobile terminals.

The novel VHO algorithm exhibits performance which are also slightly better than the case when no measure for the *ping-pong* effect is applied. This shows that waiting a few seconds prior performing a handover can be useful not only to reduce the *ping-pong* effect, but also to avoid moving to a network where performance can degrade rapidly. This is the typical case when an MT wanders at the boundary of a Wi-Fi cell, and moves frequently out of range. So, the best choice of time parameters is for low  $T_{W/U-TR-\min}$  values, not exceeding the number of VHO occurrences, and VHO-ESA approach for high  $w_3$  values, (*i.e.*  $w_3 = 0.5$ ).

## 2.5 Location-based Vertical Handover

Many handover algorithms incorporate a hysteresis cycle within handover decisions so as to prevent a mobile node moving along the boundary of a wireless cell to trigger handover attempts continuously. This phenomenon is well known in the literature under the name of *ping-pong* effect and hysteresis is largely adopted in practical implementations.

Here we analyze a location-based vertical handover approach which aims at the twofold goal of maximizing the goodput, and limiting the ping-pong effect. Experimental results obtained through computer simulation provide an assessment of the potentialities of using location information for VHO decisions, especially in the initiation process.

More specifically we consider a vertical handover algorithm for dual-mode mobile terminals provided with a UMTS and a Wi-Fi network interfaces. This vertical handover

approach is mobile-driven, soft, based on mobile location information and measured goodput which is performed during handover attempts. In order to limit the so called pingpong effect a hysteresis cycle is introduced in handover decisions.

Namely, mobile terminal's location information is used to initiate handovers, that is, when the distance of the MT from the centre of the cell of the new network towards which a handover is attempted (hereafter referred to as new network) possesses an estimated goodput, *i.e.*  $GP^{NEW}$ , significantly greater than the goodput of the current network, *i.e.*  $GP^{CURR}$ . Following a handover initiation a channel goodput estimation procedure is performed for both the current network, which terminates with an effective handover execution if the goodput of the new network is effectively greater than the goodput of the current network.

In our handover approach we are interested in defining a simple mechanism (*handover initiation*) to initiate handovers to estimate  $GP$ , followed by a more accurate estimate (*handover assesment*) which actually enables or prevent handover execution.

### 2.5.1 Handover Initiation

The goodput experienced by a MT in a wireless cell depends on the bandwidth allocated to the mobile for the requested services and the channel quality. When unelastic traffic, *e.g.* real-time flows over UDP, is conveyed the goodput is given by:

$$GP = BW \cdot (1 - P_{out}), \quad (2.25)$$

where  $BW$  is the bandwidth allocated to the mobile and  $P_{out}$  is the service outage probability. When elastic traffic is conveyed (typically when TCP is used), throughput tends to

decrease with increasing values of  $P_{out}$ .

$BW$  is a function of the nominal capacity, of the MAC algorithm which is used in a specific technology and sometimes of the experienced  $P_{out}$ . The maximum theoretical  $BW_{Wi-Fi}$  is equal to 23 Mbit/s (out of a nominal capacity of 54 Mbit/s) in a IEEE 802.11a link [16], though it tends to decrease rapidly with the number of users because of the contention-based MAC. The maximum  $BW_{UMTS}$  is equal to 14.4 Mbit/s for a HSDPA network, which however, decreases rapidly with  $P_{out}$ . In handover initiation we are considering the maximum value of  $BW$ , *i.e.*  $BW_{max}$  which is obtained in the case of a single MT in the cell and with a null  $P_{out}$ , as the actual goodput will be measured directly in the handover assessment phase.

$P_{out}$  is a function of various parameters. In the UMTS network it can be calculated theoretically [17], using the following formula:

$$P_{out}^{UMTS} = \Pr \left\{ \frac{E_{b,Tx}^{UMTS}}{I_0 + (\gamma\sigma_N^2)_{UMTS}} \cdot A_d^{-1}(r_{UMTS}) \leq \mu_{UMTS} \right\}, \quad (2.26)$$

where  $E_{b,Tx}^{UMTS}$  is the bit energy in the received signal,  $\mu$  and  $\gamma$  are parameters dependent on the signal and interference statistics,  $\sigma_N^2$  is the receiver noise power,  $A_d(r_{UMTS})$  is the signal attenuation factor dependent on the MT's distance  $r^{UMTS}$  from the centre of the cell, and  $I_0$  is the inter and intracell interference power.

$I_0$  can be rewritten in terms of the number  $N_{interf}$  of effective interfering users as follows:

$$I_0 = \frac{N_{interf}}{G_{spread}} \cdot E_b, \quad (2.27)$$

where  $G_{spread}$  is the WCDMA spreading factor.



The service outage probability for a Wi-Fi network  $P_{out}^{Wi-Fi}$  can be calculated theoretically in a similar fashion using the following formula:

$$P_{out}^{Wi-Fi} = \Pr \left\{ \frac{E_{b,Tx}^{Wi-Fi}}{(\gamma\sigma_N^2)_{Wi-Fi}} \cdot A_d^{-1}(r_{Wi-Fi}) \leq \mu_{Wi-Fi} \right\}. \quad (2.28)$$

We define as the radius of a wireless cell  $R_{cell}$  the distance from the cell center beyond which the signal to noise ratio or the signal to interference ratio falls below the minimum acceptable value  $\mu$ .  $R_{cell}$  can be obtained resolving the above equations or empirically, through measurement on the network. As an alternative, typical value for well-known technologies can be used, *e.g.*  $R_{cell}^{Wi-Fi} \cong 120$  m for IEEE 802.11 a outdoor, and  $100 \text{ m} < R_{cell}^{UMTS} < 1$  km for an UMTS micro-cell [18].

The path loss  $\overline{A_d}(r)$  is approximately proportional to  $r^\gamma$ , and the received power  $SNR(r)$  can be written as, [18]:

$$SNR(r) = \mu \left[ \left( \frac{R_{cell}}{r} \right)^\gamma + \delta A_d \right]. \quad (2.29)$$

Maximum  $GP$  in a Wi-Fi and UMTS cell can be calculated with the following approximated formulas,

$$\begin{cases} GP_{\max}^{UMTS} = BW_{\max}^{UMTS} \cdot \Pr \left\{ \left( \frac{R_{cell}^{UMTS}}{r_{UMTS}} \right)^\gamma + \delta A_d < 1 \right\} \\ GP_{\max}^{Wi-Fi} = BW_{\max}^{Wi-Fi} \cdot \Pr \left\{ \left( \frac{R_{cell}^{Wi-Fi}}{r_{Wi-Fi}} \right)^\gamma + \delta A_d < 1 \right\} \end{cases} \quad (2.30)$$

which will be regarded as zero out of cells.

Handover initiation will be performed when the estimated goodput of the new network is greater than the current one. Namely, in the case of vertical handover from Wi-Fi to UMTS, the following equations apply respectively:

$$GP_{\max}^{UMTS} < GP_{\max}^{Wi-Fi}. \quad (2.31)$$

It is worth noticing that when handover executions are taken too frequently, the quality as perceived by the end user can degrade significantly in addition to wasting battery charge. This phenomenon is well-known and called in the literature ping-pong effect. It can be useful to limit handover frequency by imposing a minimum interval of time between two consecutive handovers, which can be set different when connected to Wi-Fi or UMTS. We refer hereafter to the minimum interval between consecutive handovers with the parameter  $T_{wait_{UMTS/Wi-Fi}}$ .

### 2.5.2 Handover Assessment

When a handover procedure is initiated a soft transition from the current network to the new network is attempted. In this phase channel goodput through the two networks is estimated for a short transient of time during which the sessions currently received are bycasted to both the current and new network interface. During the transient, the goodput experienced from the two interfaces is measured. The assessment of the goodput experienced through two interfaces can be done with various channel estimation methods, *e.g.* using the Weighted Moving Average, which is defined as follows.

Let us consider a convenient interval of time, divided into  $K$  subintervals of duration  $\Delta t$ , during which the UMTS and Wi-Fi channels are estimated. Let  $i$  be the discrete time variable.

If channel estimation begins at time  $N$ ,  $i$  will then range in  $[N, N + K]$ . Let  $g_i$  be the received amount of data in the  $i$ -th subinterval over  $\Delta t$ , the WMA-based goodput

estimation at time  $N$  is given by:

$$GP_N = \sum_{i=N}^{N+K} a_i \cdot g_i, \quad N \geq K. \quad (2.32)$$

Following the handover assessment, the goodput measured for UMTS and Wi-Fi are compared and if an improvement of the goodput is expected in case of change of network the handover is executed, that is, if  $GP_N^{NEW}$  is greater than  $GP_N^{CURR}$  is performed.

### 2.5.3 Handover Algorithm

The steps of the proposed LB-VHO algorithm is depicted in Figure 2.10. It starts selecting by default the Wi-Fi network if the measured power from the Wi-Fi NIC, *i.e.*  $P^{Wi-Fi}$ , is bigger than the MT's Wi-Fi receiver sensitivity, *i.e.*  $P_{min}^{Wi-Fi}$ , generally set to  $-100$  dBm. Otherwise, the MT detects UMTS network availability.

If either Wi-Fi or UMTS connectivity is not available, the algorithm performs attempts to select a network at regular interval of times till a network is available and is selected. Different  $T_{wait}^{UMTS/Wi-Fi}$  values were chosen in the simulation setup, as this parameter affects the algorithm's performance, in terms of *ping-pong* effect limitation. In our simulations, we considered the following  $T_{wait}^{UMTS/Wi-Fi}$  values:

$$T_{wait}^{UMTS/Wi-Fi} = i \cdot 10, \quad i = 0, 1, 2, \dots, 6. \quad (2.33)$$

respectively, corresponding to no wait, 10 s, 20 s, and so on until 60 s. So, if the MT moves at 1 m/s, a 10 s *waiting time* results to 10 m walked.

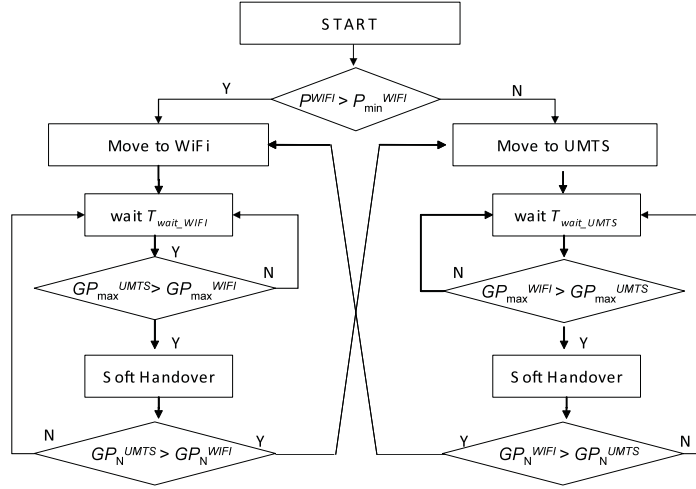

**Figure 2.10:** Flowchart for the proposed Location based Vertical Handover.

#### 2.5.4 Simulation Results

Some simulation results are now presented to assess performance of the Location-based Vertical Handover (LB-VHO) algorithm. We have compared performance of the LB-VHO with a corresponding handover with a traditional Power-based vertical handover, (PB-VHO), [1] *i.e.* using power measurements in order to initiate VHOs instead of mobile location information.

We modeled movements of a MT over a grid of  $400 \times 400$  square zones, each with an edge of 5 m, where 3 UMTS cells, and 20 IEEE 802.11b WIFI cells are located. The MT moves with a low speed (*i.e.* 1 m/s), corresponding to a man walking speed, inside an heterogeneous map with UMTS and Wi-Fi coverage for 12500 seconds. The MT's path is generated randomly. We have collected statistics on the total amount of bits received by the MT, for 4 cases, *i.e.* a dual-mode Wi-Fi/UMTS terminal using LB-VHO algorithm, a

dualmode Wi-Fi/UMTS terminal using PB-VHO algorithm, a Wi-Fi single-mode terminal, and a UMTS single-mode terminal used. Each scenario differs from the other in terms of the UMTS/Wi-Fi cell location and the path of the MT on the grid. Table 2.0(a), shows the statistics collected for  $S = 20$  randomly generated scenarios.

Performance are assessed against:

- the Cumulative Received Bits (CRB) from the beginning to the end of the simulations with the LB and PB strategies;
- the number of vertical handovers performed by the user moving in the grid.

Table 2.0(a) shows statistics on the CRB collected in the simulations. For each approach LB and PB, and for several values of *waiting time*, three parameters are reported related to the CRB, such as *i.e.* the mean value (in Gigabit), the standard deviation (in Gigabit) and the dispersion index, defined as the ratio of the standard deviation over the mean value. The three value for LB and PB are reported for a *waiting time*  $T_{wait}$  of 0 s and 60 s.

The LB approach bring about reduction of CRB between 6.5% for a null *waiting time* and 20% for *waiting time* equal to 60 s, which suggests that the *waiting time* constraint should not be applied to LB approach to reduce number of vertical handovers in order to have a limited reduction of CRB.

Table 2.0(b) shows results of the number of VHO experienced with the LB and PB approach, still in terms of the mean value, standard deviation and dispersion index for various *waiting time* values. It can be noticed that the number of vertical handover with LB is on average significantly smaller, *i.e.* ranging in [9.65, 3.70] than that experienced with PB approach, *i.e.* ranging in [9.15, 329.85]. This demonstrate that the PB approach really

(a) Statistics of the CRBs for PB and LB approach

	Waiting Time	Mean	Stand. Dev.	Disp. Index
	[s]	[Gbit]	[Gbit]	[Gbit]
PB	0	6.23	2.30	36.90 %
	60	5.76	2.14	37.13 %
	Waiting Time	Mean	Stand. Dev.	Disp. Index
	[s]	[Gbit]	[Gbit]	[Gbit]
LB	0	5.82	2.38	40.91 %
	60	4.59	2.34	50.88%

(b) Statistics for Number of VHOs for PB and LB approach

	Waiting Time	Mean	Stand. Dev.	Disp. Index
	[s]	[Gbit]	[Gbit]	[Gbit]
PB	0	329.85	794.50	240.87 %
	10	30.20	46.36	153.51 %
	20	19.90	22.54	113.26 %
	30	14.10	16.29	115.53 %
	40	11.80	12.49	105.85 %
	50	9.80	10.58	107.99 %
	60	9.15	7.57	82.75 %
	Waiting Time	Mean	Stand. Dev.	Disp. Index
	[s]	[Gbit]	[Gbit]	[Gbit]
LB	0	9.65	2.00	20.73%
	10	7.25	1.15	15.93%
	20	5.85	2.31	39.48%
	30	5.15	1.15	22.42%
	40	4.35	1.15	26.54%
	50	4.20	2.00	47.62%
	60	3.70	1.15	31.21%

**Table 2.1:** Statistic results for PB and LB VHO algorithms.

requires a constraint on handover frequency limitations, while we have already shown that this measure is counterproductive with LB.

In Figure 2.11, the mean values of vertical handovers with LB and PB vs. the *waiting time* constraint are depicted. This shows even more clearly, how the LB approach, providing a more accurate assessment for handover initiation, is able selfcontrol handover initiations and prevent handover execution which can bring about little performance gain. PB approach is unstable even for high values of *waiting time*, as it can be noticed from the fact that the PB curve is not monotone.

In Figure 2.12 and 2.13 are reported the dynamics of the CRB over the mobile terminal steps during the simulation (a step is performed every 5 seconds) for a null waiting time, and a waiting time of 60 s. Curves in Figure 2.12 do not follow the same profile, unlike in Figure 2.13. This shows the instability of PB approach when no *waiting time* constraint is applied.

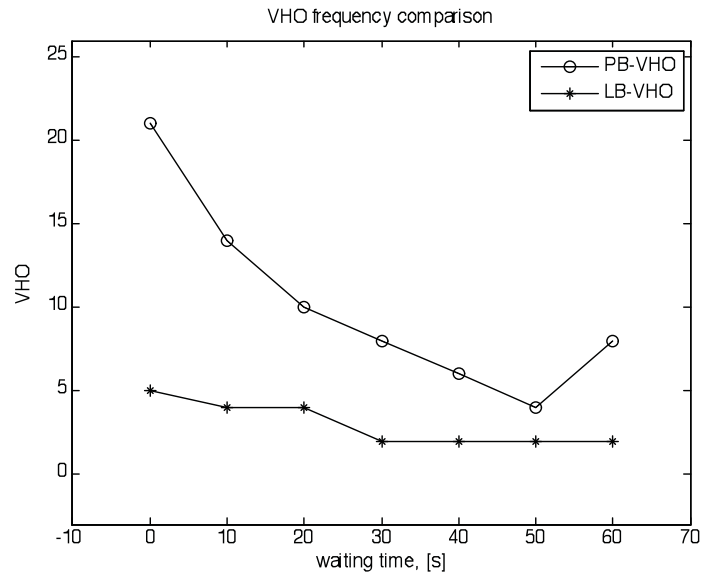

Figure 2.11: Number of vertical handovers in PB-VHO and LB-VHO cases.

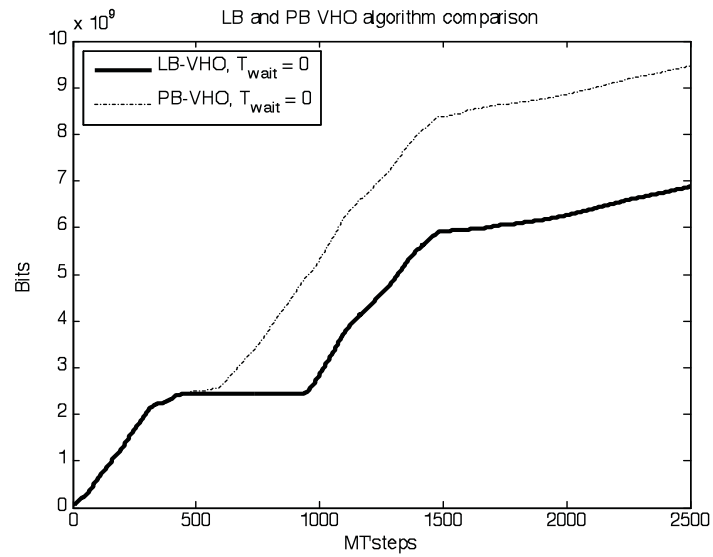
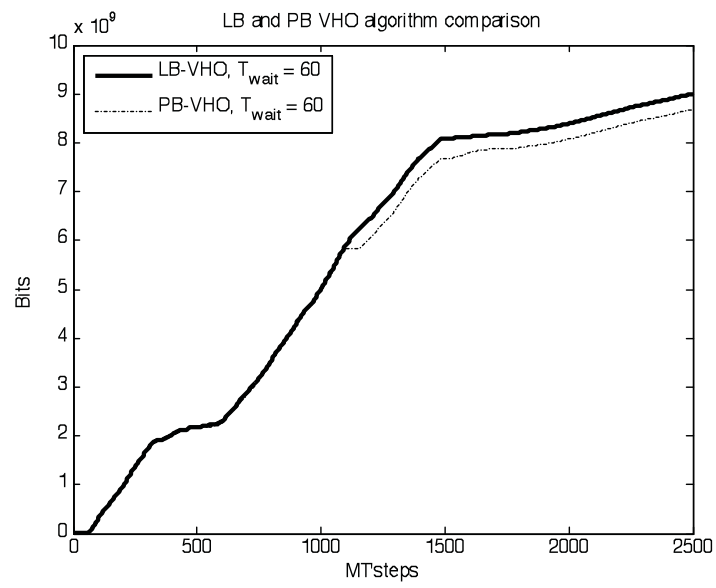

Figure 2.12: CRB during a simulated scenario with PB and LB-VHO approaches, for  $T_{wait} = 0$  s.





**Figure 2.13:** CRB during a simulated scenario with PB and LB-VHO approaches, for  $T_{wait} = 60$  s.

## 2.6 Hybrid schemes for Mobile-Controlled handover

VHO process aims at to guarantee seamless connectivity between heterogeneous wireless networks, inside overlapping areas where the simultaneous coverage from multiple networks is assured. Selection of the serving network can be based on an optimality criterion accounting for price as well as Quality-of-Service (QoS). To allow the selection of the network with the best trade off between cost and local ad overall quality of service, while assuring high service continuity, fast and reliable procedures for the replacement of the serving network in case of link loss or degradation is required.

Different wireless networks exhibit quite different data rate, data integrity, transmission range, transport delay. As a consequence, direct comparison between different wireless links offering connectivity to a MT is not straightforward. In many cases VHO requires a preliminary definition of performance metrics for all the visited networks which allows to compare the QoS offered by each of them and to decide for the best.

VHO decisions can rely on wireless channel state, network layer characteristics and application requirements. Various parameters can be taken into account, for example: type of the application (*e.g.* conversational, streaming, interactive, background), minimum bandwidth and maximum delay, bit error rate, transmitting power, current battery status of the MT as well as user's preferences.

In this Section a novel *mobile-controlled reactive hybrid* VHO scheme (HVHO) is illustrated, where VHO decisions are based on an integrated approach using three components: (i) power map building, (ii) power-based (PB) VHO, and (iii) location-based (LB) VHO.

As known, handover procedures typically are split into two main classes, *i.e.* Mobile Ter-

minimal Controlled Handover (MCHO), and Network-Controlled Handover (NCHO), where the HO procedure is initiated and controlled by the MT or by the network, respectively [19]. MCHO is the most common case for WLAN environments while NCHO is generally the choice for cellular networks to resource optimization and load management, [19]. The same two approaches can be used to distinguish two broad classes of VHO as well.

VHO categories can be also classified on the basis of the criterion adopted for handover decision, in particular:

1. RSS-based VHO algorithms use the classical Received Signal Strength (RSS) parameter to initiate the handover procedure, [1];
2. QoS-based VHO algorithms decide on the basis of the overall quality assessment for the available networks, [20];
3. Signal-to-Noise and Interference Ratio (SINR) algorithms consider the SINR parameter to switch from a Serving Network (SN) to a Candidate Network (CN), [21, 3];
4. Location-based VHO algorithms select the serving network on the basis of the distance between the MT and the BS, [22].

RSS-based VHO is the simplest solution: whenever the measured RSS of the serving network drops below a threshold proportional to the receiver sensitivity, the system attempts an handover using the information on the received power from candidate networks in order to select the new network to migrate to. It constitutes a reactive approach aiming to compensate for performance degradation whenever this reaches a guard threshold.

QoS-based VHO constitutes a preventive approach based on the continuous assessment of QoS level that can be offered by the current SN, as well as from other CNs. It attempts to select the best network at any time thus preventing performance degradation and sudden lack of connectivity. It can be based on the estimation of a set of parameters such as throughput and bit error rate that allow to assess a specific objective QoS metric. Its effectiveness is directly coupled with the ability of objective QoS metric to mimic subjective Quality of Experience and on the accuracy of the parameters on which the metric is based. As illustrated in [20], QoS-based VHO is well suited for multimedia applications like real-time video-streaming. As a drawback, preventive approaches may give high handover frequency and algorithmic instability.

The handover margin, that represents the gap from two consecutive vertical handovers employed in hysteresis based logic, is crucial to handover performance. As a matter of fact, if the margin is too small, numerous unnecessary handovers may be processed; while if the margin is too large, the QoS decreases and calls can be dropped. For RSS-based VHO, the fluctuations of signal strength associated with shadow fadings sometimes cause a call to be repeatedly handed over back and forth between overlapping networks.

Many handover algorithms incorporate a hysteresis cycle within handover decisions so as to prevent an MT to trigger repeatedly undesired handover attempts from a network to another (*ping-pong* effect). Various solutions can be used to mitigate this phenomenon, *e.g.* by using thresholds on vertical handover frequency, as well as hysteresis cycles [23].

In [21], Yang *et al.* consider the SINR factor for VHO decision, as affecting the data rate. When data rate of the CN decreases, the QoS level to guarantee to a MT decreases

too. A SINR-based VHO supports multimedia QoS, and provides seamless handoff with adaptive data rate, as described in [21].

A table lookup approach is proposed in [24] and determines handover margins based on the MT's location, the mean of the intensity of the signal and the standard deviation tradeoff. Then, handover decision mechanism can start when the MT is located in an area with a predefined handover scenario [25]. Anyway, in [24] the computational complexity of making a handover decision is excessive, and establishing and updating a lookup table to support a handover margin decision is time-consuming. The selection of a handover algorithm is based on a comparison of handover scenario with one of the pre-classified environments. It also relies on an updated database when applied in a new mobile user environment.

In Location-based VHO solutions, location information is exploited to assess the performance of the link between SN and MT and predict its future evolution some extent on the basis of its predicted path, [22]. Obviously, knowledge of the current MT location can be used to further enhance RSS-based and QoS-based approaches. In proactive location-aware VHO techniques, prediction of MT's position is expected to be evaluated. In [22], a predictive framework was developed, based on the assumption that the randomness of the user mobility implies an uncertainty of his future location, increasing with the extension of the prediction interval. User position can be determined in several ways [26], including time of advance, direction of arrival, RSS, and A-GPS (Assisted-Global Positioning System).

A preventive approach oriented to optimize QoS is however more prone to high handover frequency and algorithmic instability.

This paper proposes an improved handover algorithm based on an hybrid approach, that is the RSS and the Location-based VHO algorithms. In particular, the RSS VHO approach is used in order the MT takes knowledge of the environment it is, (*i.e.* received power levels and network channel estimations) [1]. Then, the estimate of MT's location is performed by channel QoS level estimation.

### 2.6.1 Vertical Handover approaches

In [27], we have proposed a hybrid HVHO algorithm for dual-mode MTs provided with an UMTS, and a Wi-Fi NIC, exploiting RSS, MT's location, and goodput estimation. The procedure is mobile-driven, soft and includes measures to limit the *ping-pong* effect in handover decisions.

The HVHO approach proceeds in two phases. Namely, in the initial learning phase when the visited environment is unknown, the RSS based approach is used, *i.e.* hereafter referred to as Power-Based (PB) mode. In the meanwhile, the MT continuously monitors the strength of the signals received from the SN as well as from the other candidate networks and, combining RSS with location data provided by the networks or some auxiliary navigation aids, like GPS, builds a path losses map for each network serving the visited environment. At the end of this phase the MT enters the Location based (or LB-mode state), and it can exploit the path losses map to take handover decision using its current location.

Namely, knowledge of the expected spatial distribution of the power attenuation in the surrounding area of the current location allows taking more accurate and stable estimates of the achievable goodput. The handover algorithm used in this phase is then called *Power*

and *Location-Based* (PLB) vertical handover (VHO).

When the MT moves towards new unvisited zones, new *Attenuation Maps* have to be built, and hence the MT enters the PB mode. It will enter the LB-mode again once the updated *Attenuation Maps* have been created. Figure 2.14 depicts the essentials of the HVHO, which operates essentially in the two modes just described. In the PB mode the MT employs a simple VHO (PB-VHO) algorithm, and acquires knowledge of the visited network (*Attenuation Map Building*). In the LB-mode it relies on a more elaborate VHO algorithm (PLB-VHO), while it keeps refining its knowledge of the visited environment (*Attenuation Map Update*).

In the following Subsection 2.6.2 we are presenting the PB-mode, and in Subsection 2.6.3 we describe the process for *Attenuation Map Creation* and *Update*, respectively.

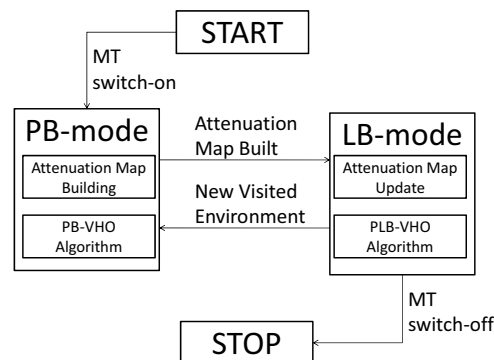

**Figure 2.14:** Finite State Machine for Hybrid Vertical Handover Algorithm.

## 2.6.2 Power-based VHO for Hybrid VHO technique

From mobile switch-off up to the completion of both UMTS and Wi-Fi *Attenuation Map Building*, the mobile terminal uses the PB-VHO approach to provide seamless connectivity

and assure a basic connectivity recovery algorithm, with minimal computational cost. With the PB-VHO scheme the MT selects an access network, either UMTS or Wi-Fi, and keeps it till the received power drops below the receiver sensitivity. Then, the other network is scanned in order to verify if it can serve the MT and a handover can be successfully done.

Figure 2.15 shows the flowchart of the PB-VHO algorithm. When the MT switches on, it attempts selecting the Wi-Fi interface. Namely, if the power  $P_W$  measured by the Wi-Fi NIC is above the Wi-Fi receiver sensitivity  $P_{W-\min}$ , the Wi-Fi connectivity is judged feasible and the Wi-Fi network is selected. Otherwise, if the power  $P_U$  measured by the UMTS NIC is above the UMTS receiver sensitivity  $P_{U-\min}$ , the UMTS network is selected. When both tests fail, the terminal pauses for  $T$  seconds before a new attempt is made. Once, in the end, a network is selected, every  $T$  seconds a new power scanning is performed to regularly monitor network availability and detect received power falling below the sensitivity level.

Scanning frequency is upper bounded by fixing a minimum latency parameter between consecutive VHOs, *i.e.* the waiting time  $T$  [s], in order to preserve battery charge as well as to limit the *ping-pong* effect. Availability of a power *Attenuation Map* derived from RSS measures makes it possible to apply a more sophisticated method for handover management and optimize goodput without waiting for severe performance degradation prior handover initiation.

### 2.6.3 Attenuation Map Building and Update

When the MT is switched on, the new environment is scanned in order to learn about the available UMTS and Wi-Fi connectivity. This is given by a power *Attenuation Map*, which



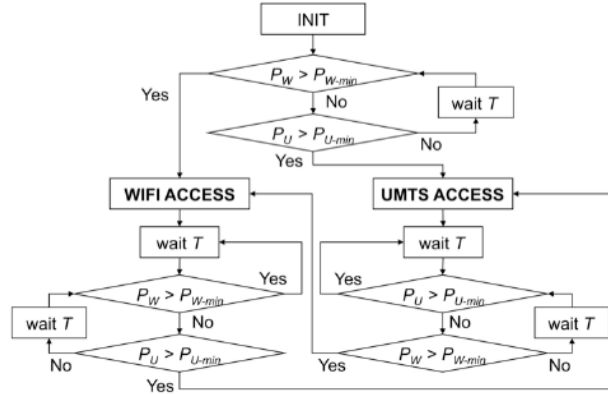

Figure 2.15: PB-VHO Flowchart.

is built for each of the networks.

The spatial distribution of the power attenuation associated to the monitored UMTS and Wi-Fi access points are obtained simply as the difference between the access point transmission power and the estimated local RSS, *i.e.* by taking the difference between the nominal transmitted power and the short term time average of the RSS. Averaging is required in order to smooth fast fluctuations produced by multipath signal reflections, and can be performed by means of a mean filter applied to the attenuation sample series multiplied by a sliding temporal window.

Let us assume that the mobile terminal is moving in an area partitioned into a lattice of  $\tilde{M}_H \times \tilde{M}_V$  square zones, each with a width  $w_{zone}$ . In general, this parameter is different for UMTS and Wi-Fi networks, in accordance to the maximum rate of change of the received power signals. While moving in that area, the MT measures the attenuation in each visited zone and associates it with its current location.

Let  $n$  be the discrete time index and  $a_j[n]$  be the attenuation measured in the  $j$ -th

zone at time  $n$ . Then, the Moving Average estimate  $A_j[n]$  of the attenuation on a sliding window of length  $K$  is,

$$A_j[n] = \frac{1}{K} \sum_{i=n-K+1}^n a_j[i], n \geq K. \quad (2.34)$$

Averaging over the last  $K$  samples allows reducing the impact of instantaneous power fluctuations in attenuation detection, and reduces the power error estimation. On the other hand, as the mobile terminal is assumed to be moving, the length of the moving window cannot be too large. As an alternative, an Exponential Smoothing filter with time constant  $\tau$  can be applied, so that:

$$A_j[n] = \alpha \cdot A_j[n-1] + (1 - \alpha) \cdot a_j[n], \quad (2.35)$$

where  $\alpha = \exp\left(-\frac{t_n - t_{n-1}}{\tau}\right)$ .

Although (2.34) and (2.35) have the same computational cost and similar performance, (2.35) requires smaller quantity of memory to store the measured time series  $a_j[n]$ . Furthermore, since Moving Average filters are prone to outliers, a more robust estimate can be computed by replacing the linear mean filter with a (non-linear) median filter.

When each zone of the lattice has been visited at least once, the *Attenuation Map* is completed. However, it is possible that a complete visit of all the zones of the map can take a long time, and perhaps it never ends. As a consequence, in order to speed up the *Attenuation Map Building* process we resort to interpolation in order to assign an attenuation value to locations that have not yet been visited.

Namely, let us assume that the  $j$ -th zone, with center in  $(x_j, y_j)$ , has not been assigned a power value yet, and let  $j_1, j_2$  and  $j_3$  be the nearest three locations whose attenuation has already been measured. We can estimate the attenuation  $A_j$  of zone  $j$  by applying

linear algebra and using the equation of a plane passing through three points:

$$\det \begin{pmatrix} x_j - x_1 & y_j - y_1 & A_j - A_1 \\ x_2 - x_1 & y_2 - y_1 & A_2 - A_1 \\ x_3 - x_1 & y_3 - y_1 & A_3 - A_1 \end{pmatrix} = 0. \quad (2.36)$$

Through simple manipulation of (2.36), we can easily obtain a direct formula for interpolation of  $A_j$

$$\begin{aligned} A_j &= \frac{A_2(x_3y_1 - x_jy_1 - x_1y_3 + x_jy_3 + x_1y_j - x_3y_j)}{x_3(y_1 - y_2) + x_1(y_2 - y_3) + x_2(-y_1 + y_3)} + \\ &+ \frac{A_1(-x_3y_2 + x_jy_2 + x_2y_3 - x_jy_3 - x_2y_j + x_3y_j)}{x_3(y_1 - y_2) + x_1(y_2 - y_3) + x_2(-y_1 + y_3)} + \\ &+ \frac{A_3(x_jy_1 + x_1y_2 - x_jy_2 - x_1y_j + x_2(-y_1 + y_j))}{x_3(y_1 - y_2) + x_1(y_2 - y_3) + x_2(-y_1 + y_3)}. \end{aligned} \quad (2.37)$$

It is worth highlighting that linear interpolation through (2.36) brings some errors in the *Attenuation Map*. In general, a sufficient number of visited zones have to be achieved prior completion of the *Attenuation Map*. Such a number is also dependent on the actual path of the MT in the lattice.

Let  $VZ[n]$  be the set of visited zones up to time  $n$  in a neighborhood of the MT location at time  $n$ . Then, in order to evaluate the degree of reliability of the *Attenuation Map* at time  $n$ , we employ a *Map Reliability Index (MRI)* at time  $n$ , defined as follows:

$$MRI[n] = \frac{\|VZ[n]\|}{\tilde{M}_H \cdot \tilde{M}_V}, \quad (2.38)$$

where  $\tilde{M}_H \cdot \tilde{M}_V$  is the total number of zones in the neighborhood. We empirically set a threshold value  $MRI^{TH}$  for the index in (2.38) beyond which the knowledge of the visited environment is regarded as acceptable and interpolation is applied. Only when this threshold is exceeded, interpolation is applied.

Thus, the *Attenuation Map* will be filled in partially with measured attenuations and partially through linear interpolation.

To speed up the transient phase and to enhance estimation accuracy, *Attenuation Maps* could also be broadcast by the access nodes themselves, using a common control channel, on the basis of the measures reported by each visiting node.

Even after *Attenuation Map Completion*, when the MT enters the LB-mode (Figure 2.14), power samples continue being collected and used as in (2.35) in order to increase the accuracy of each map (*Attenuation Map Update*). Conversely, when for the current location the *MRI* falls below  $MRI^{TH}$  a transition from the LB-mode to the PB-mode is performed (Figure 2.14).

#### 2.6.4 Power and Location-based (PLB) VHO for non-isotropic cells

In the location-based approach presented in [2] the goodput is estimated simply on the basis of the distance  $d$  from the center of a wireless cell. This method is applicable when the coordinates of the center of the cells and the cell range are known a priori.

In addition, this goodput model assumes an isotropic access point source, and no obstacles between the MT and the access point. In this Section we will exploit the *Attenuation Map Building* phase, in order to derive a more realistic estimate of the goodput by relaxing the hypothesis of isotropic cells. In order to exploit the PLB-VHO approach, it is first necessary to obtain (i) a goodput estimation approach adapted for anisotropic cells, and (ii) a method to derive wireless cell geometry from the *Attenuation Map Building*, as described in Section 2.6.3.

We assume a generic-shape cell model and estimate goodput as a function of the MT's

line of sight direction  $\alpha$ , (*i.e.*, the direction of the line drawn from the access point location  $P_c = (x_c, y_c)$  to the MT current position  $P_M = (x_M, y_M)$ , as shown in Figure 2.16). Namely,  $\alpha$  is calculated as follows

$$\alpha = \arctan \left( \frac{y_M - y_c}{x_M - x_c} \right).$$

For a cell with access point placed in  $P_c$ , we define the radius of the cell  $R_{cell}$  as a function of the line of sight  $\alpha$ , which represents the distance  $R_{cell} = R_{cell}(\alpha; P_c)$  from the cell centre along the line of sight  $\alpha$  beyond which the outage probability exceeds the maximum acceptable value  $\tilde{P}_{out}$ .

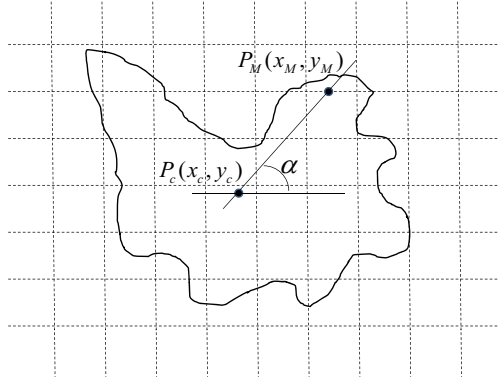

**Figure 2.16:** Anisotropic cell model.

Hence, the goodput  $GP^{(k)}(d_{(k)}, \alpha_{(k)})$  at distance  $d_{(k)}$  along the line of sight  $\alpha$  can be calculated for each zone with the following approximated formula,

$$GP^{(k)}(d_{(k)}, \alpha_{(k)}) = BW_{\max}^{(k)} \cdot \Pr \left\{ d_{(k)} < R_{cell}^{(k)}(\alpha; P_c) \right\}, \quad (2.39)$$

where  $k$  denotes the corresponding wireless network, *i.e.*  $k \in \{UMTS, WiFi\}$ . Handover decisions are then taken on the basis of

$$GP_{\max}^{UMTS}(d_{(k)}, \alpha_{(k)}) < GP_{\max}^{WiFi}(d_{(k)}, \alpha_{(k)}). \quad (2.40)$$

We can calculate the function  $R_{cell}^{(k)}(\alpha; P_c)$  by using the *Attenuation Map*. In fact, for a given direction  $\alpha$ , we can consider the set of zones lying along the corresponding line of sight. Using (2.36) the attenuation profile along the line of sight can be easily computed. Then, the cell range along direction can be set to the distance for which the attenuation equals to the maximum attenuation  $A_{\max}$ , beyond which the outage probability exceeds the maximum acceptable value  $\tilde{P}_{out}$ .

In addition, in zone  $Z_j$  with center in  $(x_j, y_j)$  characterized by an attenuation the average goodput can be evaluated as

$$GP^{(k)}(d_{(k)}, \alpha_{(k)}) = BW_{\max}^{(k)} \cdot \Pr \left\{ A_j^{(k)} < A_{\max}^{(k)} \right\}, \quad (2.41)$$

where  $\Pr \left\{ A_j^{(k)} < A_{\max}^{(k)} \right\}$  is obtained as an analogy from  $\Pr \left\{ d_{(k)} < R_{cell}^{(k)}(\alpha; P_c) \right\}$ .

## 2.7 Considerations about HVHO algorithm

Collected simulation results are presented in [27], in order to compare performance of the three VHO approaches, *i.e.* PB, LB and PLB-VHO. Basically, simulated trends for such algorithms represent three different realistic cases in a dual-mode Wi-Fi/UMTS MT using in turn one of the three algorithms.

Performance of the three algorithms are evaluated in terms of the number of the executed vertical handovers vs. the *waiting time* parameter. As expected, the number of VHOs obtained with the PB-VHO is significantly lower than that of the LB-VHO and PLB-VHO, whose curves are roughly overlapping. This means that performance optimization pursued by PLB-VHO and LB-VHO is achieved at the expenses of an increase handover frequency.

In addition, it is worthwhile to notice that the algorithmic enhancement to the LB approach (combination of location information and power measures to obtain anisotropic cells) has not brought to instability.

Namely, the HVHO develops a location-based approach to build and maintain a power *Attenuation Map* providing updated description of the wireless cells in the visited environment.

## 2.8 Data Rate-based Vertical Handover

As discussed in previous Sections 2.4 and 2.5, many approaches are used to vertical handover from a Serving Network (SN) to a Candidate Network (CN), with the goal of provide a maximization of throughput, and a limitation of unwanted and unnecessary vertical handovers.

Normally, a handover initiation is typically driven on traditional RSS parameter, though it does not give good performance for MT wide QoS requirements [1]. Also the SINR parameter is particularly used as a metric in order to provide seamless handover with adaptive Data Rate (DR), as described in [21], while information about MT's location [2] or monetary cost [28] can be used to preventive VHOs.

Combination of the above metrics can generate most effective VHO decisions, called as hybrid VHO approaches, and based on two or more metrics, such as the RSS and the distance information between a BS and a MT [29]. In [30] a VHO decision function is obtained as a composition of the monetary cost, power requirements, security parameters, MT preference, network conditions, and MT's speed. Then, in [21] the authors address on

the SINR parameter as VHO metric, but do not consider it as hybrid vertical handover criterion.

In this Section, we consider the main physical parameters (*i.e.* RSS, SINR and DR) be opportunistically mixed in a hybrid VHO approach, in order to improve end-user QoS.

A comparison between three different Vertical Handover Decision Functions (VHDFs), based on single and combined VHO decision metrics, has been evaluated. Single metrics are respectively based on RSS and DR, while the combined one is a contribution of RSS plus SINR and DR parameters.

In next Subsection 2.8.1, we introduce both the single-metric based VHDFs (*i.e.* called as RSS-VHDF, and DR-VHDF), while in Subsection 2.8.3 the combined-metric based VHDF (C-VHDF) is proposed. Effectiveness of C-VHDF is tested in terms of maximization of cumulative received bits, and limitation of number of VHOs.

### 2.8.1 Single-Metric Based VHDF

We present two VHDFs based on single metrics, such as the RSS and DR parameters, respectively.

#### **RSS-VHDF**

The RSS-VHDF is based on RSS parameter, measured by different MT's Network Interface Cards (NICs).

Let us assume that a MT is moving in an outdoor heterogeneous network environment, composed by different network hot-spots (*i.e.* UMTS macrocells, and Wi-Fi microcells). The MT moves at low speed, and in each position it can receive the RSS parameter by the



SN, and measures the RSS parameter by a CN, if available.

Without loss of generality, we can assume that UMTS is the SN, and WIFI a possible CN. The RSS-VHDF performs a power monitoring of the SN at regular intervals of times, (*i.e.* *waiting time* [s]), in order to limit both the battery life of the MT and the number of vertical handovers [1, 2]. The main steps of RSS-VHDF are the following:

1. **First VHO alarm:** when the RSS level from the SN is decreasing under a fixed value (*i.e.*  $P_{SN} < S_{SN} + Th_1$ ), a first VHO alarm is given by the MT. Basically,  $S_{SN}$  is the MT's sensibility for a particular SN, and  $Th_1$  a threshold to avoid unexpected connection interruptions;
2. **Network discovery:** after the first VHO alarm has occurred, the network discovery is initiated in order to find an available CN to handover to;
3. **Power Testing:** if a CN is available and its RSS parameter is higher than a VHO threshold (*i.e.*  $P_{CN} > H_{CN-VHO}$ ), the channel estimation phase starts;
4. **Channel estimation:** the channel estimation is evaluated when the MT requires a QoS enhancement. The goodput parameter is instantaneously estimated (*i.e.* exponential smoothing average), both for the SN and the CN (*i.e.*  $GP_{SN}$ , and  $GP_{CN}$ , respectively). If  $GP_{CN} > GP_{SN}$ , a VHO is performed; otherwise the MT will repeat this phase later, after waiting  $T_{wait}$  seconds [1, 2];
5. **Idle mode:** just after a VHO occurrence, the MT is in idle mode for at least the waiting time parameter  $T_{wait}$ . The values of  $T_{wait}$  are independent on network technology.

The RSS-VHDF approach is described in Figure 2.17. The power testing phase is the core of RSS-VHDF, as a VHO occurs only if the CN's RSS parameter exceeds a VHO threshold, *i.e.*  $P_{CN} > H_{CN-VHO}$ . It represents a necessary condition for VHO execution, and after this a channel estimation is performed [1].

If the power testing phase is not verified, no VHO will be executed. Basically, the RSS-VHDF performs the goodput estimation in order to guarantee a QoS improvement by switching in a CN. The waiting time parameter is introduced to limit the *ping-pong* effect.

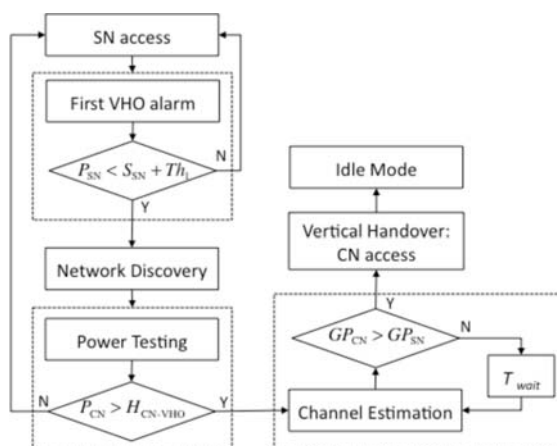

Figure 2.17: Decision tree for RSS-VHDF approach.

## DR-VHDF

The DR-VHDF approach is based on DR parameter, measured in the SN and the available CN. A VHO occurs when the connectivity switching can assure a data rate gain (*i.e.*  $R_{gain}$ ). This parameter is similar to the goodput estimation in RSS-VHDF, but it represents an

instantaneous measurement, and not an estimation.

Basically, as the SINR parameter is strictly dependent on the data rate  $R$  [Mbit/s],  $R_{gain}$  is obtained by a comparison between data rate parameter in the SN and that in the CN. The SINR parameter in Wi-Fi network represents the ratio between the signal received by the  $i$ -th MT from  $j$ -th Wi-Fi AP, and that of all other interfering signals plus background noise power at MT receiver end, (*i.e.*  $P_B$ ) [21]:

$$SINR_{j,i}^{Wi-Fi} = \frac{G_{j,i}^{Wi-Fi} P_j^{Wi-Fi}}{P_B + \sum_{\substack{k \in Wi-Fi \\ k \neq j}} G_{k,i}^{Wi-Fi} P_k^{Wi-Fi}}, \quad (2.42)$$

where  $P_j^{Wi-Fi}$  is the transmitting power of  $j$ -th Wi-Fi AP, and  $G_{j,i}^{Wi-Fi}$  is the channel gain between  $i$ -th MT and  $j$ -th WIFI AP. Analogously, in UMTS network the SINR parameter is expressed as, [21]

$$SINR_{j,i}^{UMTS} = \frac{G_{j,i}^{UMTS} P_{j,i}^{UMTS}}{P_B + \sum_{k \in UMTS} \left( G_{k,i}^{UMTS} P_k^{UMTS} \right) - G_{i,j}^{UMTS} P_{j,i}^{UMTS}}, \quad (2.43)$$

where  $P_k^{UMTS}$  is the total transmitting power of the  $k$ -th UMTS BS,  $P_{j,i}^{UMTS}$  is the transmitting power of the  $j$ -th UMTS BS to the  $i$ -th MT, and  $G_{j,i}^{UMTS}$  is the channel gain between the  $j$ -th UMTS BS and the  $i$ -th MT.

From (2.42) and (2.43), it derives the maximum achievable data rate  $R_{j,i}^{Wi-Fi,UMTS}$  for the  $i$ -th MT connected with the  $j$ -th UMTS BS, and Wi-Fi AP, respectively.

Then, by considering the downlink transmission from the AP/BS to the MT, respectively for WIFI and UMTS networks, for a given carrier bandwidth  $W$ , and by Shannon capacity

formula, the data rate expression can be written as, [31, 32]

$$R_{j,i}^{\text{Wi-Fi,UMTS}} = W \log_2 \left( 1 + \frac{\text{SINR}_{j,i}^{\text{Wi-Fi,UMTS}}}{\Gamma_{\text{Wi-Fi,UMTS}}} \right), \quad (2.44)$$

where  $\Gamma$  represents the channel coding loss factor [dB]. For Wi-Fi and UMTS networks, we consider  $W_{\text{WIFI}} = 22$  MHz [31], and  $W_{\text{UMTS}} = 5$  MHz [32], while the parameters  $\Gamma_{\text{Wi-Fi}}$  and  $\Gamma_{\text{UMTS}}$  correspond to 3 dB [31] and 12 dB [32], respectively.

In order to assure service continuity, the data rates from two different networks have to be the same or differ of a bandwidth gain value  $R_{\text{gain}}$  [Mbit/s]. As an example, if we consider a handover from UMTS to Wi-Fi, data rate comparison is given by

$$R_{j,i}^{\text{Wi-Fi}} \geq R_{j,i}^{\text{UMTS}} + R_{\text{gain}}^{\text{Wi-Fi}}, \quad (2.45)$$

where  $R_{\text{gain}}^{\text{Wi-Fi}}$ , represents the data rate gain when moving from the UMTS to the Wi-Fi network. Again, in case of a handover from Wi-Fi to UMTS, the data rate condition will be:

$$R_{j,i}^{\text{UMTS}} \geq R_{j,i}^{\text{Wi-Fi}} + R_{\text{gain}}^{\text{UMTS}}, \quad (2.46)$$

where  $R_{\text{gain}}^{\text{UMTS}}$  represents the data rate gain when moving from the Wi-Fi to the UMTS network. Hence, in both types of transitions, a vertical handover occurs only if the network switching can offer a gain of data rate. The data rate gain for VHO from UMTS to Wi-Fi has been set equal to that from Wi-Fi to UMTS, (*i.e.*  $R_{\text{gain}}^{\text{UMTS}} = R_{\text{gain}}^{\text{Wi-Fi}}$ ), for different values, in order to be VHO type independent.

The overall DR-VHDF process is illustrated in Figure 2.18. This approach has main analogies with RSS-VHDF, but the VHO decision that is based on a data rate gain.

Just after the first VHO alarm and the network discovery, like in RSS-VHDF, the DR-VHDF introduces the Data Rate gain phase, as a VHO decision criterion. No power testing phase is considered because the metric is different. The core step of DR-VHDF is the Data Rate gain, whose condition is expressed by (2.45) and (2.46), when UMTS is the SN, and WIFI the CN, and vice versa.

Briefly, the following steps compose the DR-VHDF algorithm:

1. **First VHO alarm:** as in RSS-VHDF;
2. **Network discovery:** as in RSS-VHDF;
3. **Data rate gain:** if a CN is available, a data rate comparison is performed between SN and CN. If condition (2.45) or (2.46) occurs (*i.e.* depending if Wi-Fi is the CN and UMTS the SN, and vice versa), a VHO is initiated to the CN;
4. **Idle mode:** as in RSS-VHDF.

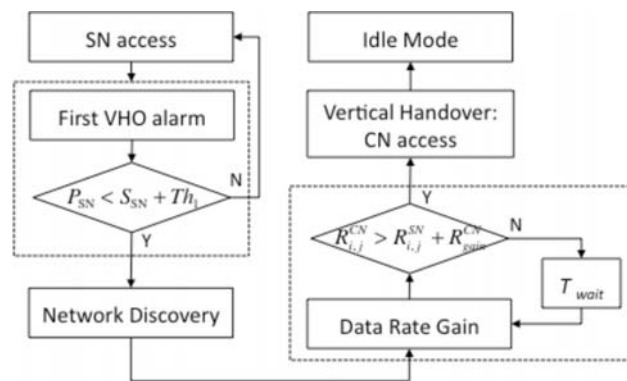

**Figure 2.18:** Decision tree for DR-VHDF approach.

### 2.8.2 Combined-Metric Based VHDF

In the C-VHDF, the combined metric is based on the power control and the data rate gain; the first is typical from RSS-VHDF, the latter from the DR-VHDF. In this way, a VHO is performed if the power testing is verified according, and then a data rate gain is assured by the CN, as expressed in (2.45) or (2.46).

The C-VHDF process is depicted in Figure 2.19. The combined RSS and DR metrics avoid reducing the VHO frequency thought maximize network performance. The main steps are:

1. **First VHO alarm:** common to RSS and DR-VHDF;
2. **Network discovery:** common to RSS and DR-VHDF;
3. **Power testing:** common to RSS-VHDF;
4. **Data Rate gain:** common to DR-VHDF;
5. **Idle mode:** common to RSS and DR-VHDF.

### 2.8.3 VHDF Comparison

In the comparison between VHDFs, we considered the following parameters listed in Table 2.2. Moreover, the interference power is 40% in Wi-Fi channel, while the ratio of total allocated BS transmits power to UMTS channel is 80%, respectively.

For the VHO thresholds  $H_{\text{CN-VHO}}$  for Wi-Fi and UMTS, we respectively set  $-94$  dBm and  $-97$  dBm, values greater than the sensitivity parameter. Finally, the RSS-VHDF

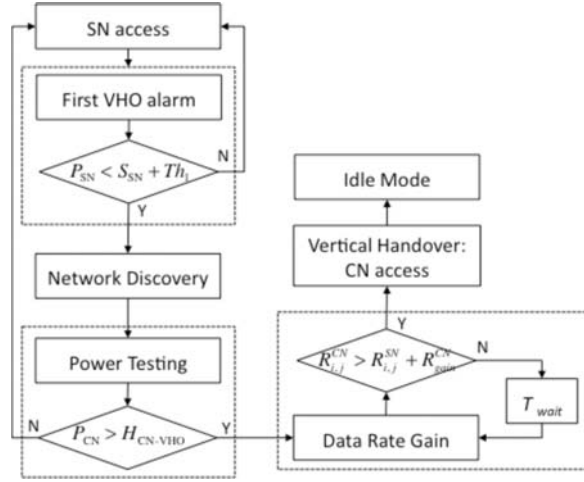

**Figure 2.19:** Decision tree for C-VHDF approach.

performances are obtained by an exponential smoothing average channel bandwidth estimation [1], while for DR and C-VHDF we considered  $R_{gain}^{Wi-Fi/UMTS} = 0.3, 0.5, 0.7, 0.9$ , and 1 Mbit/s.

Parameter	Network 1	Network 2
Capacity [bits/s]	$1 \cdot 10^6$	$1 \cdot 10^6$
Cell radius [m]	600	120
Sensitivity [dB]	-100	-100
Maximum Tx Power [dBm]	43	20
Receiver gain [dB]	2	2
Transmission gain [dB]	2	2
Carrier Frequency [Hz]	2400	2400

**Table 2.2:** Simulated scenario setup.

The RSS-VHDF performs a goodput estimation in order to make a vertical handover. The estimated goodput gain is  $GP_{gain}$  and represents the ratio  $GP_{CN}/GP_{SN}$ , (*i.e.* in the

simulations we considered  $GP_{gain} = 0.3, 0.5, 0.7, 0.9$ , and 1).

The maximization of system performance (*i.e.* CRBs) shows the effectiveness of CVHDF algorithm. As a matter of fact, the average of CRBs sampled at the 2500-th step for C-VHDF has low different values, for each value of waiting times and data rate gains DR and RSS-VHDF have high different values, decreasing for increasing values of waiting time parameter, as shown in respectively.

The C-VHDF gives maximum performances, independently of the waiting time parameter. As the tradeoff between maximization of CRBs and restriction of number of VHOs is an issue for VHO management, the single-metric based VHDFs have lower performance than combined-metric based VHDF.

This is shown in Figure 2.20, 2.21, and 2.22 by the average of the number of vertical handovers occurred for the DR, RSS, and C-VHDF vs. the waiting time parameter, respectively. The VHO frequency represents the total amount of VHOs, executed during MT's path. It can be expressed as follows,

$$\varphi_{xVHDF,j} = \sum_{i=1}^N n_i^{VHO}(T_{wait,k}), \quad (2.47)$$

where  $\varphi_{xVHDF,j}$  is VHO frequency for RSS, DR, and C-VHDF, for the  $j$ -th waiting time  $T_{wait,k}$  (*i.e.*  $j = k + 1$ , with  $j \in J, J = 8$ ).

Then,  $N$  is the total number of steps of the MT's path (*i.e.*  $N = 2500$ ). The value of  $n_i^{VHO}$  is 1 if a VHO has occurred in the  $i$ -th step, 0 otherwise. The higher the VHO frequency the lower the waiting time parameter (*i.e.*  $j = 1$ ), and vice versa (*i.e.*  $j = 8$ ).

Figure 2.20 shows that the CVHDF strongly reduces the *ping-pong* effect, but maintains high CRB values.



Let us consider the following parameter as an indicator of VHO frequency:

$$\Delta\varphi_{x\text{VHDF}} = \varphi_{x\text{VHDF},1} - \varphi_{x\text{VHDF},8}. \quad (2.48)$$

It represents the VHO frequency band, that is the range of all possible values of VHO frequency for a particular VHDF. It is obtained as the difference between the maximum and minimum value of averaged VHO frequency.

From Table 2.3, we get that for RSS and C-VHDF the frequency bands are equal to five, *i.e.*  $\Delta\varphi_{\text{RSS-VHDF}} = \Delta\varphi_{\text{C-VHDF}} = 5$ , while the  $\Delta\varphi_{\text{DR-VHDF}} = 32$ , a very wide band.

For the same value of data rate gain (*i.e.* 0.5 Mbit/s), CVHDF has lower number of VHOs than that for DR-VHDF. The C-VHDF algorithm never joins the minimum number of VHOs reached by DR-VHDF, independently of the waiting time parameter. As a matter, the range of VHO frequencies for C-VHDF is around [1, 5], while for DR-VHDF is [13, 45]. This proves the effectiveness of a combined VHO approach, respect to a single criterion-based algorithm, while keeping high network performance.

The worst case for C-VHDF is obtained for  $R_{\text{gain}} = 0.5$ , as the VHO frequency is around 5, and the CRBs are higher than 8 Gbit/s. The same value of CRBs is obtained by DR-VHDF for  $R_{\text{gain}} = 0.5$  and  $\varphi_{\text{DR-VHDF},1} = 44$ ; while the RSS-VHDF reaches 8 Gbit/s for  $R_{\text{gain}} = 0.5$  and  $\varphi_{\text{RSS-VHDF},6} = 8$ .

	$\varphi_{\text{RSS-VHDF},j}$	$\varphi_{\text{DR-VHDF},j}$	$\varphi_{\text{C-VHDF},j}$
$j = 1$	12	45	5
$j = 6$	7	13	1

**Table 2.3:** Maximum and minimum values of VHO frequency.

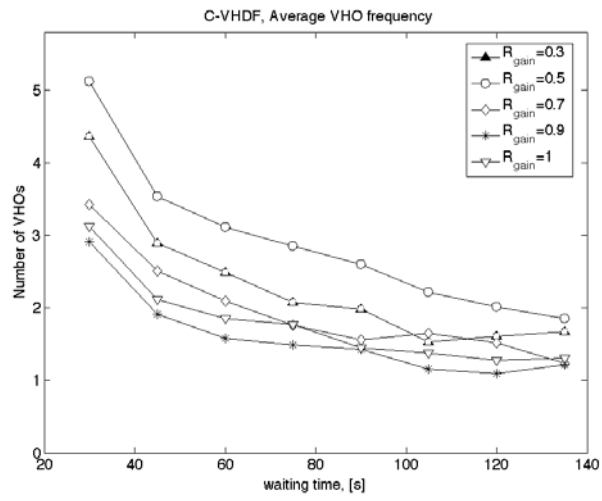

Figure 2.20: Average VHO frequency for C-VHDF.

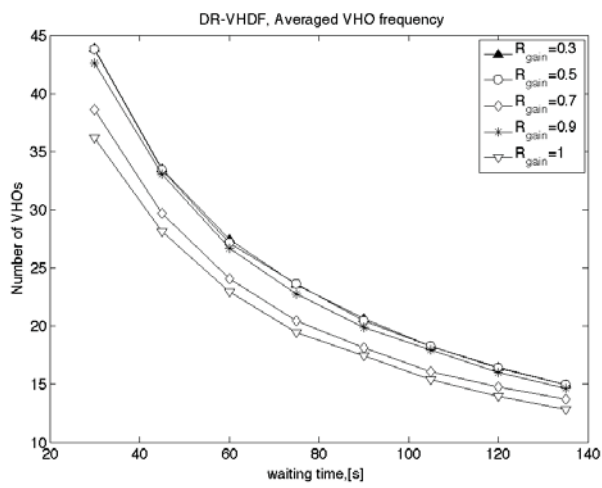

Figure 2.21: Average VHO frequency for DR-VHDF.

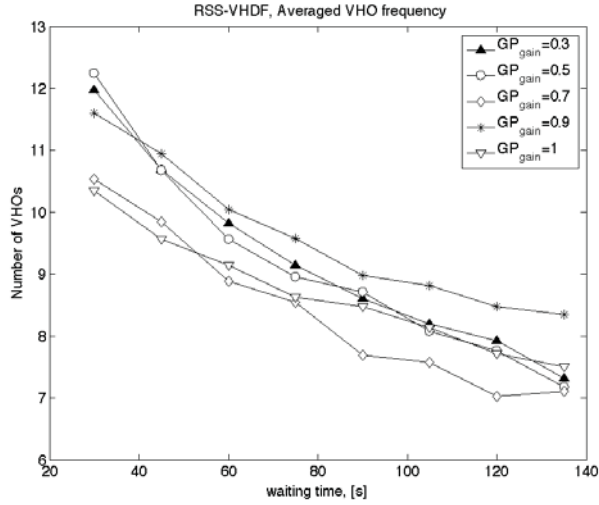

Figure 2.22: Average VHO frequency for RSS-VHDF.

## 2.9 Probability-based Vertical Handover

In the previous Sections, we describes different VHO algorithms based on physical metrics, such as channel estimation [1], localization [2], SINR [3], and QoS [20].

There are also many analytical methods based on a VHO Probability (called as VHP), described in [33, 34]. In [35], Chi *et al.* introduce a VHO decision criterion based on Wrong Decision Probability (*WDP*). Basically, the authors adopt the *WDP* as a VHO decision metric based on network parameters (*i.e.* available bandwidth). *WDP* is also assumed as a performance result for the proposed algorithm. The *WDP* is based on maximum capacity and available bandwidth from a CN. It is not considered how *WDP* probability affects MT's performances in terms of QoS. In this Section, we present an analysis of *WDP* and VHO, based on the goodput performance parameter. The VHO decision is performed in order to limit unnecessary vertical handover occurrences affecting MT performances, (*i.e.*

battery life) [1]. In our proposed *WDP*-based technique a VHO is initiated and controlled by the MT. It is defined as a Mobile Terminal-Controlled Handover scheme [19].

### 2.9.1 WDP Assessment

Let us consider a dual-mode MT moving inside of an area with double radio technology coverage, *i.e.* offering network connectivity thorough either network  $i$  or network  $j$ . A vertical handover scheme between network  $i$  and network  $j$  is adopted in order to assure seamless connectivity in the visited area and optimize network performance. This can be evaluated on the basis of several network parameters, such as transmission delay, error transmission probability, packet loss probability, throughput, and so on. The MT goodput, *i.e.* the application level goodput, is considered as the performance metric to drive handover decisions.

Namely, the purpose of the handover algorithm is to select the network with the higher goodput level at any time. However, handover decisions are taken so as not to cause algorithmic instability and prevent the *ping-pong* effect.

It is assumed that the MT is able to assess the achievable goodput in both network  $i$  and  $j$ , while attached to either network  $i$  or  $j$ , *e.g.* by detecting the carrier-to-noise ratio, and knowing the network load in the current cells of network  $i$  and  $j$ , respectively. Let  $\Delta t$  be a convenient interval of time for goodput estimation in network  $i$  and network  $j$ , supposed equal for both networks. Let us consider the discrete time variable  $k$ , where consecutive instants  $k$  and  $k + 1$  differs of exactly  $\Delta t$  seconds.

Consequently, every instant  $k$  a new assessment of goodput for networks  $i$  and  $j$  is available. A delta goodput stochastic process  $\Delta GP[k]$  can be defined as a function of  $k$ ,

such as:

$$\Delta GP [k] = GP_i [k] - GP_j [k], \quad (2.49)$$

where  $GP_i$  and  $GP_j$  are goodput assessments for network  $i$ , and  $j$ , obtained for every time instant  $k$ , respectively. Let us suppose that at time  $k$ , both  $GP_i$  and  $GP_j$  can assume a maximum value, specific for each radio technologies  $i$  and  $j$ , (*i.e.*  $\max GP_i$  and  $\max GP_j$ ), and a minimum value equal to zero, (*i.e.*  $\min GP_{i,j} = 0$ ) being network capacity always nonnegative and equal to 0 when no connection is available. Therefore, for the  $\Delta GP [k]$  process the maximum and minimum value is calculated as follows:

$$\begin{cases} \Delta GP_{\max} = \max GP_i \\ \Delta GP_{\min} = - \max GP_j \end{cases} \quad (2.50)$$

When the  $\Delta GP [k]$  variable is positive, network  $i$  should be selected by the vertical handover algorithm, as it exhibits better goodput than network  $j$ . A trivial reactive vertical handover scheme could simply select the best network  $i$  or  $j$  at any instant  $k$ , and hence changes network every time the sequence  $\Delta GP [k], k = 0, 1, \dots, \infty$ , changes sign. However, this solution can be subject to instability (*i.e.* *ping-pong* effect) on account of two possible causes:

1. fast changes of signs of the sequence  $\Delta GP [k]$ , when the MT roams in an area where  $GP_i [k] \approx GP_j [k]$ ;
2. low accuracy in the assessment of  $\Delta GP [k]$  samples, (*i.e.* time instants  $k$  sampled at high frequency values).

As a measure to prevent the first cause of instability, we are using the conditional probability density function of  $\Delta GP [k + 1]$  given  $\Delta GP [k]$ . We make the following assumptions

to select a suitable conditional probability density function with variables  $\Delta GP [k]$  and  $\Delta GP [k + 1]$ , when no specific knowledge of the probabilistic behavior of  $GP_i$  or  $GP_j$  is known a priori.

Namely, the function,

- given  $\Delta GP [k] = g^*$ , has a maximum in  $g^*$ ;
- it decreases with the distance from  $g^*$ ;
- it is equal to zero out of the interval  $[\Delta GP_{\min}, \Delta GP_{\max}]$ .

According to previous function characteristics, a linear decrement can be considered as the conditional probability density function with variables  $\Delta GP [k]$  and  $\Delta GP [k + 1]$ . So, a triangular shape with maximum in  $g^*$  will be obtained, as shown in Figure 2.23. Its analytical form is as follows:

$$\begin{aligned}
 p(\Delta GP [k + 1] = g | \Delta GP [k] = g^*) &= \\
 &= \begin{cases} \frac{2(g - \Delta GP_{\min})}{(\Delta GP_{\max} - \Delta GP_{\min})(g^* - \Delta GP_{\min})}, \Delta GP_{\min} < g < g^* \\ \frac{2(g - \Delta GP_{\max})}{(\Delta GP_{\max} - \Delta GP_{\min})(g^* - \Delta GP_{\max})}, g^* < g < \Delta GP_{\max} \end{cases} \quad (2.51)
 \end{aligned}$$

The probability that  $\Delta GP [k + 1]$  is greater than zero, given  $\Delta GP [k] = g^*$  and when  $g^* \leq 0$ , is obtained by integrating (2.51) in the range  $0 \leq g \leq \Delta GP_{\max}$ :

$$\begin{aligned}
 p(\Delta GP [k + 1] > 0 | \Delta GP [k] = g^*) &= \\
 &= -\frac{\Delta GP_{\max}^2}{(\Delta GP_{\max} - \Delta GP_{\min})(g^* - \Delta GP_{\max})}. \quad (2.52)
 \end{aligned}$$

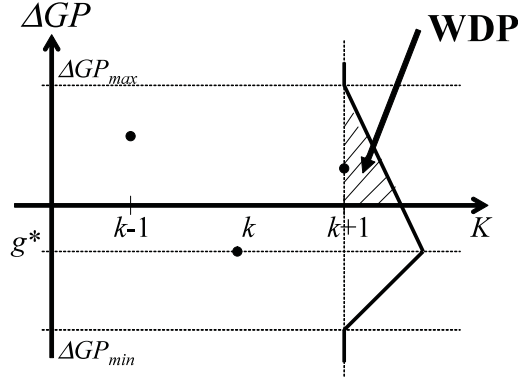

**Figure 2.23:** *WDP* profile for  $g^* < 0$  case.

Similarly, the probability that  $\Delta GP[k]$  is lower than zero, given  $\Delta GP[k] = g^*$  and when  $g^* \geq 0$ , is:

$$\begin{aligned} p(\Delta GP[k+1] < 0 | \Delta GP[k] = g^*) &= \\ &= \frac{\Delta GP_{\min}^2}{(\Delta GP_{\max} - \Delta GP_{\min})(g^* - \Delta GP_{\min})}. \end{aligned} \quad (2.53)$$

By means of the conditional probabilities (2.52)–(2.53), it is possible to define the *WDP* (Wrong Decision Probability) Namely, whenever  $\Delta GP$  function changes sign at the instant  $k$ , (*i.e.*  $\Delta GP[k-1] \cdot \Delta GP[k] < 0$ ), the probability to change sign again at time  $k+1$ , (*i.e.*  $\Delta GP[k] \cdot \Delta GP[k+1] < 0$ ) is:

$$WDP = \begin{cases} -\frac{\Delta GP_{\max}^2}{(\Delta GP_{\max} - \Delta GP_{\min})(g^* - \Delta GP_{\max})}, g^* < 0, \\ \frac{\Delta GP_{\min}^2}{(\Delta GP_{\max} - \Delta GP_{\min})(g^* - \Delta GP_{\min})}, g^* > 0. \end{cases} \quad (2.54)$$

Then, to prevent low accuracy in the assessment of  $\Delta GP[k]$  samples, an exponential smoothing of the first order is applied to the sequence  $\Delta GP[k]$ . The trend sequence

$\langle \Delta GP [k] \rangle$  is obtained as,

$$\langle \Delta GP [k] \rangle = \alpha \cdot \Delta GP [k] + (1 - \alpha) \cdot \langle \Delta GP [k - 1] \rangle, \quad (2.55)$$

where  $\langle \Delta GP [k] \rangle$  is used in (2.53)–(2.54) in the place of  $\Delta GP [k]$  as a better assessment of the  $\Delta GP$  dynamics to assess  $WDP$ . The parameter  $\alpha$  is in the range  $[0, 1]$ . On the basis of the  $WDP$  assessment, the proposed reactive VHO algorithm can be so built. Let us introduce the  $WDP$  threshold (*i.e.*  $P_{TH}$ ), defined as the value below which a vertical handover is executed, after a  $\Delta GP$  sign transition. In other words, when the  $WDP$  is estimated lower than a minimum  $P_{TH}$  value, a sign transition in the sequence  $\langle \Delta GP [k] \rangle$ , with  $k = 0, 1, \dots, \infty$ , determines a vertical handover.

Namely, the algorithm proceeds as shown in Figure 2.24, by a Finite State Machine (FSM). The FSM is composed by two states, called as “Network  $i$ ” and “VHO ( $i, j$ ) attempt”, where the MT is connected to Network  $i$ . As the same time, if the MT is connected to Network  $j$ , it will be in states “Network  $j$ ” or “VHO ( $j, i$ ) attempt”.

Whenever a sign transition for sequence  $\langle \Delta GP [k] \rangle$  is detected at time  $k$ , a vertical handover procedure is attempted. The MT will move from “Network  $i$ ” or “Network  $j$ ” to “VHO ( $i, j$ ) attempt” or “VHO ( $j, i$ ) attempt”, respectively. If the estimated  $WDP$  is below the chosen threshold  $P_{TH}$ , the handover is accomplished. So, the MT will move to a stable state (*i.e.* “Network  $i$ ” or “Network  $j$ ”, if the VHO is from network  $j$  to network  $i$ , or viceversa). Otherwise, if  $WDP$  is upper than the chosen threshold  $P_{TH}$ , it will be recomputed every  $\Delta t$  seconds, till either a new change of sign in  $\langle \Delta GP [k] \rangle$  (vertical handover attempt aborted) or  $WDP$  becomes lower than  $P_{TH}$ . The computational complexity of the novel VHO algorithm is  $O(1)$ . Indeed, the core algorithm is implemented by (2.54). The values



of  $\Delta GP_{\max}$  and  $\Delta GP_{\min}$  are required to be known a priori.

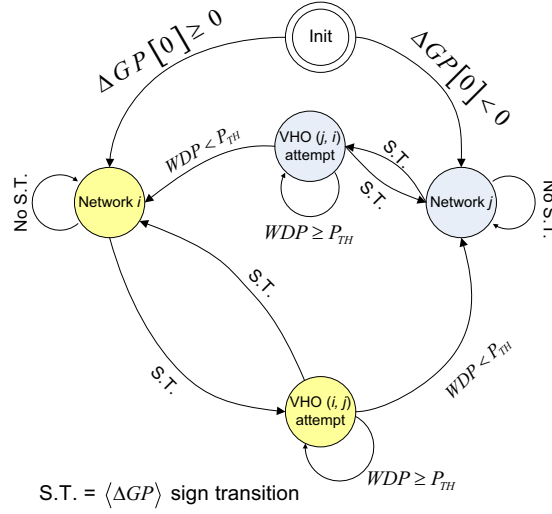

**Figure 2.24:** VHO Algorithm Finite State Machine.

## 2.9.2 Simulation Results

The simulation results have been evaluated in a heterogeneous network environment consisting of two networks with different radio characteristics, such as:

- *Network 1* is a network with a medium transmission range up to 600 m. Network coverage is provided by three access points (APs);
- *Network 2* is a network with a small transmission range up to 120 m. Ten APs are considered in the scenario.

The same capacity is assigned to the two networks in order to evaluate the handover algorithm without one network privileged over the other for its capacity. The MT moves for 2500 steps at man walking velocity with a random mobility pattern. The main pa-

parameters of *Network 1* and *Network 2* are summarized in Table 2.2. The effectiveness of the proposed VHO algorithm is evaluated in terms of two parameters, *i* the cumulative received bits (CRBs), defined as the total number of received bit from step 1 to step 2500 to be maximized, and *ii* the number of vertical handover occurrences to be minimized.

Figure 2.25 and 2.26 show how the CRBs and the number of vertical handovers vary vs. the threshold  $P_{TH}$ , when the simulations are carried out with the considered symmetric network environment, *i.e.*  $\Delta GP_{\max} = \Delta GP_{\min} = 1 \cdot 10^6$ , respectively, as both networks 1 and 2 have the same capacity, as shown in Table 2.2.

In such assumption, the *WDP* defined in (2.54) is compared with  $P_{TH}$  and can never be more than 0.5. Thus,  $P_{TH}$  has to be selected in the range  $[0, 0.5]$ . In order to reduce the impact of MT's random movement and cell location, we collected statistics over 5000 simulated network scenarios and considered the average values for CRBs and number of VHOs. Figure 2.25 shows the average of cumulative received bits (CRBs) [bits], at the end of the MT's walk vs. the threshold  $P_{TH}$ . It is interesting to note that for small values of  $P_{TH}$ , an approach with  $\alpha$  equals to 1 can be used to obtain an high number of received bits, while keeping the number of vertical handovers low. Different values of  $\alpha$  give a loss of received bits for small values of  $P_{TH}$ , because for such values of  $\alpha$  it is not possible to estimate exactly the *WDP* function. If the objective is to maximize the CRBs, the best choice is setting  $P_{TH}$  near to 0.5, and  $\alpha$  in the range  $[0.5, 0.9]$ . As an analogy, in such case the number of vertical handovers grows for high values of  $P_{TH}$ .

Finally, Figure 2.26 depicts the number of vertical handovers that an MT performs during its random walk (*i.e.* called as VHO frequency) vs. the  $P_{TH}$  probability. Different

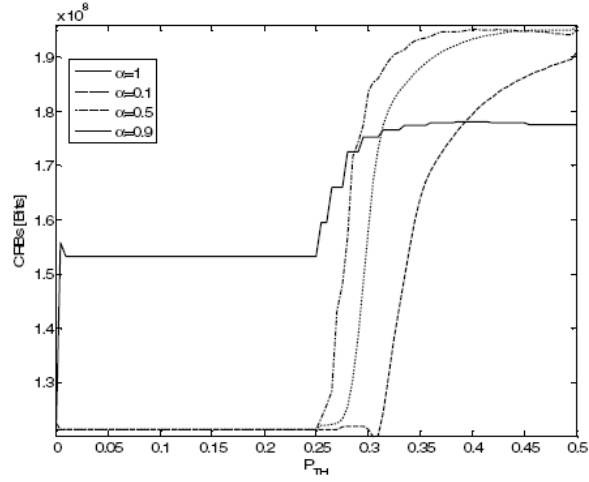

**Figure 2.25:** Cumulative Received Bits vs.  $P_{TH}$ .

values of  $\alpha$  show that the lower the number of vertical handovers is required, the higher  $\alpha$  is to be set.

As a conclusion, the proposed approach can be applied when no knowledge of the probabilistic behavior of the achievable goodput in the two networks is known a priori. The focus is both on maximization of goodput as well as on limitation of vertical handover frequency, which strongly affects mobile terminal performance, in terms of seamless connectivity and consumed energy during a vertical handover.

The function referred to as delta goodput stochastic process is modelled and used in the algorithm to reduce the vertical handover frequency and keep the received bits as high as possible. Through the monitoring of delta goodput stochastic process it is possible to estimate a  $WDP$  function and comparing it with a VHO probability threshold  $P_{TH}$ , in order to limit the vertical handover frequency. In the presented approach a first order exponential smoothing technique is used to assess the delta goodput stochastic process.

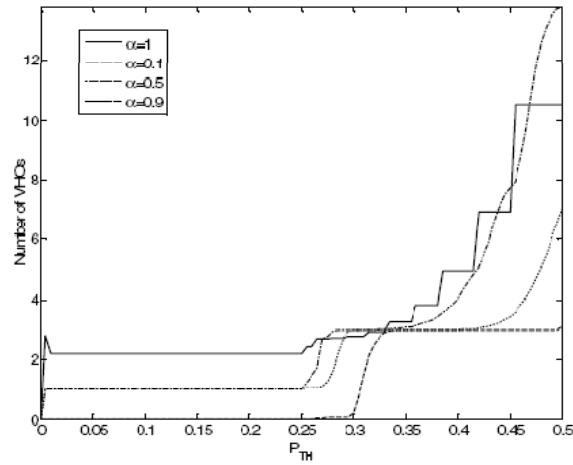

Figure 2.26: Number of vertical handovers vs.  $P_{TH}$ .

## 2.10 Speed-based Vertical Handover

In this Section we address to a Speed-based Vertical Handover algorithm, employed in vehicular environments. Vehicular Ad hoc Networks (VANETs) are emerging as a novel paradigm for new classes of secure and safety services. In Chapter 4 VANETs will be dealt with major details, focusing on a novel communication protocol, and how messages are forwarded in such scenario.

Supporting seamless connectivity remains a challenge in VANETs, due to the high vehicle speed, and the non-homogeneous nature of the network infrastructure nearby. To support seamless connectivity in such heterogeneous environments, vertical handovers between a serving to a candidate network need to be performed.

In this Section we shall present an analytical model in support of a novel vertical handover algorithm that uses the vehicle's speed as crucial input and overcomes, under our assumptions, network performance of recent related works. Moreover, we support our

initial results with a simulation study.

### 2.10.1 Vertical Handover in Vehicular Environment

Seamless connectivity in Vehicular Ad hoc NETWORKS (VANETs) is a challenge. Future vehicles, endowed with sophisticated *on-board* equipment, shall be able to communicate with each other, and with the neighboring wireless network infrastructure by means of several network interface cards, *i.e.*, IEEE 802.11p, WiMAX, UMTS, GPS, etc [36].

Both the paradigms that provide connectivity in VANET, Vehicle-to-Vehicle (V2V) and Vehicle-to-Infrastructure (V2I), present connectivity problems: different speed and traffic densities result in low vehicular contact rate, and so limit communications via V2V protocols, while V2I communications are limited, especially in highway scenarios, by the low number of Road Side Units (RSUs) displaced on the roads [37, 38].

The problem of a seamless connectivity becomes even more challenging as vehicles move across overlapping heterogeneous wireless cells environments. In such scenarios, frequent and not always necessary switches from a Serving Network (SN) to a Candidate Network (CN) may occur, often degrading network performance.

The switching mechanism from a SN to a CN can be driven by the vehicle or by the infrastructure, and is executed according to a well defined decision criteria; examples of such criteria are: the type of RSU technology, the received signal power, quality-of-service metrics, and so forth [28, 39].

We now present a vehicle-controlled VHO decision method based on the vehicle speed. The proposed technique, that we call *Speed-based VHO (S-VHO)*, aims to both minimize VHO frequency—the number of VHO occurrences—and maximize the throughput mea-

sured at the vehicle.

The proposed approach does not consider any signal strength parameters; such information in fact may be out of date, unreliable and its variance may fluctuate significantly, especially in VANET scenarios, causing unnecessary vertical handovers, and throughput degradation. In particular, our S-VHO algorithm bases its decision on the estimation of the “cell crossing time”, that is, the time spent in crossing a wireless cell by the vehicle.

After presenting the state-of-the-art about handover in VANETs, we shall show analytically in Subsection 2.10.2, the details of how these information are used, while in Subsection 2.10.3 we discuss the algorithm in details. In Subsection 2.10.4 we show the effectiveness of our approach with a simulation setting scenario. In particular, we show benefits in terms of both network performance, and limitation of number of vertical handover occurrences. We also compare our approach with the recent speed based approach described in [40].

The most relevant work, that we also used as comparison terms in our performance analysis, is the vertical handover approach for VANETs proposed by Yan *et al.* in [40]. The authors discuss a vertical handover algorithm based on the prediction of the traveling distance of a vehicle within a wireless cell. Their main result consists on minimizing the probability of unnecessary handovers. Such probability is constructed, among other details, by considering a speed ratio. The ratio is between the instantaneous speed of a vehicle, and a value,  $V_{max}$  (maximum speed), function of the technologies radius cell coverage, and of the average handover latency.

We also use speed as input to our algorithm, but our S-VHO technique uses deterministic

metrics, and a connectivity link switching decision based on a throughput estimation, as opposed to probability estimations. Moreover, in their valuable work, network performance are unfortunately not shown.

Other recent works deal with VHO decisions in VANETs, as a solution to V2V limitations. Some of those algorithms for VHO decisions are based on physical parameters (like the received signal strength, and the handover latency).

In [41], for example, the authors have looked at how to reduce the loss of throughput in vehicular networks. Their valid ideas are limited to horizontal handovers in WLAN networks though, and so to homogeneous scenarios. Other approaches to limit vertical handover drawbacks have been analyzed; among all, we cite the work of Chen *et al.* [42] in which a novel network mobility protocol for vehicular ad hoc networks is presented, aiming to a reduction of both handoff latency and packet loss rate. Olivera *et al.* [43] instead, propose the Always Best Connected paradigm for vertical handovers in VANETs. This mechanism operates at the network layer, and achieves a seamless connectivity between WLAN and UMTS networks.

Moreover, in [44], Guo *et al.* propose a fast handover technique, focusing on handovers between WiMAX and Wi-Fi technologies, and using an IP layer handover approach. In contrast, our method focuses on VHO mechanism between UMTS and Wi-Fi networks, and it is a Vehicle-Controlled VHO approach, through smart *on-board* equipment.

### 2.10.2 Analytical Model

We present an analytical framework, by depicting first how throughput in both serving and candidate networks can be estimated, (paragraph 2.10.2), and then we show analytically

how a vertical handover decision is taken by the vehicle (paragraph 2.10.2).

We assume that vehicles are driving at constant speed  $v$  [m/s], and following a Manhattan mobility model.  $v$  is the vehicle speed vector whose direction is indicated with an arrow in Figure 2.27. The vehicle's location is continuously updated and tracked by means of a Global Positioning System (GPS) receiver.

### Throughput Estimation

If we denote as  $t_{\text{in}}$  the time instant when a considered vehicle enters in a wireless cell (*i.e.* an UMTS network), we can determine the time instant of the vehicle exiting the wireless cell as:

$$t_{\text{out}} = t_{\text{in}} + \frac{\Delta x}{|v|}, \quad (2.56)$$

where  $\Delta x$  is the distance covered inside the wireless cell during the time interval  $t_{\text{out}} - t_{\text{in}}$ . Using classic Euclidean geometry, we can further expand the term  $\Delta x$ . Denoting  $R$  as the radius of the wireless cell, and  $\phi$  as the angle between the vehicle's line of sight with the RSU and the direction of the vehicle, we have:

$$\Delta x = 2R \cos \phi. \quad (2.57)$$

Moreover, denoting the coordinates of the cell entrance and exit points as  $P_{\text{in}} = (x_{\text{in}}, y_{\text{in}})$ , and  $P_{\text{out}} = (x_{\text{out}}, y_{\text{out}})$  respectively, we compute the angle  $\phi$  as

$$\phi = \arctan \left( \frac{y_{\text{out}} - y_{\text{in}}}{x_{\text{out}} - x_{\text{in}}} \right). \quad (2.58)$$



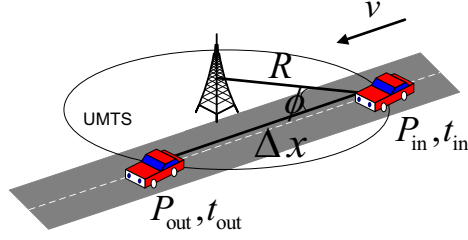

**Figure 2.27:** A vehicle moves at constant speed  $v$  and follows a Manhattan mobility model. Euclidean geometry is used in combination with the GPS system to compute the *cell crossing time*.

Given all the above, we are ready to express the estimated exit time from the wireless network as combination of well-known terms; in particular:

$$t_{out} = t_{in} + \frac{2R \cdot \cos \left[ \arctan \left( \frac{y_{out} - y_{in}}{x_{out} - x_{in}} \right) \right]}{|v|}. \quad (2.59)$$

Let us now consider the instant of time  $t_{in}$ , as the time in which a vehicle is connected to a SN. If we assume negligible the signaling time to establish the connection, the time interval that the vehicle spends under the same wireless network is:

$$\Delta T = t_{out} - t_{in}. \quad (2.60)$$

Then, by definition of throughput  $\Theta(t)$  [Bits] evaluated for  $t = \Delta T$  [s], we have:

$$\Theta(\Delta T) = B_{SN} \cdot \Delta T, \quad (2.61)$$

where  $B_{SN}$  [Bit/s] is the bandwidth of the service network. Furthermore, by definition of the vector velocity  $v$  [m/s], and by (2.59) we have:

$$\Delta T = \frac{\Delta x}{|v|} = \frac{2R \cos \phi}{|v|}, \quad (2.62)$$

and so (2.61) becomes:

$$\Theta(\Delta T) = \frac{2R \cos \phi \cdot B_{SN}}{|v|}. \quad (2.63)$$

This last equation relates the throughput  $\Theta$  experienced at the vehicle receiver, with the speed of the vehicle itself, and the time spent by the vehicle in the cell; Equation (2.63) is the first important fundament of our speed-based vertical handover algorithm.

### Handover Decision

We now show how the throughput information is used for a handover decision. Consider a vehicle connected to a SN, entering in a CN. We denote as  $L$  [s] the handover latency, and as  $B_{\text{CN}}$  [bit/s] the candidate network bandwidth. We also introduce a parameter  $\delta$ , that we call *hysteresis factor*, and that represents a positive constant introduced to make sure handovers do not occur when the two competitive networks have negligible bandwidth difference.

Since our aim is to maximize throughput, system initiates a handover from the SN to the CN, if:

$$\Theta_{\text{CN}} \geq \Theta_{\text{SN}}. \quad (2.64)$$

Since the throughput is expressed as the product of bandwidth and time interval, we have that:

$$(B_{\text{CN}} + \delta)(\Delta T - L) \geq B_{\text{SN}}\Delta T, \quad (2.65)$$

from which:

$$B_{\text{CN}} \geq \frac{B_{\text{SN}} + \delta \left(1 - \frac{L}{\Delta T}\right)}{1 - \frac{L}{\Delta T}}. \quad (2.66)$$

As we notice from (2.59), this last inequality indirectly depends on the vehicle's speed  $v$ , as the time  $\Delta T$  does. Therefore the vehicle decides whether to proceed with a handover or not, based on its current speed  $v$ .

Inequality (2.66) is the main contribution we have get; it tells us that a vertical handover might not be necessary, even though a vehicular traverses a wireless network with a high instantaneous bandwidth, because the handover latency and the vehicle speed play together a crucial role in the VHO decision.

### 2.10.3 Speed-Based Vertical Handover

In this Section we illustrate the steps of our speed-based vertical handover algorithm in details.

Let us consider Figure 2.28. The main steps of the S-VHO algorithm are represented in a flow chart. We identify three main steps: (i) data rate estimation, (ii) crossing time estimation, and (iii) handover decision. The inputs of the algorithm are the vehicle speed  $v$ , the time stamp  $t_{in}$  of ingress of the vehicle into a wireless cell, and the GPS location information  $P_{in}$ .

**Data rate estimation:** As a vehicle enters in an area covered by at least two heterogeneous wireless cells, the data rate from a candidate network is compared with the current rate of the serving network.

**Crossing time estimation:** If the new rate overcomes the old of at least a value equal to the hysteresis threshold, the crossing time is computed as shown in (2.62), to evaluate whether it makes sense to proceed with an handover. The value of the threshold  $T_{VHO}$ , obtained from (2.65) is:

$$T_{VHO} = \frac{2R \cos \phi B_{CN} L}{\Delta S [B_{CN} - (B_{SN} + \delta)]}. \quad (2.67)$$

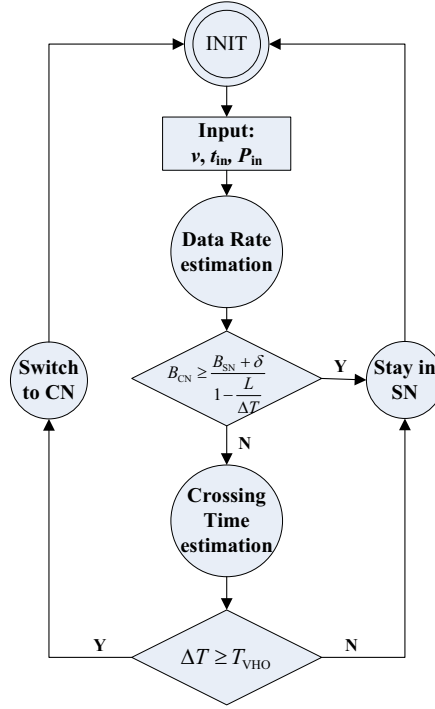

**Figure 2.28:** Speed Vertical Handover (S-VHO) algorithm.

**VHO decision:** The crossing time estimation allows a throughput evaluation that eventually triggers an handover decision if there exist a throughput gain. From Equation (2.67) follows in fact that a VHO occurs if the *crossing time* is higher or equal than  $T_{VHO}$  ( $\Delta T \geq T_{VHO}$ .) When entering the initialization phase, the algorithm enters a stand-by mode for  $T_w$  (waiting time) seconds. This holding time should vary from the scenario and its role is better described in Section 2.10.4.

#### 2.10.4 Simulation Results

In this Section we show an initial performance analysis simulation study for our proposed S-VHO algorithm. We compare, with respect to both number of vertical handovers, and

network performance, our approach with a recent speed-based algorithm proposed by Yan *et al* in [40]. We refer to the related work as Speed-Probability Driven (SPD) algorithm. Our proposed method, under our assumptions, improves the network throughput and minimizes the number of vertical handovers.

A vehicular environment scenario composed by several WLAN and UMTS cells for the wireless network infrastructure has been set up with our own event driven simulator. The wireless network infrastructure has been set up with our own event driven simulator. The vehicle paths, follow a Manhattan mobility model over a grid of  $400 \times 400$  square zones; each edge of a square as a length of five meters. The heterogeneous network environment has been setup like in [1, 2, 3]. Figure 2.29 depicts our simulated scenarios with several vehicles moving at different speeds.

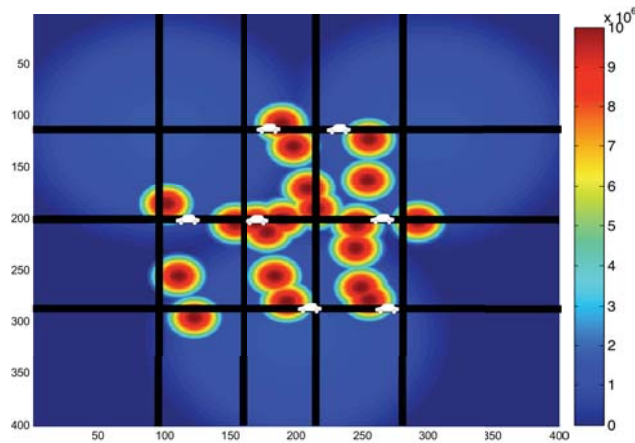

**Figure 2.29:** Vertical handover simulated scenario for vehicular environment.

The average vertical handover latencies from UMTS to WLAN, and from WLAN to UMTS, have been considered respectively equal to  $L_{U \rightarrow W} = 2$  s, and  $L_{W \rightarrow U} = 3$  s [40], and the data rate of UMTS and WLAN were set to 384 kbit/s, and 11 Mbit/s, respectively.

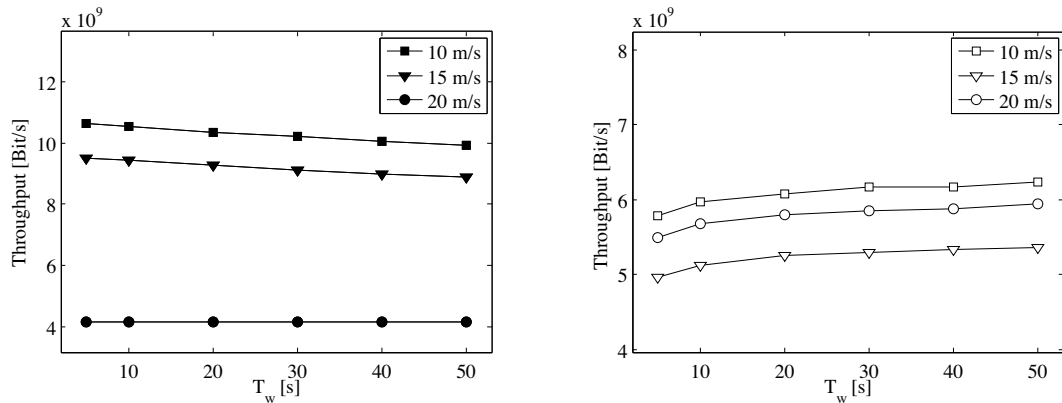

**Figure 2.30:** Cumulative Received Bits evaluated for different values of vehicle's speed. (*Left*) Proposed S-VHO algorithm (dark markers), and (*Right*) the related work SPD (white markers).

Finally, an ITU Vehicular model has been considered for the channel [45].

In order to evaluate different mobility cases, different speed values have been tested; in particular, the speed simulation range has been increased from 10 m/s up to 35 m/s, capturing urban environment as well as highway scenarios.

The simulation results are obtained averaging 100 heterogeneous network scenarios, each composed by 3 UMTS base stations (BSs) and 30 WLAN access points (APs). In our simulator, the location of each cell is randomly generated, and a vehicle moves in this area with the constant speed.

### Throughput and Number of Handovers

In Figure 2.30 we report the proposed S-VHO, as well as the SPD algorithm performance. We first plot the average Cumulative Received Bits (CRBs) [Bits], versus the *waiting time* parameter. The *waiting time* represents the time after which, after a VHO occurrence,

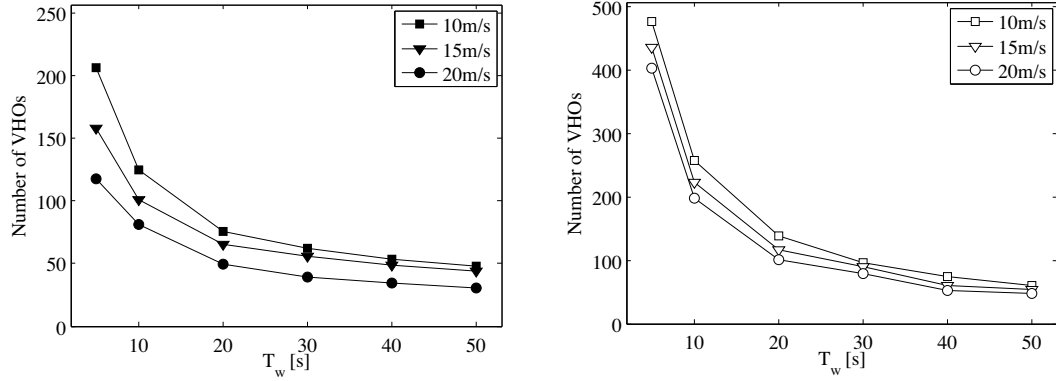

**Figure 2.31:** Number of Vertical Handovers for different values of vehicle’s speed. (*Left*) Proposed S-VHO algorithm (dark markers), and (*Right*) the related work SPD (white markers). Notice the scale difference.

the algorithm enters in a stand-by mode. This time is introduced to avoid unnecessary handovers hence limiting the *ping-pong* effect [1]. The CRBs represent the amount of received bits by a vehicle moving inside an heterogeneous wireless environment for the simulated period of time.

We notice how the throughput performance of our S-VHO outperforms at every speed the SPD algorithm proposed in [40]. Our performance improvement are justified by the absence of received signal strength dependance in our handover assessment criteria.

In Figure 2.30 (*left*), we notice how the CRBs in our S-VHO algorithm decreases as the vehicle’s speed increases. In contrast, the SPD algorithm has a smoother trend (Figure 2.30 (*right*)). We believe this is because the stochastic approach is less responsive to speed variations.

The SPD algorithm shows best performance when the waiting time parameter increases.

This behavior is different from the S-VHO. In fact, the waiting time limits the number of VHOs, and therefore introduces performance losses. Again, the SPD trend is justified through the probability of performing a VHO. In contrast, our S-VHO has good performance for low values of *waiting time*, by maintaining lower VHO frequency.

Figure 2.31 reveals the number of vertical handovers executed by the vehicle during a simulation, for both S-VHO (*left*) and SPD (*right*) algorithms. As we notice, our S-VHO approach result in a lower number of VHOs. In estimating the crossing time as opposed to rely on Received Signal Strength measurement we ended up in improving network performances by reducing the number of handovers.

### 2.10.5 Conclusions

In this Section we have attacked the problem of providing seamless connectivity in vehicular ad hoc networks, and we have proposed a new vertical handover algorithm that makes use of the speed of the vehicle as a switching assessment criteria. We have supported our solution with an analytical framework and we showed initial performance analysis results on throughput and on number of handovers. Moreover, we have compared our approach with another recently proposed speed-based vertical handover algorithm [40] using our own event driven simulator.

We have showed that under our assumptions of constant speed and Manhattan mobility model, S-VHO overcomes the related work algorithm. In particular, we ensure both smaller number of vertical handovers, and a greater throughput.

We are currently working on extending our model to prove bounds on the vehicle speed and we plan to use our result for the design of a new video streaming protocol for real



time VANET application, as gaming and video on demand [46]. We also plan to show performance results in a wider range of the parameter space.