



**FREE SPACE OPTICAL NETWORKING
WITH VISIBLE LIGHT:
A MULTI-HOP MULTI-ACCESS SOLUTION**

ZEYU WU

Dissertation submitted in partial fulfillment
of the requirements for the degree of
Doctor of Philosophy

**BOSTON
UNIVERSITY**

BOSTON UNIVERSITY
COLLEGE OF ENGINEERING

Dissertation

**FREE SPACE OPTICAL NETWORKING
WITH VISIBLE LIGHT:
A MULTI-HOP MULTI-ACCESS SOLUTION**

by

ZEYU WU

B.S., Huazhong University of Science and Technology, 2003
M.S., University of New Orleans, 2006

Submitted in partial fulfillment of the
requirements for the degree of
Doctor of Philosophy

2012

Approved by

First Reader

Thomas D.C. Little, PhD
Professor of Electrical and Computer Engineering

Second Reader

Jeffrey Carruthers, PhD
Associate Professor of Electrical and Computer Engineering

Third Reader

Murat Alanyali, PhD
Associate Professor of Electrical and Computer Engineering

Fourth Reader

Mona Mostafa Hella, PhD
Associate Professor of Electrical, Computer and Systems Engineering, Rensselaer Polytechnic Institute

*Nothing in life is to be feared, it is only to be understood.
Now is the time to understand more,
so that we may fear less.*

Marie Curie

Acknowledgments

I would like to thank my advisor, Professor Thomas Little, for introducing me into Visible Light Communication, a frontier wireless technology. I am very grateful to him about giving me opportunities to explore the challenges and guiding me carving out my research topics. I want to thank him for the moral and financial support and the confidence bestowed in me.

I also want to thank Professor Jeffrey Carruthers. His broad knowledge and experience on wireless optical communication provide me with great helps throughout my research. This brings me to thank Professor Murat Alanyali and Professor Mona Mostafa Hella for spending their precious time on helping me with my dissertation.

Then, I would like to thank all my old and new friends for the love and support during these five years' life in the beautiful Boston. Especially Jimmy Chau, Michael Rahaim and Tarik Borogovac who share their knowledge and wisdom on my research.

My final gratitude goes to my family. There is no words in the world could fully express my appreciation for the love and support from my mom and dad. I love you.

This work was supported primarily by the Engineering Research Centers Program of the National Science Foundation under NSF Cooperative Agreement No. EEC-0812056.

FREE SPACE OPTICAL NETWORKING
WITH VISIBLE LIGHT:
A MULTI-HOP MULTI-ACCESS SOLUTION

(Order No.)

ZEYU WU

Boston University, College of Engineering, 2012

Major Professor: Thomas Little, PhD,
Professor of Electrical and Computer Engineering

ABSTRACT

Wireless communication is currently dominated by Radio Frequency (RF) technologies. However, constraints, such as limited bandwidth and electromagnetic interference, limit applications of RF technologies in certain scenarios. For example, RF signals can cause interference with aircraft communication or medical devices in airports or hospitals. Meanwhile, recent developments in solid-state Light-Emitting Diode (LED) materials and devices are driving a resurgence into the use of Free-Space Optical (FSO) wireless communication. Many opportunities exist to exploit low-cost nature of LEDs and lighting units for widespread deployment of optical communication. However, some characteristics of the optical medium, including directionality and susceptibility to visible light noise sources, must be managed.

In this dissertation, a model for indoor Visible Light Communication (VLC) applications is provided to analyze and predict the signal attenuation, Signal-to-Noise Ratio (SNR), Bit Error Rate (BER) and data rate. Discrete Multi-tone (DMT)

modulation is discussed for optical signaling and analysis shows that although DMT requires good SNR, it can provide 4 to 5 times the channel capacity of simple modulation schemes such as On-Off Keying (OOK). We propose an original solution for indoor applications that achieves continuous 10 Mb/s data rates while supporting multiple access under Non Line-of-Sight (LOS) condition. Analysis and simulation of the two protocols under the hexagonal transceiver configuration indicate suitability for high data rate communications between peers or multiple devices using the peer-to-host mode. Furthermore, a novel Medium Access Control (MAC) scheme is proposed in order to solve the contention among mobile receivers due to signal directionality, provide continuous connectivity and meet the expectation of low complexity and low cost. Performance analysis shows more than 50 % improvement on latency at the expense of a 6 % drop on system throughput.

Contents

1	Introduction	1
1.1	A Brief History	1
1.2	Characteristics Comparison	2
1.2.1	Advantages of FSO	2
1.2.2	Visible Light FSO	3
1.2.3	Limitations and Problems	5
1.3	Dissertation Outline	7
1.3.1	Contributions	7
1.3.2	Organization	9
2	Wireless Optical Communications	11
2.1	Background	11
2.1.1	Regulations and Standards	11
2.1.2	Link Topologies	14
2.1.3	Modulation Schemes	21
2.1.4	Channel Model	23
2.1.5	Multi-Input Multi-Output	27
2.1.6	Direct Sequence Spread Spectrum	29
2.2	Related Works	30
2.2.1	Prototypes	31
2.2.2	Other Research Groups	40

3	Modeling and Signaling of Indoor VLC	43
3.1	Framework for Indoor Scenarios	43
3.1.1	Room Geometry	43
3.1.2	Optical Power Analysis of LED Transmitter	45
3.1.3	LED and Photodiode Parameters	47
3.2	Channel Signal Attenuation Model	48
3.2.1	Signal Attenuation	48
3.2.2	SNR	50
3.2.3	Upper Bound of the Rate	50
3.2.4	BER	51
3.2.5	Performance Analysis	51
3.2.6	New VLC Prototype	53
3.3	DMT Analysis	54
3.3.1	BER	57
3.3.2	Channel Capacity	61
3.4	Summary	67
4	Multi-hop Multi-access VLC Solution	68
4.1	Networking Protocols for Blocking of Service Challenge	69
4.1.1	System Model	69
4.1.2	Networking Protocols	73
4.1.3	Connectivity and Rate Performance Analysis	80
4.2	Centralized Optical MAC Scheme	88
4.2.1	Problem Definition	89
4.2.2	Existing MAC Solutions	91
4.2.3	Proposed COMAC Scheme	97
4.2.4	Performance Analysis of MAC Schemes	103

4.3 Summary	109
5 Conclusion	111
5.1 Summary	111
5.2 Future Work	113
References	115
Curriculum Vitae	125

List of Figures

1·1	Evolution of wireless optical communications [Smo] [Nav] [Inf]	1
2·1	Classification of simple links according to the degree of directionality of the transmitter and receiver and whether the link relies upon the existence of a LOS path between them [KB97]	16
2·2	Point-to-Point link model	17
2·3	Diffuse link model	18
2·4	Quasi-Diffuse link model	19
2·5	Basis function (a) and Constellation of Symbols (b) for (1)OOK, (2)4-PPM, (3)PAM and (4)QAM	22
2·6	Communication system model for optical intensity channel	23
2·7	(a) Dominant input-referred noise power spectral densities (b) Dominant input-referred noise variances [KB97]	27
2·8	(a) Pixelated system [HK06] (b) MSD system [AKJ04]	28
2·9	Direct Sequence Spread Spectrum [FK03]	29
2·10	Short range (<10 m) VLC Prototypes with Visible Light Medium [GRLW08a] [VKN ⁺ 09b] [VKN ⁺ 09a] [VFK ⁺ 10] [VKN ⁺ 10b] [VKN ⁺ 10a] [MOF ⁺ 09] [MOF ⁺ 08b] [ATO10] [BPW ⁺ 10] [ASWH09] [YCZ ⁺ 09] . . .	31
2·11	Schematic of OMEGA project [LGB ⁺ 08]	33
2·12	Prototypes from FIT [VFK ⁺ 10] [BPW ⁺ 10]	34
2·13	Prototypes from University of Oxford [ATO10] [MOF10]	36
2·14	Prototypes from Nagoya University [IPE ⁺ 08]	37

2-15	Prototypes from Keio University [MHK08] [KHNS07]	38
2-16	Prototypes from Boston University [LDS ⁺ 08] [WCL11]	39
3-1	An illustration of VLC system	44
3-2	Proposed FSO system model for indoor applications	45
3-3	Radiation spectrum of LXML-PWC1-0040 [LED]	46
3-4	LOS diffuse link model for signal attenuation [RX09]	48
3-5	Signal Attenuation (a), SNR (b), Max Rate (c) and BER (d) of the prototype system without blue filtering	52
3-6	Signal Attenuation (a), SNR (b), Max Rate (c) and BER (d) of the prototype system with blue filtering	54
3-7	Current VLC prototype for indoor applications [WCL11]	55
3-8	Waveforms of transmit and receive signals [WCL11]	56
3-9	Orthogonal Frequency Division Multiplexing [FK03]	57
3-10	(a) Encoded signal after QAM (b) Modulated signal after IFFT (c) DC- offset signal before transmitting (d) Received signal after FFT recovery	58
3-11	BER performance among different modulation schemes	60
3-12	Channel capacities for four different cases under unit average power constraint	66
4-1	Transmission architecture and interference by using honeycombed sphere user device	71
4-2	Desktop level user device	72
4-3	Peer-to-Peer protocol illustration	76
4-4	Peer-to-Host protocol illustration (cluster heads are marked with red)	79
4-5	Reconnectivity success ratio of p2p, p2h and hybrid protocols	82
4-6	Collision rates	85

4.7	Normalized throughput of system	86
4.8	Average throughput of user	87
4.9	Illustration of MAC scenario	89
4.10	Illustration of mobile nodes collision in indoor FSO systems	90
4.11	The superframe structure of Inter-MAC [OME]	94
4.12	An example of the superframe structure [oEG11]	96
4.13	An example of one cycle and IFS in it	98
4.14	New user device's access flow chart	100
4.15	Existing user device's access flow chart	101
4.16	Latency comparison with rate of (1) 1 Mb/s and (2) 10 Mb/s for CSMA/CA, COMAC and 802.15.7 standard	106
4.17	Normalized throughput with rate of (1) 1 Mb/s and (2) 10 Mb/s for CSMA/CA, COMAC and 802.15.7 standard (fully loaded network)	107
4.18	Normalized throughput with rate of (1) 1 Mb/s and (2) 10 Mb/s for CSMA/CA, COMAC and 802.15.7 standard (partial loaded network)	108
5.1	Software structure diagram	114

List of Abbreviations

AIr	Advanced Infrared
ANSI	American National Standards Institute
AoA	Angle of Arrival
APD	Avalanche Photodiode
AWGN	Additive White Gaussian Noise
BER	Bit Error Rate
CAP	Contention Access Period
CCD	Charge-Coupled Device
CFP	Contention Free Period
CMOS	Complementary Metal-Oxide-Semiconductor
COMAC	Centralized Optical MAC
CRP	Contention Request Period
CS	Carrier Sensing
CSK	Color Shift Keying
CSMA/CA	Carrier Sense Multiple Access with Collision Avoidance
CTS	Clear to Send
dB	Decibel
DC	Direct Current
DMT	Discrete Multi-tone
DS-CDMA	Direct Sequence Code Division Multiple Access
DSSS	Direct-Sequence Spread Spectrum
DTP	Data Transmission Period
DVCS	Directional Virtual Carrier Sensing
EU	European Union
FIR	Finite Impulse Response
FIT	Fraunhofer Institute of Telecommunications
fps	Frame per Second
FOV	Field of View
FSO	Free-Space Optical
GTS	Guaranteed Time Slot
HD	High-Definition
HtoH	Host-to-Host

ICSA	Infrared Communication Systems Association
IEC	International Electrotechnical Commission
IEEE	Institute of Electrical and Electronics Engineers
IFFT	Inverse Fast Fourier Transform
IFS	Inter-frame Spacing
IM/DD	Intensity Modulation/Direct Detection
IR	Infrared
IrDA	Infrared Data Association
ISI	Intersymbol Interference
ISM	Industrial, Scientific and Medical
JEITA	Japan Electronics and Information Technology Industries Association
LD	Laser Diode
LED	Light-Emitting Diode
LOS	Line-of-Sight
MAC	Medium Access Control
MAI	Multi Access Interference
MCL	Multimedia Communication Lab
MIMO	Multi-Input Multi-Output
MSD	Multi-Spot Diffusing
MSM	Multiple-Subcarrier Modulation
NDP	Neighbor Discovery Packet
NRZ	Non-Return-Zero
OFDM	Orthogonal Frequency-Division Multiplexing
OOC	Optical Orthogonal Codes
OOK	On-Off Keying
PAM	Pulse Amplitude Modulation
pdf	Probability Density Function
PN	Pseudo-Noise
PPM	Pulse Position Modulation
PSD	Power Spectral Density
QAM	Quadrature amplitude modulation
RF	Radio Frequency
RRDP	Reactive Route Discover Packet
RTS	Request to Send
RZ	Return-to-Zero
SDR	Soft Define Radio
SINR	Signal-to-Interference-plus-Noise Ratio
SNR	Signal-to-Noise Ratio
SRP	Slotted Request Period
StoH	Source-to-Host
TTL	Time to Live

UV	Ultra-Violet
VLC	Visible Light Communication
VLCC	Visible-Light Communication Consortium
VPPM	Variable Pulse Position Modulation
WLAN	Wireless Local Area Network

Chapter 1

Introduction

1.1 A Brief History

RF communication is an incumbent and evolving technology that has high utility and will be the major method for wireless communication for the indefinite future. However, RF suffers from several constraints that people are not satisfied with its performance in some certain scenarios, such as hospitals, tunnels and subways [Hos11]. For next generation of wireless communication technologies, with the development of new Laser Diodes (LD) and LED materials, researchers [Bou05] believe that FSO presents a viable and promising supplemental technology to the RF system by enabling the use for short range indoor applications in addition to previous outdoor long range cases. It uses light beams propagated through the air or space to carry information.



Figure 1.1: Evolution of wireless optical communications [Smo] [Nav] [Inf]

This kind of usage can be traced back to ancient time when people used signal fire as the warning of invasion. Modern FSO is an offshoot of the development of laser technologies in the 1960s which is driven by the military purposes. Later the emerging

of small infrared (IR) LD and LED makes IR applications continue to predominate for niche applications (e.g., TV remote controls). Nowadays, due to the development of new LED materials and devices, replacing old incandescent and fluorescent lights with LED lights is undoubted in the future [MN99]. Such small and power efficient devices give rise to more interesting wireless communication applications for both indoor and outdoor scenarios as a medium for modulated FSO communications. Researchers are attracted by such newly developed and more promising methods of using visible light because of the low-cost and volume production of LED devices for lighting [KB97, Car03, Qaz06, Arn03, Bou05, Hra04].

1.2 Characteristics Comparison

The optical signal is quite different from the wireless signal from RF. And it is these differences that make the applications and scenarios vary. We start from the comparison of RF and general optical signal first.

1.2.1 Advantages of FSO

Design Complexity

Instead of relatively large device with sophisticated circuits, wireless optical communication only requires very small and cheap LED and photon detector as transceivers and easier of installation [THN00]. In some applications, only with a simple modulation scheme like Pulse Position Modulation (PPM) we can achieve high speed transmission [TN97]. Moreover, there is no need to coordinate devices belonging to different rooms due to opacity, and the short carrier wavelength and large area, square law photon detector lead to efficient spatial diversity that prevents multipath fading [KB97].

Bandwidth

For RF, one must have a license for operating at certain band. Even if in the Industrial, Scientific and Medical (ISM) radio bands, your available bandwidth is limited. For example, the most common 2.4 GHz ISM band for IEEE 802.11 b and g only provides 20 MHz bandwidth [oEG07]. On the other hand, the optical spectral region offers a virtually unlimited bandwidth (300 THz) that is unregulated worldwide. The huge frequency band from IR to visible light which beyond the 3K - 300G Hz radio spectrum is all available for being used as optical signal without any license fee. Also, due to the rapid development of optical material and the potential huge bandwidth, FSO communication is possible to achieve rates of Gb/s.

Security

Different from RF, wireless optical signal cannot penetrate through walls (but it can still penetrate through windows) so that communication is confined to the room in which it originates. This confinement makes it easy to secure transmissions against casual eavesdropping, and it prevents interference between links operating in different rooms.

1.2.2 Visible Light FSO

Another very interesting area which only emerged in recent years is wireless optical communication with visible light LED. Some Japanese pioneers started their research on it from 1999. Due to the high brightness LED with new material, Gallium Nitride, we are possible to substitute current incandescent and fluorescent light devices with low power consumption and more efficient devices which can also achieve the ability of wireless communication. From [Kav07], [THN00], [PKLC02] and [AK06], comparing to IR, such devices are capable to partly overcome the shadowing problem of IR case

because LED light fixtures are distributed throughout the room and visible light is more able to be reflected due to its larger refractive index than IR. Also, by combining both communication and illumination together within one device, we can potentially reduce the cost and spatial requirement on additional communication devices. We have investigated the state-of-the-art works and will introduce them in Section 2.2. Based on these publications, we compare results of RF communication and VLC in Table 1.1.

Attribute	RF@2.4GHz	VLC	Advantage
Security/Privacy	Penetrates walls	Does not penetrate walls, prevents snooping	VLC
Available Bandwidth Capacity	Signals sent at same frequency can interfere with one another and thus, limited by contention; signals degrade from peak BW.	Light can be directed smart light sources can be tuned to adapt to different environments and narrow footprints	VLC
Cost of Additional Bandwidth Spectrum	Very high when available	None (yet)	VLC
Interference	Self, other users on same frequency slows transmission speed, ISM sources	Visible natural (sun) and man made light (non-LED lamps) slow transmission speed	Varies
Multipath fading	Destructive interference: RF waves bounce off conductive surfaces and arrive at different times and/or are out of phase	Interference appears as noise. No signal cancelling.	VLC
Transmission Speed	150 Megabits per second deployed	Comparable, but with reuse of volume for higher aggregate speed.	VLC
Estimated Comparative Cost	<\$ 20	<\$ 2(Based on IrDA)	VLC

Table 1.1: Comparison between RF communication and VLC techniques

1.2.3 Limitations and Problems

As every new technology, we see that currently visible light communication is still in the early stage that there are many severe problems or limitations needed to be solved.

LOS

As discussed as a security issue, optical signals cannot penetrate most of objects in our daily life. This characteristic can be also considered as a disadvantage that preventing signal from spreading among multiple rooms. And furthermore, reflection can absorb much energy so that the rate of communication without LOS between transceivers is greatly limited or even prohibited. There is no any optical diffuse signal under power regulation can be strong enough to let reflected signals still preserve enough power for communication. Therefore, we are trying to solve this challenge from another way which will be presented later.

Multipath Distortion

When the transceivers are equipped with wide beam, the copies of same signal from different paths arrive the destination with different amount of relay, because each path has different length from source to destination. This creates a problem called multipath distortion which can cause Intersymbol Interference (ISI) that severely degrades the performance.

Signal Attenuation

This problem is also associated with wide transmission beam. In visible light FSO, this becomes more critical since the ambient light could be very strong that the resulting SNR is low. Also, when encountering high signal attenuation, the cost will be increased by equipping a receiver good enough for distinguishing such low signal.

Mobility

No matter what kind of link model is adapted, the wireless optical signals are normally not omni-directional except certain device geometry design [YAKD09]. The receiver must be within the range of the transmitter. This makes the FSO almost immobile or mobile with a complex tracking module. Furthermore, when losing the signal, realignment could be a complicated challenge.

In Table 1.2, we list the possible solutions for some critical problems of visible light FSO, and we will also explore the feasibility of putting them together. The reasons and challenges are discussed in detail later in this dissertation.

Problem	Solution	Note
Modulation Bandwidth	Equalization	Even a simple first-order receiver equalizer can improve the channel response substantially [ZOM ⁺ 08]
	Blue Filtering	It can increase the bandwidth substantially, albeit at the penalty of reduction in received power due to filter losses [GLL ⁺ 07]
LOS Re- quirement	Mesh Networking	Node bypasses the object by relaying from neighbor(routing method is required)
Multipath Distortion	DMT	It is robust against ISI caused by multipath distortion (ISI will be a major issue for diffuse link when rate is high [PL09])
Multiple Access	CSMA/CA	It has simple implementation with a small chance of collision
	DSSS	It enables sharing the channel simultaneously while enhancing SNR(processing gain)
Reliability	MIMO	Each face is an array that can enhancing reliability by diversity coding
Signal At- tenuation	Device Geometry	The space is divided by several faces that beams and Field of View (FOV) could be much narrower
Mobility	Device Geometry	Quasi-omni direction makes the receiver always belong to the range of a face(tracking method is required)

Table 1.2: FSO problems with possible solutions

A robust and practical FSO system should include multiple or all these features

to make a fully usage of the advantages of FSO.

1.3 Dissertation Outline

1.3.1 Contributions

We have surveyed the current situation in wireless optical communication. For outdoor applications, the adverse effects arising from absorption, scattering and shimmer are still critical and until now there is no better solution for them. So, in this dissertation, we focus on the indoor scenarios where these effects are much less that people can make the assumption of free space for the transmission medium.

For years, most of commercial optical systems are IR devices. Research and development on visible light communications become very active just in recently years. In Section 2.2.1, we introduce the most recent VLC systems. Most of them are either high speed with short range (3-5 m) point-to-point connections which are also vulnerable to signal blocking or larger coverage but with low speed for some simple applications due to high signal attenuation of diffuse link model. Robust wireless communication systems with large coverage for multiple access and continuous connectivity have not been addressed yet.

In this dissertation, we provide an indoor VLC solution, including novel network layer protocols and a novel MAC layer scheme, to solve two types of challenges, blocking of service when there is no LOS and interference from multiple access when contention occurs among existing and new user devices. As explained in Chapter 4, Multi-Spot Diffusing (MSD) could ease the blocking of service by diversity image receiver, but the complicated architecture prevents it from being adopted into any prototype yet. Several MAC schemes have been developed for VLC. Among them, only 802.15.7 standard addresses the contention due to the signal directionality. However, it still faces long latency for new enter users, transmission inefficiency in certain

scenarios (such as partial loaded network) and delay of user information. Since our solution focuses on network and MAC layer, challenges can be overcome without much additional cost on physical layer modification or circuit redesign. Furthermore, analysis also shows better performance can be achieved comparing to existing schemes. Currently, in Multimedia Communication Lab (MCL), we can achieve 2 Mb/s point-to-point video streaming for approximately 3 m by Soft Define Radio (SDR). By achieving this novel Multi-hop Multi-access VLC solution, we can improve our system to support multiple access, mobility without contention and continuous service even under Non-LOS.

The target scenario can be illustrated in Figure 3-2. A basic transmit rate of 10 Mb/s with a distance up to 3 m is achievable from access point to user device. From the access point, the total speed can be satisfied is 10 Mb/s/m^3 . When multiple access is supported, the speed of downlink per user can be up to 1 Mb/s under the satisfaction of the total rate requirement. The device on the user side should be able to support mobility without sacrificing this performance, and also rate up to 10 Mb/s between user devices through our quasi-point-to-point link model. Routing service should be available when blocking of service occurs. MAC scheme should be available to provide both smoothly switch between different access points and contention free (or reduce to accept level) within one single access point.

Specific contributions include:

- A comprehensive review of current state-of-the-art for VLC from the theoretical background to prototypes.
- A performance analysis and prediction of our VLC system in a pre-defined indoor scenario with a FSO signal attenuation model.
- Signaling analysis and simulation of DMT for FSO to improve the rate and

reliability. The result shows a significant improvement of DMT over OOK in terms of potential channel capacity.

- Two novel network protocols that can solve the block of service challenge and enable the users to fully utilize the capacity provided by access point and user devices.
- A novel MAC scheme to solve the contention caused by mobile users, reduce the latency for new enter users and keep continuous tracking on user information.

1.3.2 Organization

The remainder of this dissertation is structured as follows:

Chapter 2 describes the state-of-the-art of FSO, especially with LED. It covers regulations and standards, link model considerations, modulation techniques, Multi-Input Multi-Output (MIMO) configurations and several research groups with their research results and prototypes. Understanding these unique characteristics will show us how VLC distinguishes from other wireless technologies and where it could be deployed.

Chapter 3 is considered as signaling research on indoor VLC systems. It describes the model and proposed system architecture for indoor applications. It also covers analysis and predictions of the performance based on different configurations. The results reveal that although blue filtering can enhance the modulation bandwidth from 2 MHz to 20 MHz, the facts of reducing optical power by 0.09 mW per LED and increasing the shot noise variance still result degradation of SNR and BER.

Furthermore, a general discussion on DMT for indoor scenario is given to demonstrate why it is popular among current VLC research. From analysis,

DMT is able to improve the potential channel capacity by 4 to 5 times (depending on SNR and Direct Current (DC) bias) over OOK.

Chapter 4 proposes our multi-hop multi-access VLC solution. It contains two parts which solve two critical challenges due to the unique characteristics of VLC.

The first part describes my research achievement on solving the blocking of service challenges. Two novel network layer protocols are introduced with numerical analysis and application discussion. The results show satisfying rate performances that meet our project goals (e.g., in a 4 user case, with 10 Mb/s device, each user can have more than 1.5 Mb/s uplink and links between other users), and the adoption of each protocol depends on the desired behavior of the communication model.

The second part describes a novel MAC scheme for indoor VLC systems. A comprehensive discussion is also given to explain the uniqueness and criticalness of the interference challenge. Besides the advantage on solving interference, the results show that it can shorten the latency by more than 50 percent with about 6 percent sacrifice on throughput in fully loaded network comparing to 802.15.7 standard. Furthermore, when user devices do not always have transmission, it will have an improved throughput and even outperform 802.15.7 standard.

Chapter 5 concludes with a summary of contributions made in this dissertation, and overviews avenues for further research.

Chapter 2

Wireless Optical Communications

2.1 Background

In order to have a better understanding of the research in this dissertation and all other aspects of VLC, we give an overview of the broad area of wireless optical communications. We describe several VLC prototypes and highlight some of the key features of these applications.

2.1.1 Regulations and Standards

We can mainly divide all regulations and standards related to FSO into two categories based on the carrier medium: visible light and IR.

VLC

Using visible light as transmission medium is attracting more and more attentions due to the fast development of new visible LED devices. In current LED market, a LUXEON Rebel White can have a typical 135 lm/W [PHI], comparing with luminous efficacy around 15 lm/W for typical 100W incandescents and 60 lm/W for most 13W compact fluorescents. Hence, this is brighter than a 60W bulb and yet draws a current provided by 4 D-size batteries. Also, comparing to traditional illuminating devices which only use 20 to 30 percent of the power for illumination, LEDs spend more than 90 percent for illumination, which is much more energy efficient.

Japan is very active in putting visible light into communication purpose. In 2003,

they organized “Visible-Light Communication Consortium (VLCC)” [VLC]. This is the first organization fully concentrating on this area. In 2006, they create a standard “Visible-Light Tag” for low data rate applications such as sending various ID from LED light. Later in 2007, it proposed two visible light standards to Japan Electronics and Information Technology Industries Association (JEITA) [Har08], CP-1221 and CP-1222. Both standards are focusing on low rates applications for communication system and ID system respectively. In the mean time, starting from 2008, VLCC is also collaborating with Infrared Communication Systems Association (ICSA) and Infrared Data Association (IrDA) [Mat09]. The only change in the new VLC standard with IrDA that different from the IrDA protocols is the analogue PHY. A further physical layer specification is approved recently [Con09]. The visible light communication link supports optical link uses visible light whose wavelength ranges from 400nm to 780nm. The data rate in the first version is 4 Mb/s. The visible light packet format follows the IrDA packet format defined in [Ass97]. There are two modulation schemes of visible light communication of 4 Mb/s: inverted 4PPM and Manchester Code Data Modulation. Both schemes include DC offset to allow control of illumination intensity. When a transmitter does not send any packet, idling packet which is synchronized with data packet is transmitted.

The Institute of Electrical and Electronics Engineers (IEEE) 802.15.7 Task Group establishes a new standard for Visible Light Communication. The most recent specification came out last year [oEG11]. The operated band is between 380 nm and 780 nm wavelengths which covers whole visible light band. OOK and Variable Pulse Position Modulation (VPPM) are used with data rates in the tens to hundreds of kb/s for outdoor usage with low data rate applications and with data rates in the tens of Mb/s for indoor usage with moderate data rate applications, while Color Shift Keying (CSK) is used with data rates in the tens of Mb/s for applications that has multiple

light sources and detectors. Furthermore, this standard shares the same MAC scheme with IEEE 802.15.4 standard. In Chapter 4, we will discuss the potential problem in this standard and compare it with Carrier Sense Multiple Access with Collision Avoidance (CSMA/CA) and our proposed MAC scheme in terms of latency and rate.

Table 2.1: Summary of Current VLC Standards

Title	Distance	Rates	Region	Applications
Visible Light Communication System Standard	unknown	b/s-Mb/s	Japan	Low rate p2p
Visible Light ID System Standard	unknown	4.8 kb/s	Japan	Low rates for IDs and tags
ICSA extension	Several m	10 Mb/s	Japan	Indoor WLAN
IrDA extension	>3 meters	576 kb/s-4 Mb/s	Global	High rate 1-to-N half duplex
	several m	300 b/s-9.6 kb/s	Global	Low rate 1-to-N diffuse link
VLC	unknown	4 Mb/s	Japan	Extension of CP-1221,1222
IEEE 802.15.7	several m	10's kb/s-10's Mb/s	Global	Indoor cases

IR

We briefly go through the regulations and standards of IR. The most important issue of wireless optical communication is eye safety: it can pass through the human cornea and be focused by the lens onto the retina, where it can potentially induce thermal damage. Since human eyes can have the awareness of the existence of visible light, there are additional power regulations on IR which VLC doesn't have, such as International Electrotechnical Commission (IEC) (IEC60825-1) [Com93] and American National Standards Institute (ANSI) (ANSI Z136.1) [Ins93]. They constrain the power budget of optical device under certain levels. We will not go to the details of them. One fact needed to mention is LED is large area emitter, and thus can be

operated at relatively higher power when comparing to laser device, and therefore make it a better choice for indoor applications.

The most common standard about the wireless optical system is established by IrDA in 1993 to create and promote inter-operable low cost IR data interconnection. Its Serial Infrared Physical Layer defines standards for half-duplex point-to-point links at several bit rates up to 4 Mb/s with 4-PPM, while 1.152 Mb/s links utilize OOK with Return-to-Zero (RZ) pulses having a duty cycle of 0.25. Most IrDA receivers adopt diffuse link, so that most IrDA links are of the hybrid-LOS type, which means the transmitter and receiver are employed with different degree of directionality while they still maintain LOS during transmission as shown in Figure 2-1. The transmitter must have a peak-power wavelength between 850 nm and 900 nm. The normal range is 1 m, however, in many cases, the range of links can extended as long as 3 m. Later, Advanced Infrared (AIr) was developed to improve the performance such as throughput. The speed for point-to-point link has been accelerated to 16 Mb/s and it starts to support diffuse link with a data rate up to 4 Mb/s with repetition coding [Ass97].

Another standard which defines optical signal communication is the well-known IEEE 802.11 standard for IR. It defines two data rates, 1 Mb/s and 2 Mb/s, and uses 16-PPM and 4-PPM (Figure 2-5) respectively which results in the same chip rate, 4 M chips per second. It also uses the IR signal between 850 nm and 950 nm, and achieves the communication range up to 10 m.

2.1.2 Link Topologies

The performance of the wireless optical communication can vary significantly depending on the topology of the link model used. [KB97] demonstrates the classification of simple link models as shown in Figure 2-1. The first criterion is the degree of direction-

ality of the transmitter and receiver. Directed links employ directional transmitters and receivers, which must be aimed in order to establish a link, while non-directed links employ wide FOV transmitters and receivers. Directed link design maximizes power efficiency, since it minimizes signal attenuation and reception of ambient light noise. On the other hand, non-directed links may be more convenient to use, particularly for mobile devices, since they do not require aiming of the transmitter or receiver.

Another classification criterion relates to whether the link relies upon the existence of an uninterrupted LOS path between the transmitter and receiver. LOS links rely upon such a path, while non-LOS links generally rely upon reflection of the light from the ceiling or some other diffusely reflecting surface. LOS link design maximizes power efficiency and minimizes multipath distortion. Non-LOS link design increases link robustness, allowing the link to operate even when barriers stand between the transmitter and receiver.

We will only discuss three wireless optical communication link models and compare the channel characteristics of them. Detailed information can be found from many papers, including [KB97] and [Hra04].

Point-to-Point Links

Point-to-point link model is the first one in the first row of Figure 2.1. As its name, when you use this model, transceivers communicate with each other by a thin light beam. So, it requires that there is a direct, unobstructed path between them. In narrow FOV applications, this oriented configuration allows the receiver to reject ambient light noise and achieve high data rate and low signal attenuation. However, such strict requirement of LOS is very sensitive to blocking and shadowing.

This link model has been widely introduced by IrDA for years for short range

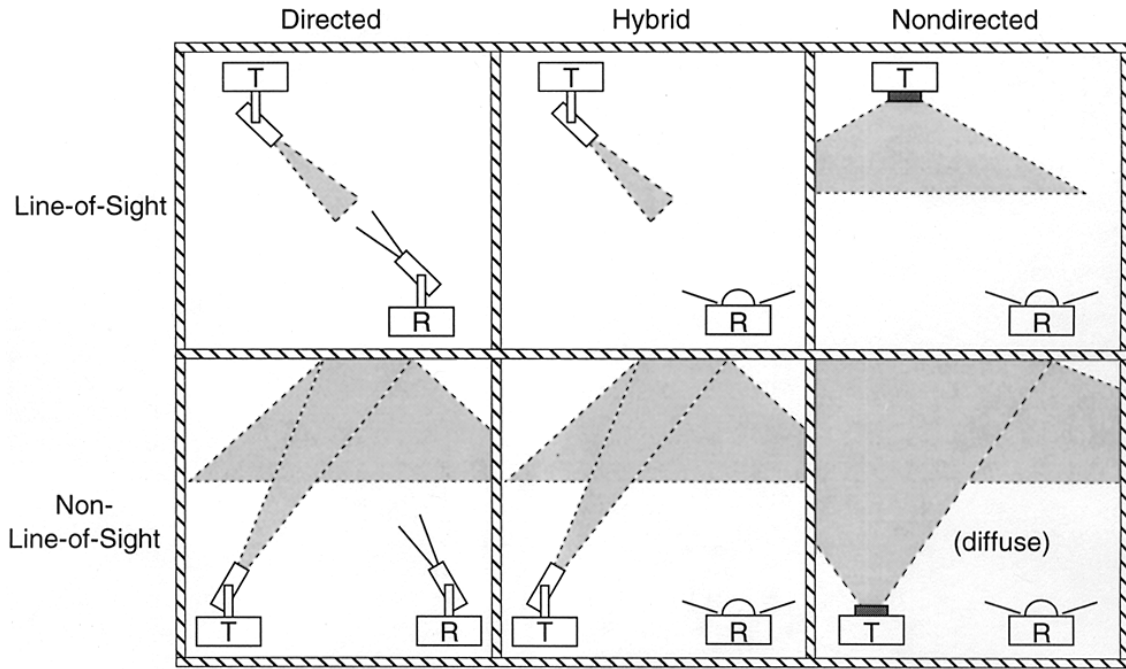

Figure 2-1: Classification of simple links according to the degree of directionality of the transmitter and receiver and whether the link relies upon the existence of a LOS path between them [KB97]

applications. For medium and long range transmission, 10 Mb/s and 100 Mb/s point-to-point wireless infrared links to extend Ethernet networks have been developed over a range of at most 10 m in an office environment by JVC [JVC] and Plaintree Systems Inc. [Pla] respectively. Furthermore, the point-to-point link model can be extended to the long range applications, such as Gb/s over 4 km [TNSP99], earth-to-space at rate in excess of 1 Mb/s [WE00] and even for searching the extraterrestrial intelligence [Pto].

Another solution of point-to-point links is space division multiplexing architecture by which a transmitter outputs different data in different spatial directions to allow for the simultaneous use of one wavelength by multiple users. Another means of implementing a space division multiplexing system is to use a tracked optical wireless architecture. In such system, the beams are steerable under the control of a tracking

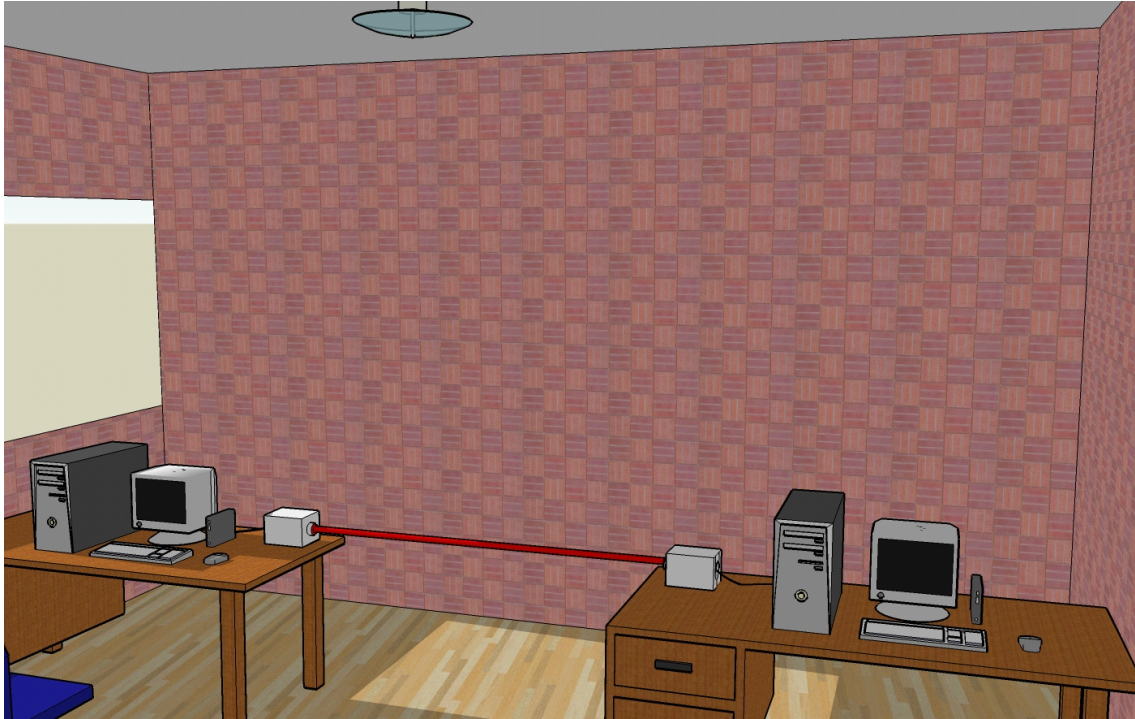

Figure 2·2: Point-to-Point link model

subsystem. These systems are proposed to provide up to 155 Mb/s ATM access to mobile terminals in a room [BSWG99] and build a simple testbed for single user. Recently with the researchers from University of Oxford and Cambridge University, they built the prototype of IR transceivers capable of 100 Mb/s Manchester coded data streaming in a very short range (10 cm) [OFJ+06].

Diffuse Links

Diffuse link model is more like RF communication. In Figure 2·1, both the third of the first row and the second row can be considered as diffuse link model. Rather than a beam, the signal is radiated over a wide solid angle in order to solve the pointing and shadowing problems of point-to-point link model. This allows receivers have some mobility at the expense of a high data loss and ISI caused by multipath distortion. Such multipath distortion gives rise to a channel bandwidth limit of approximately

10-200 MHz [KKC95] [CK97]. Example IR devices are introduced in [Dif], [Smi98] and [OFJ⁺06].



Figure 2-3: Diffuse link model

However, the diffuse link is free of multipath fading. This is because the short carrier wavelength and large-area, square-law detector lead to efficient spatial diversity that prevents multipath fading, and hence no change in the channel response is noted if the photon detector is moved a distance on the order of a wavelength [KB97] and [KKC95].

Experimental results have demonstrated a 50 Mb/s diffuse IR communication link within 3 m for indoor applications [MK96]. In the commercial market, products have been provided for many applications such as set-top box with claimed data rate up to 5 Mb/s [Dif]. Another famous early application of diffuse link wireless optical communication is the Active Badge System developed by Olivetti Research

Labs from 1989. People wear personal identification cards which emit infrared signal to the receivers with a unique code in current room. With such signals, system can collect the location information of each individual for certain purposes [Smi98].

Quasi-Diffuse Links



Figure 2.4: Quasi-Diffuse link model

Quasi-diffuse link model is a combination of point-to-point link model and diffuse link model. The first and second one of the second row in Figure 2.1 can be considered as Quasi-diffuse link model. In this model, the transmitter illuminates the ceiling with multiple signal beams which form a grid of spot on the ceiling. In practical, such narrow beams can be created either by individual light sources or holographic beam splitters. On the other hand, the receiver either has multiple photon detectors with non-overlapping FOV or one large FOV to cover a great portion of the ceiling. This link model is also considered as a MIMO configuration which is named MSD

[AKJ04], [AK03] and [JHK04]. We discuss more in the Section 2.1.5.

Comparison

Characteristics	Point-to-point	Diffuse	Quasi-diffuse
Range(up to)	Long	Moderate	Moderate
Rate	High	Low	Moderate
LOS	Yes	No	No
Mobility	No	Yes	Yes
Implementation Cost	Low	Moderate	High

Table 2.2: Comparison among three link models

We have presented three major link models of wireless optical communication. The point-to-point link model is a low complexity means to achieve high data rate at the expense of mobility and pointing requirements. Diffuse link model suffers from high signal attenuation and multipath distortion but can offers a great degree of mobility and robustness to blocking. Quasi-diffuse link model has advantages from both of two previous models but has a higher implementation cost. By summarizing the discussion and publications mentioned, we have a general comparison among the three basic link models in Table 2.2. Therefore, we can see that due to its many unique characteristics, wireless optical communication is very application oriented depending on required data rates and channel conditions.

Furthermore, as described later in Section 2.1.5, Quasi-diffuse link model may not be a good choice since the light source is from the ceiling which also acts a lamp for illumination. The main question is how to overcome the signal attenuation and background noise for the diffuse link. This is essential for achieving high rate. One possible solution is discussed in the Section 3.3. Also, another difference we are trying to make is to build a device more universal for different services which may have different critical requirements. The discussions of these two parts are included later in this dissertation.

2.1.3 Modulation Schemes

The modulation of FSO is different from the RF. Currently the most viable modulation is Intensity Modulation (IM), in which the desired waveform is modulated onto the instantaneous power of the carrier. Correspondingly, the most practical method at receive side is Direct Detection (DD), in which a photon detector produces a current proportional to the received instantaneous power.

There are several different signal modulation schemes. In this section, we only introduce some simple and popular schemes from [Hra04], particularly on their basic types for the purpose of brevity. Currently, most popular schemes in used in this area are binary-level for the reasons of simple and inexpensive implementations. Other complex schemes can provide higher bandwidth efficiency with the tradeoff on power efficiency and robustness.

	Bit Rate	Bandwidth Efficiency	BER
OOK	$\frac{1}{T}$ bit/s	1 bit/s/Hz	$Q\left(\frac{P}{\sqrt{R\sigma^2}}\right)$
PPM	$\frac{\log_2 M}{T}$ bit/s	$\frac{1}{M} \log_2 M$ bit/s/Hz	$\frac{M}{2} Q\left(P \sqrt{\frac{M \log_2 M}{2R\sigma^2}}\right)$
PAM	$\frac{\log_2 M}{T}$ bit/s	$\log_2 M$ bit/s/Hz	$\frac{2(M-1)}{M \log_2 M} Q\left(\frac{P}{M-1} \sqrt{\frac{\log_2 M}{R\sigma^2}}\right)$
QAM	$\frac{\log_2 M^2}{T}$ bit/s	$\log_2 M$ bit/s/Hz	$\frac{2(M-1)}{M \log_2 M} Q\left(\frac{P}{M-1} \sqrt{\frac{\log_2 M}{2R\sigma^2}}\right)$

Table 2.3: Characteristics of different modulation schemes [Hra04]

On-Off Keying

OOK is a very popular scheme not only in wireless optical communication, but also in other data communication. It is also called Non-Return-Zero (NRZ) encoding scheme. In each symbol interval one of two symbols consisted of constant intensities of zero or $2P$ is transmitted. The constellation for OOK consists of two points in a one dimensional space. It is the simplest modulation scheme of FSO.

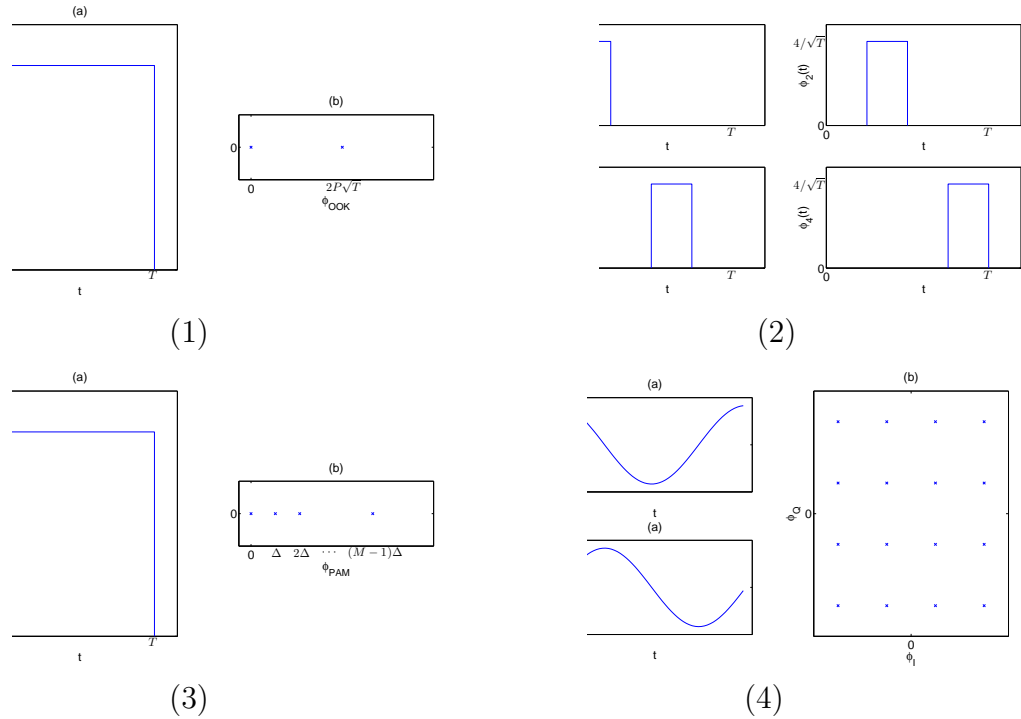

Figure 2-5: Basis function (a) and Constellation of Symbols (b) for (1)OOK, (2)4-PPM, (3)PAM and (4)QAM

Pulse-Position Modulation

PPM is a standard modulation scheme used in wireless optical communication which has been widely adapted previously in IR [Ass97]. It uses two distinct intensity levels and each symbol interval is divided into M chips with same width. Information is sent by putting only one of the chips non-zero. In this scheme, the signal space of M -PPM is an M dimensional space with a single constellation point on each of the M axes.

Pulse Amplitude Modulation

Pulse Amplitude Modulation (PAM) is a generalization of OOK from a set of two symbols to a set of M symbols. It is a very basic scheme in RF communication. The basis function is the same with OOK. The only difference is now we have a set of

non-negative scale factors instead of two. As a result, OOK is actually a special case of rectangular PAM. PAM has all the constellation points in the same dimension.

Quadrature Amplitude Modulation

Quadrature amplitude modulation (QAM) is very popular in many communication systems for achieving high speed data rate. Generally, the M^2 symbols of M^2 -QAM consist of an in-phase and quadrature component basis functions which are orthogonal to each other due to the property of sinusoids. In addition, because the optical signal has to be non-negative, a DC bias offset needed to be added to meet such requirement. So, this scheme is bandwidth efficient with the expense of energy inefficiency [Hra04].

2.1.4 Channel Model

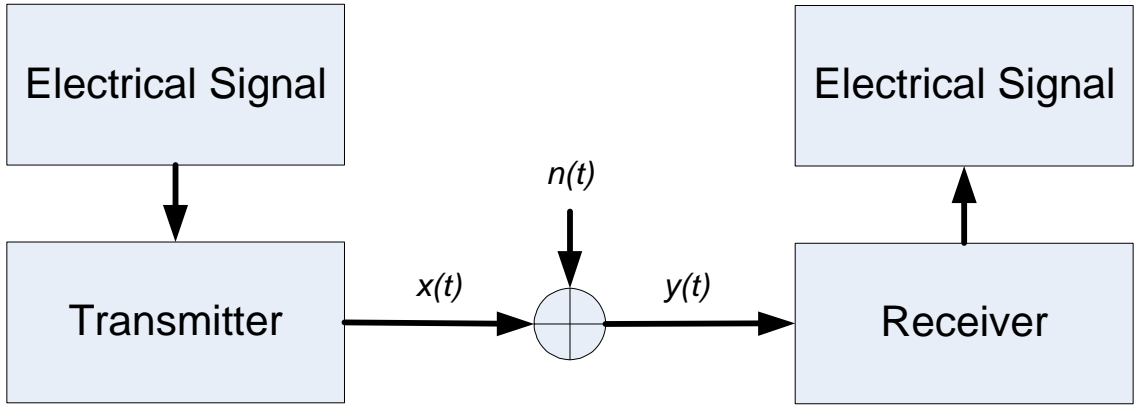

Figure 2-6: Communication system model for optical intensity channel

Optical communications use IM/DD where the information is encoded by varying the instantaneous optical intensity of the source. In the far-field case, the channel response from transmitted intensity $I(t)$, to the receive photocurrent $y(t)$, in Figure 2-6 is well approximated as

$$y(t) = r \frac{I(t)}{D^2} \otimes h(t) + n(t),$$

where r is the detector sensitivity, D is the distance between transmitter and receiver, $n(t)$ is the noise process and $h(t)$ is the channel response [KB97, KKC95, CK97].

Because LEDs above threshold perform a near linear conversion between the input drive current and the output optical intensity [KB97] [KKC95], the electro-optical conversion can be modeled as $I(t) = gx(t)$ where g is the optical gain of the device. Without loss of generality, we set $rg = 1$ and let the $1/D^2$ be lumped into $h(t)$, then we have

$$y(t) = x(t) \otimes h(t) + n(t).$$

Different from RF, optical signal suffers from great signal attenuation after reflection (Non-LOS) [KB97]. Therefore, multipath effect is smaller for FSO system. Furthermore, because multipath time spreading of the light is small compared to the symbol interval (T_s) of the signal, it is reasonable to neglect ISI. This assumption is valid for two types of systems: 1. links using focused light where there can be no significant multipath components and 2. systems with bandwidth constraints below 10-100 MHz which have long symbol intervals.

Even though, channel response, $h(t)$, is still a complex case-by-case problem which is closely related to several parameters, such as location, size and the orientation of the receiver and transmitter. Normally, for a wireless channel, there are three steps for impulse response: measurement, simulation, and modeling. Channel measurements have been described in several studies [KKC95, HYK⁺94]. These give us some fundamental understanding about the properties of certain environments of the channel by generating a collection of hundreds of or thousands of example impulse responses. Also, these researchers continue with the measurements based on a site-specific characterization of the propagation environment [BKK⁺93, AH95]. For the last step of characterizing the impulse response, [CK97] has extracted a simple model based on

previous steps of work which only use two parameters (signal attenuation and delay spread) to characterize most general diffuse IR channels.

For most FSO systems where ambient light is strong to make the shot noise, which will be discussed later, Gaussian, channel characteristic normally acts like lowpass [Hra04], which means under certain bandwidth the relation between $y(t)$ and $x(t)$ is linear. So, in most of researches, the channel is just considered as a baseband and it is also one reason that the practical bandwidth is limited. Therefore, we can consider the impulse response $h(t) = H_0\delta(t)$.

Another particular constraint is the optical power due to eye and skin safety requirements as described in Section 2.1.1. Different from RF where the constraint is on the degree of square of the intensity, the constraint for FSO is on the degree of non-negative amplitude itself.

The discussion of $n(t)$ is more complex. As is the case in RF communication, the determination of noise sources as the input of the receiver is critical since this is the location where the incoming signal contains the least power. Generally, there are two major types of noise.

Thermal Noise

Thermal noise, or circuit noise, is a random fluctuation in voltage caused by the random motion of the receiving electronics [Ros]. A major source is the noise caused by resistive elements in the pre-amplifier. Thermal noise is generated independently of the received signal and can be modeled as having a Gaussian distribution and in general, is non-white [KB97].

Shot Noise

Photon-generated shot noise is a major noise source in the wireless optical communication. It arises due to both the ambient light and transmitted signal. Many wireless

optical links operate in the scenarios where there is intense background illumination. In these cases, the ambient light shot noise component dominates the shot noise, and therefore is the dominant source of noise in a wireless optical channel [Hra04].

This random process arises fundamentally due to the discrete nature of energy and charge in the photodiode, which normally can be modeled as having a Poisson distribution with a white power spectral density [KOG70]. So, the high intensity shot noise is the result of the summation of many independent, Poisson distributed random variables. In the limit, the cumulative distribution approaches a Gaussian distribution. Thus, for most of indoor wireless optical communication the noise source is normally modeled as a white, signal independent Gaussian distribution [Hra04].

Narrow FOV links are able to reject a large component of ambient light. The resulting noise can still be modeled as being Gaussian distributed but dependent on the transmitted signal. In the case of wide FOV receivers, where the ambient light dominates the received signal, it is modeled as additive, white, signal independent Gaussian distribution with zero mean and variance σ^2 (AWGN) [KB97, Car03, Hra04].

Furthermore, the Power Spectral Density (PSD) of shot noise is

$$S_{shot}(f) = 2qRP_n,$$

where q is the electronic charge, R is the responsivity and P_n is the average power of ambient light. Therefore, the SNR will be

$$SNR = \frac{R^2 P^2}{\sigma_{shot}^2} = \frac{R^2 P^2}{2qRP_n I R_b},$$

where P is the average power of desired signal, I is noise-bandwidth factor and R_b is the data rate [KB97]. Besides these parameters, SNR is also related to spectral irradiance, ambient light angle, peak transmission and noise bandwidth of the optical filter, detector physical area and refractive index of the concentrator. So, the numer-

ical result SNR can be varied in a wide range. A typical value is within 10 to 20 dB depending on the link model.

For a more direct understanding about the noises in wireless optical communication, an example is given from [KB97]. The power spectral densities of different noises can be plotted in Figure 2-7, assuming parameters that might be typical of a receiver operating in a 10 Mb/s diffuse link.

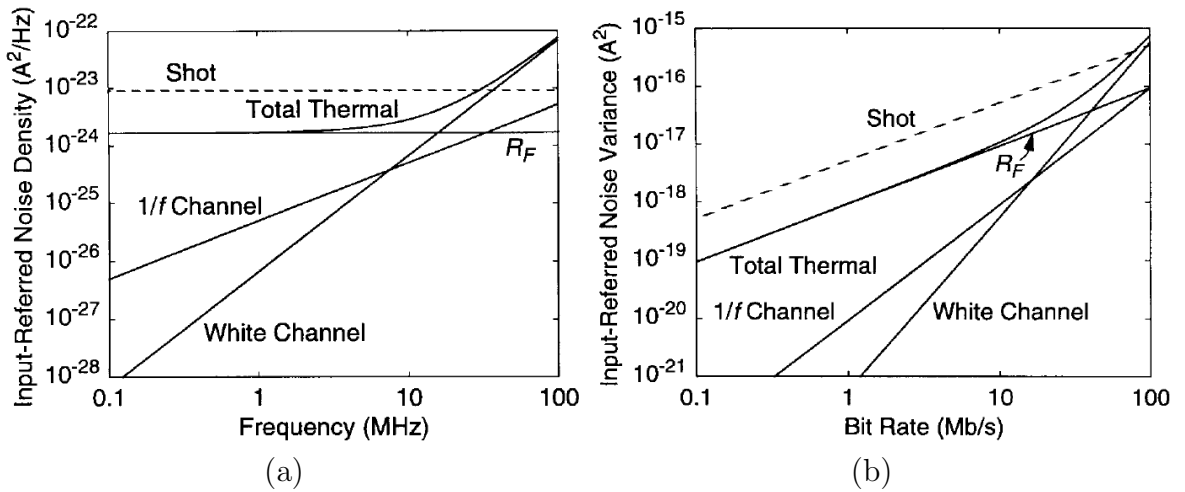

Figure 2-7: (a) Dominant input-referred noise power spectral densities
(b) Dominant input-referred noise variances [KB97]

2.1.5 Multi-Input Multi-Output

MIMO system is the use of multiple antennas at both the transmitter and receiver to improve communication performance. Those multiple antennas used in either transmitters or receivers will create more signal passage channels under the condition that they will be able to be separated at the receiver without mutual interference. Only in this way, the signals flows independence among different TxCRx channels can be exploited to achieve certain kinds of gains in “spatial diversity” or “multiplexing”, depending on the applications.

In FSO, there are several research conducted on this topic. In [WBPCL05], [TO04] [NUL04] and [SHJ05], authors give us some fundamental research on the general study of MIMO system in wireless optical channels. In the mean time, two unique types of MIMO system are studied due to unique characteristics of the practical configurations.

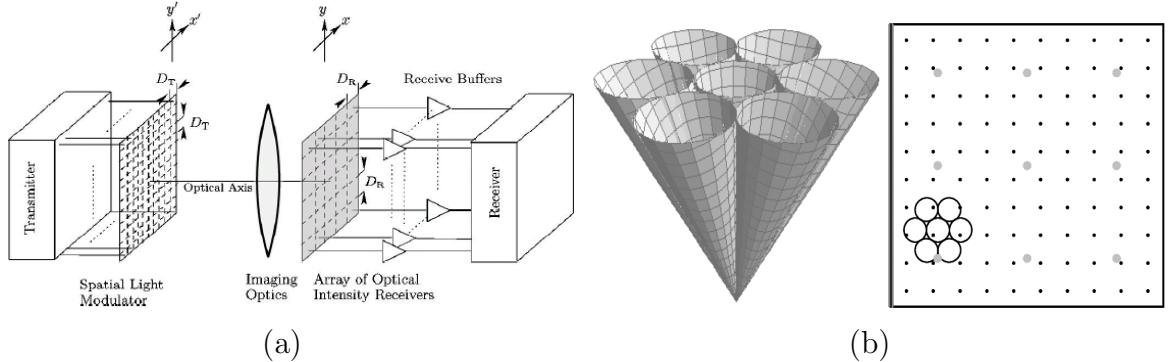

Figure 2-8: (a) Pixelated system [HK06] (b) MSD system [AKJ04]

In [Hra04] and [HK06], authors introduce a pixelated wireless optical system, which transmits data at high rates using a series of coded time-varying images in a short range (2m). The pixelated wireless optical channel is ideally suited to applications that require high speed short range communication in which a LOS is available. However, the requirement of LOS limits its applications. The communication distance is too short to make it a good solution for more general indoor cases. Furthermore, physical movement like rotation can greatly affect performance. Mainly, it is only considered for some personal device usages.

Another type of MIMO system, MSD, is introduced by Kavehrad [AKJ04], [AK03] and [JHK04]. It has been mentioned as Quasi-Diffuse links in previous section. The desktop level transmitter sends out multiple identical narrow beams, which have small signal attenuation, to illuminate small size areas on the ceiling, called diffusing spots. Then after reflecting, each spot can be considered as a lighting source with a Lambertian illumination pattern. An angle diversity receiver which has multiple

narrow non-overlapping FOV receiving elements is used to provide diversity gain.

Recently, there are new FSO systems adopting MIMO in the traditional way to demonstrate higher transmission rate or avoid interference. They are introduced in Section 2.2.

2.1.6 Direct Sequence Spread Spectrum

Direct Sequence Spread Spectrum (DSSS), also refers to Direct Sequence Code Division Multiple Access (DS-CDMA), is a much more complex scheme which handles the channel access from the aspect of signaling. DSSS is one in which the transmitted signal is spread over a wide frequency band, much wider than the minimum bandwidth required to transmit the information being sent. Band spreading is accomplished by means of a Pseudo-Noise (PN) code, quasi-orthogonal or orthogonal codes, which is independent of the data. When the PN codes have a good orthogonal property, modulated signal can be recovered with a simple Rake receiver. The initial purpose of DSSS is military anti-jamming tactical communications for its property of noise-like signal to each other. However, after that, researchers explore its usage in wireless communication mainly for its property of simultaneously sharing of the transmission medium.

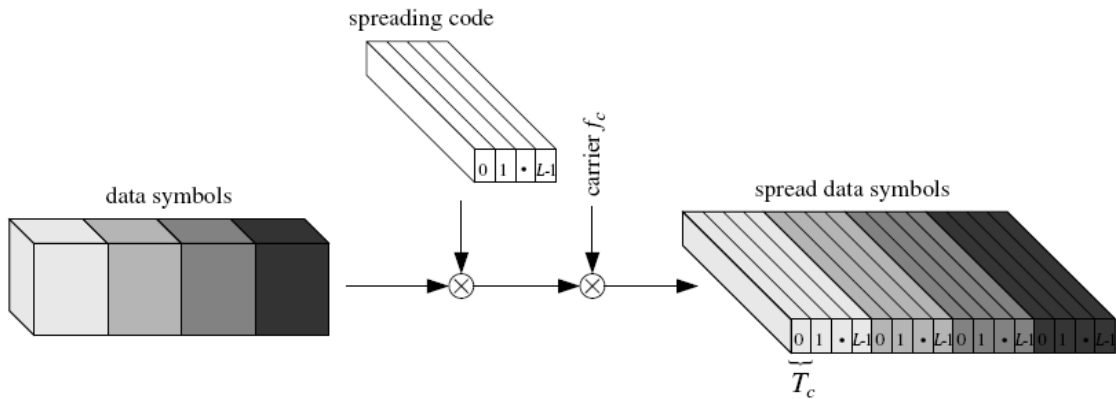

Figure 2-9: Direct Sequence Spread Spectrum [FK03]

The choice of code sequences is important. Different from coherent CDMA that using bipolar codes, in optical communication, the signal is non-negative that only unipolar codes can work. One good candidate is Optical Orthogonal Codes (OOC) [CSW89]. It can provide asynchronous multiple access communications with easy synchronization and good performance in CDMA communication networks.

Although there is no need to synchronize data between different transmitters, synchronization between transceivers is still needed. It consists of two stages, namely, acquisition and tracking. They function similarly but are responsible for OOC and data respectively. A simple serial-search method is demonstrated in [KS01].

However, the benefit comes with a great expensive on Multi Access Interference (MAI), lower Signal-to-Interference-plus-Noise Ratio (SINR) per degree of freedom of the individual links. The more users accepted in the system, the more severe of the problem. Furthermore, the near-far problem occurs when the power of the signal received from one transmitter is so strong that the signal received from other transmitter is completely jammed.

2.2 Related Works

In this section, we demonstrate some VLC prototypes designed by the researchers. Some of them are for outdoor purposes, and some for indoor applications. Some can support high speed rate requirement like High-Definition (HD) video streaming, and Some are suitable for low rate systems like in-building tracking. By having an overview of these state-of-the-art achievements, we can have a more direct idea about where the VLC system can be used.

2.2.1 Prototypes

We first start with research groups which have demonstrated their prototype VLC systems. Figure 2·10 shows most VLC prototypes introduced in recent years for indoor applications with the range shorter than 10 m.

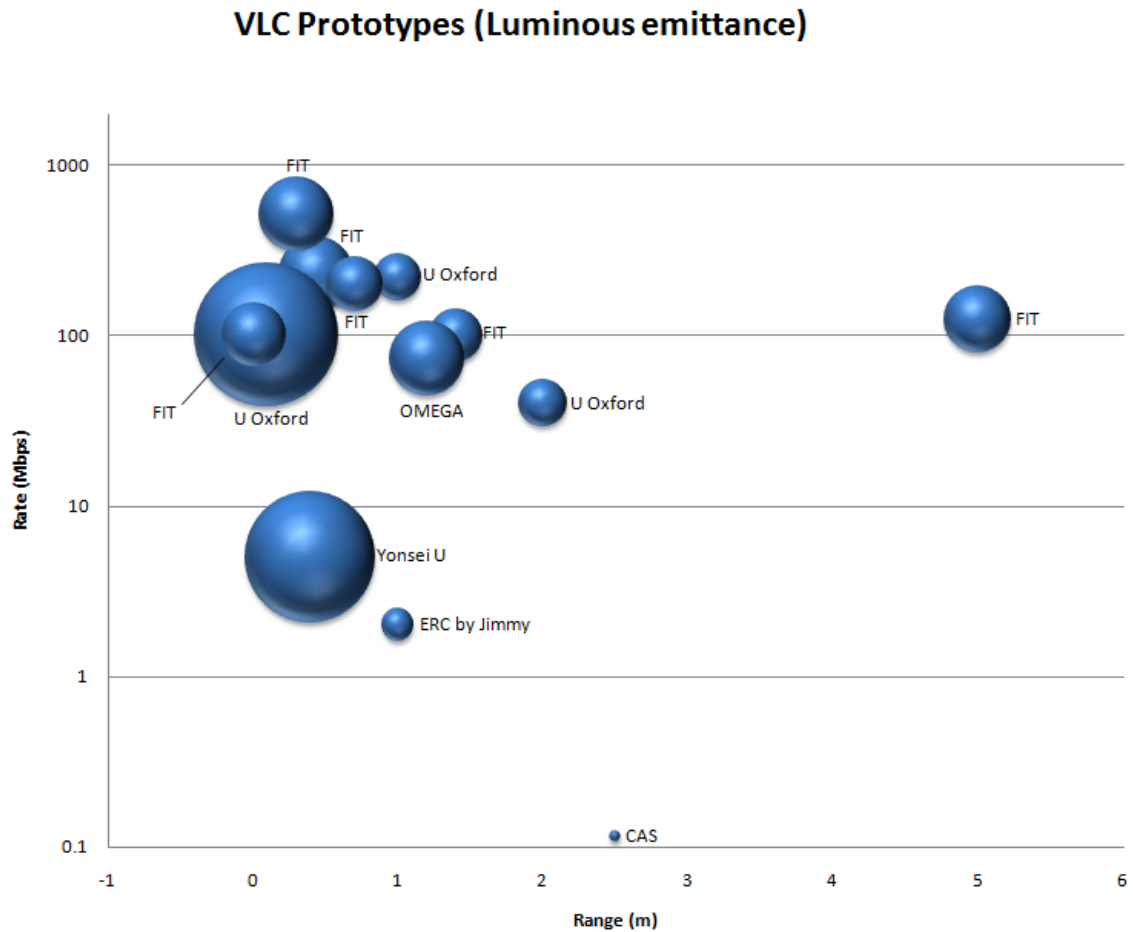

Figure 2·10: Short range (<10 m) VLC Prototypes with Visible Light Medium [GRLW08a] [VKN⁺09b] [VKN⁺09a] [VFK⁺10] [VKN⁺10b] [VKN⁺10a] [MOF⁺09] [MOF⁺08b] [ATO10] [BPW⁺10] [ASWH09] [YCZ⁺09]

The size of the dot represents the luminous emittance of the transmitter of each

prototype. It is closely related to FOV, optical power and range.

$$M_v = \frac{F}{S}$$

$$= \frac{F}{\pi(R * \tan(\frac{\theta}{2}))^2},$$

where M_v is luminous emittance, F is Luminous flux, S is footprint of coverage, R is range and θ is full FOV angle at half power of LED.

So, it is a good metric to compare among different VLC systems. As indicated in the Figure 2-10, currently, most of indoor prototypes focus on high rate without consideration of range. However, a practical system should be able to support applications with longer range. Therefore, up-right corner with large dot which indicates long range, high rate and good illumination (high flux per m²) is our target.

OMEGA Project

One of the most important projects involving VLC is OMEGA project, the Home Gigabit Access project. For widespread acceptance, wireless networks are required, and the OMEGA project aims to develop gigabit home networks “with no new wires” [OME]. Such networks will use RF and optical wireless communications together with (local) power line communications. Optical wireless links will provide high-speed (Gb/s) LOS data transmission at wavelengths in the near-infrared range. In addition, novel VLC will be used to broadcast data at bit rates of 100 Mb/s while providing illumination within the home [OME].

Funded by European Union (EU) through OMEGA project, researchers from Fraunhofer Institute of Telecommunications (FIT) have been collaborating with Siemens Corporate Technology, France Telecom and other researchers on VLC. They started with some background of OMEGA project and theoretical results demonstrated in [LGB⁺08] [GRLW08b]. They considered a medium-sized model room which has ceil-

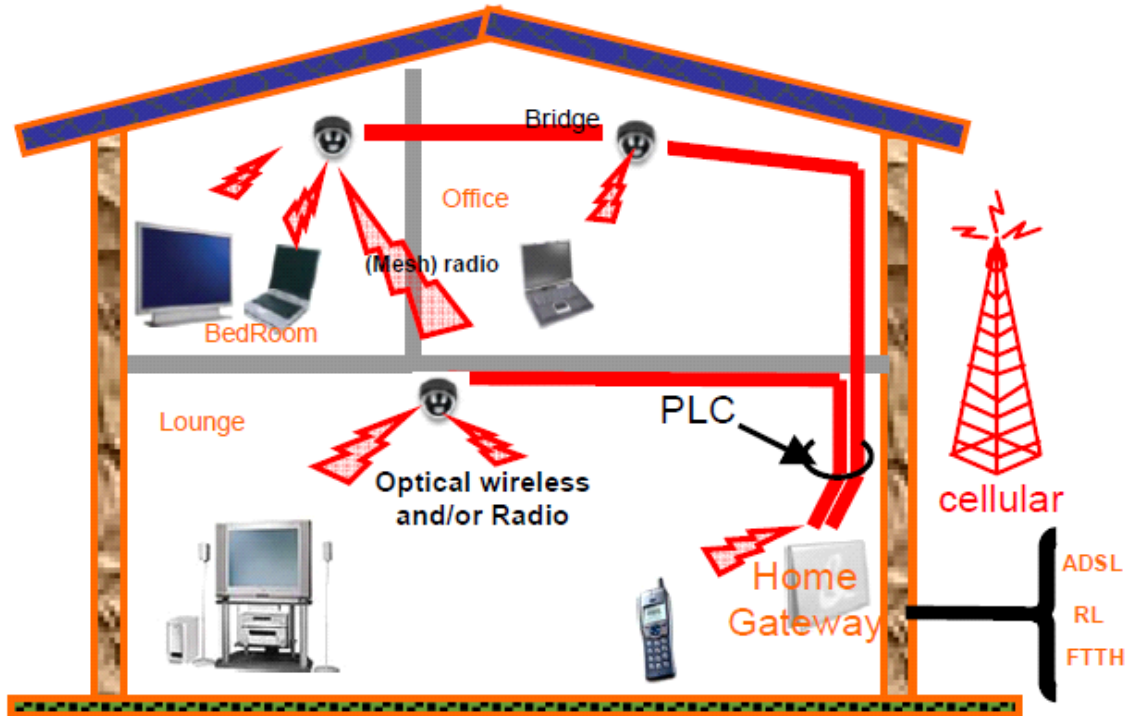

Figure 2.11: Schematic of OMEGA project [LGB⁺08]

ing lamp consisting of LEDs with 60 degree off-center angle and 20 MHz modulation bandwidth. The vertical distance from the desktop receiver to the lamp is about 1.65 meters. The simulations show that by suppressing the phosphorescent portion of the optical spectrum upon detection and adopting DMT with high order QAM, the achievable rates lie in the region of several hundred Mb/s.

In the mean time, they started implementing the research work with several experiments. In 2008, they demonstrated a simple single phosphor-based white-light LED and p-i-n photodiode prototype [GRLW08a]. Within a very short distance (1 cm) to maintain an illuminance of 700 lx at the detector plane, the system is able to carry out 40 Mb/s with OOK and 101 Mb/s with DMT. Later on, in 2009, they improved the rate of the system with OOK into 125 Mb/s at a range of 5m while having illumination levels at the receiver fit into the range recommended by the standard for

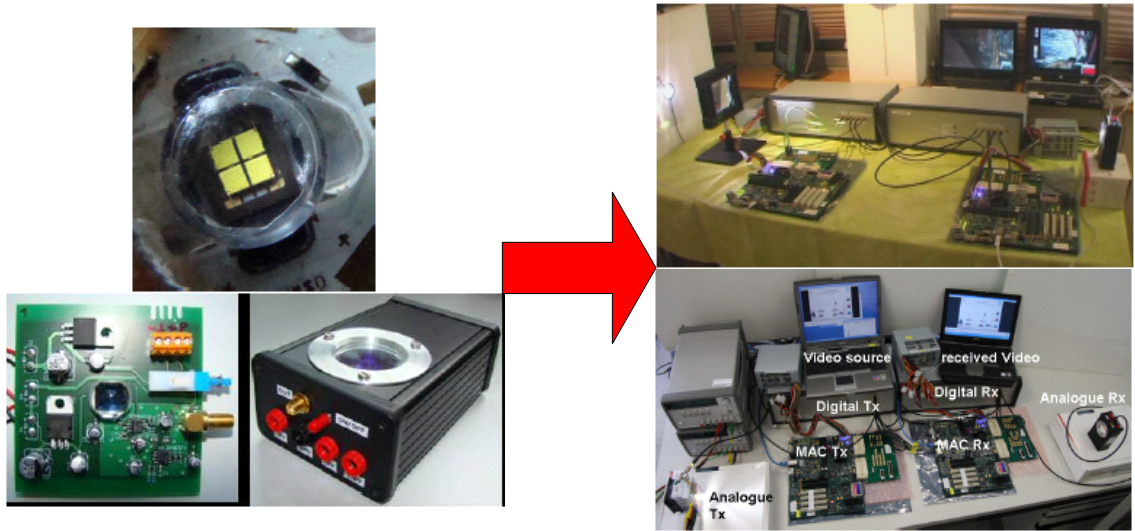

Figure 2.12: Prototypes from FIT [VFK⁺10] [BPW⁺10]

(office) general lighting [VKN⁺09b]. The same year, with both approaches of blue filtering and DMT, they were able to achieve 200+ Mb/s under 1100 lx illumination [VKN⁺09a]. However, the distance is still as short as 0.7 m. Last year, they continued with several other prototypes. In [VFK⁺10], they showed an implementation of a real-time DMT-based visible-light link operating at 100 Mbit/s using a low-cost commercially available white LED for video streaming. In [VKN⁺10a], they reported the demonstration of a visible-light link with OOK operating at 230 Mb/s with use of an Avalanche Photodiode (APD) and 125 Mb/s with use of a p-i-n photodiode, both without equalization. In [BPW⁺10], they managed to stream three HD video simultaneously by a single LED at a distance of 1.2 m with the rate of 20 Mb/s for each. In [VKN⁺10b], they finally achieved 500+ Mb/s, the fastest rate ever published until now, based on a commercial thin-film high-power phosphorescent white LED, an APD, and off-line signal processing of DMT signals.

University of Oxford

O'Brien et al. from University of Oxford are also working VLC system, partially with OMEGA project. Different from the approaches used by FIT researchers, they improve the system with MIMO and equalization techniques. In 2008, the first experiment demonstration using 16 (four by four) resonantly modulated white LEDs achieved 25 MHz modulation bandwidth and low error rate data transmission at 40 Mb/s for a link with distance of 2 m and coverage radius of 0.5 m, as well as room illumination at levels required for typical office space [MOF⁺08b]. The other one later showed 80 Mb/s with one single LED at a short range of 0.1 m [MOF⁺08a]. Both of their VLC prototypes adopted blue filtering, OOK and Pre-equalization (transmitter equalizer).

In 2009, they continued developed a prototype that can achieve 100 Mb/s with simple OOK modulation by combining the techniques of blue filtering and a different equalization technique, post-equalization (receiver equalizer). However, the experiment was still performed at a very short distance of 0.1 m [MOF⁺09].

Last year, their most recent work showed that, with Orthogonal Frequency-Division Multiplexing (OFDM) and MIMO, two by one array of white LEDs that transmit data to a nine channel imaging receiver that uses a three by three photodetector array, 220 Mb/s VLC link at a range of 1 m is available [ATO10].

As part of the OMEGA project, they are also working on high speed IR point-to-point communications. The prototype has been shown that a measured BER of 10^{-11} has been achieved for the 1.25 Gb/s NRZ-OOK (on-off keying) link over 3 m distance in a coverage area of about 0.6 m² with no forward error coding [MOF10].

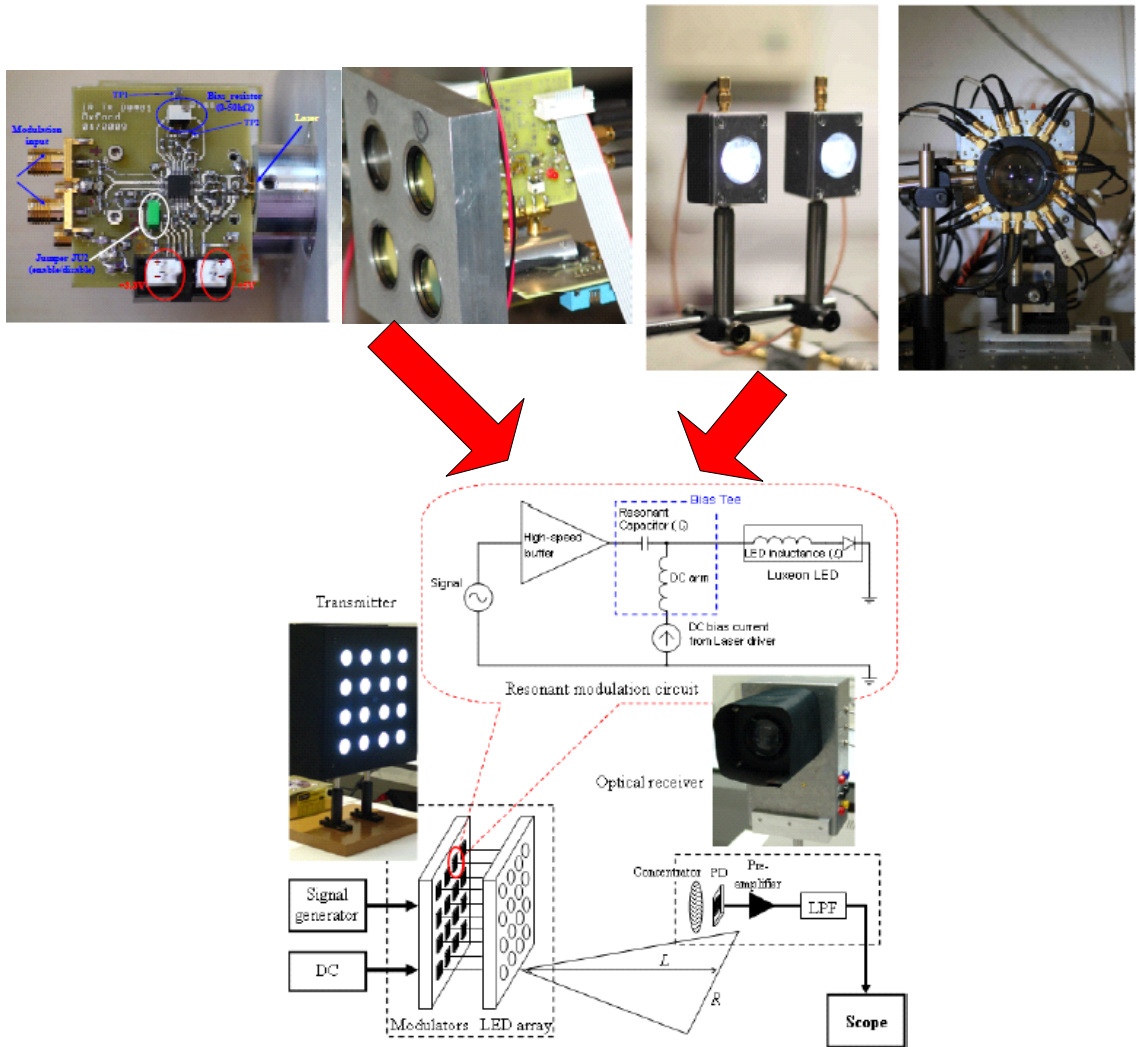

Figure 2-13: Prototypes from University of Oxford [ATO10] [MOF10]

Nagoya University

Japan is another region that is very active on VLC. Because of the close collaboration with camera companies like Canon and Nikon, their researches address very differently. First, instead of photodiode, with the advantage of camera company partners, they use image sensor for most of the time. Second, they put more effort on outdoor long distance scenarios and applications, such as vehicle networks and traffic control.

The first experiment was carried out in 2005. The experimental rate is only 2.78

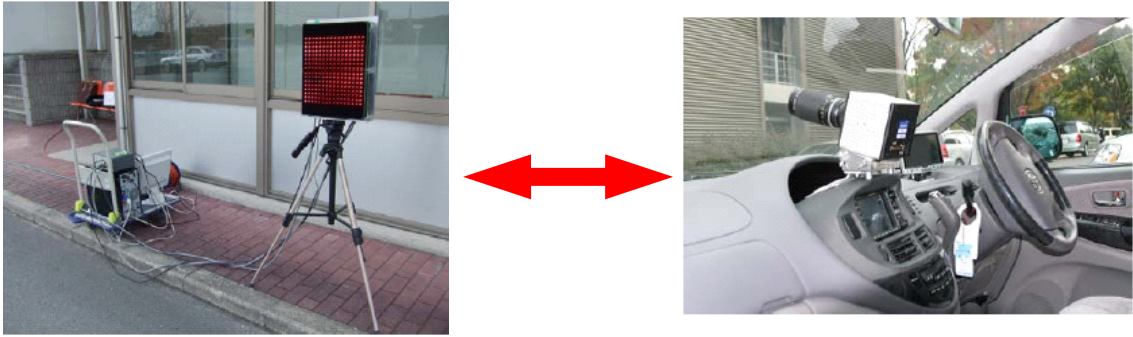

Figure 2-14: Prototypes from Nagoya University [IPE⁺08]

kb/s by a traffic light consisting of 192 LEDs within 4 meters under the laboratory conditions. Attenuation of LED light, reduction of the number of pixels to which LED is reflected and LEDs overlap in defocused image are the degradation factor of data transmission channel quality [WYFT05]. In 2008, 64 red LEDs are used for 16 parallel communications to achieve 4 kb/s transmission for the vehicle with the speed of 30 km/h [IPE⁺08]. In 2009, with their most recent demonstration, they continued improving the performance to 2 Mb/s for 40 meters and 1 Mb/s for 60 meters with tracking and vibration correction techniques with the similar traffic lights [OYY⁺09].

Keio University

From another Japanese institute, Keio University, Haruyama and other researchers are also conducting intensive research on VLC. Similar with their colleagues from Nagoya University, image sensor is their choice for receiver. However, their works are more diverse on both indoor and outdoor situations.

In 2008, their presented the prototype for Visible Light Road-to-Vehicle Communication [SHN08]. The work is very similar to Nagoya University's work. It uses image sensor to pick up the low speed tracking signal (1 kb/s) from traffic light in a range near 50 m. The motor controller calculated and centralized the photodiode to the traffic light for high speed data transmission (10 Mb/s). In the same year,

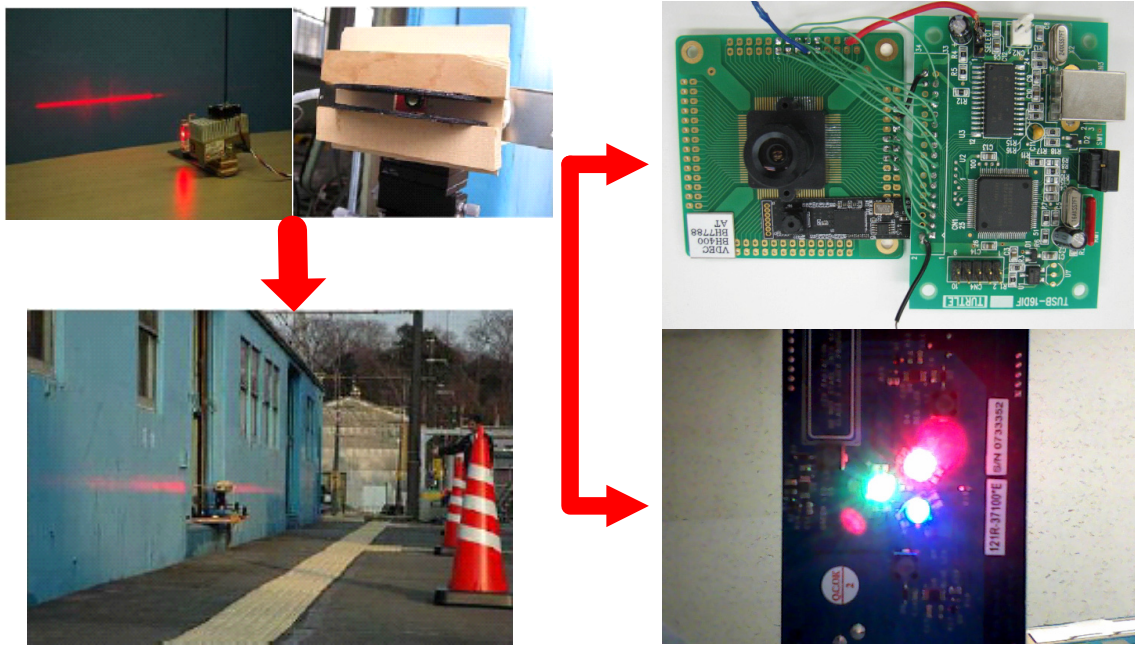

Figure 2-15: Prototypes from Keio University [MHK08] [KHNS07]

they proposed a photogrammetric system based on the concept of visible light communication and the method for extraction of a light and its ID from a variety of a distance [UYS⁺08]. The bottleneck to the practical use is the process time of the images which can take up to 4 minutes for 100 images. The most recent work is a Visible light ID system with integrated CMOS photo-transistor array [MHK08]. The photo-transistor is selected by CCD image and C++ software in order to separate the signals from multiple light sources.

Smart Lighting Engineering Research Center (ERC) of Boston University

Founded in 2008, three universities, Boston University, Rensselaer Polytechnic Institute and University of New Mexico, have been collaborating on the smart lighting technologies. Its researches cover from communication to illumination, semiconductor material to sensing device. Several prototypes have been developed to fit the needs under different scenarios.

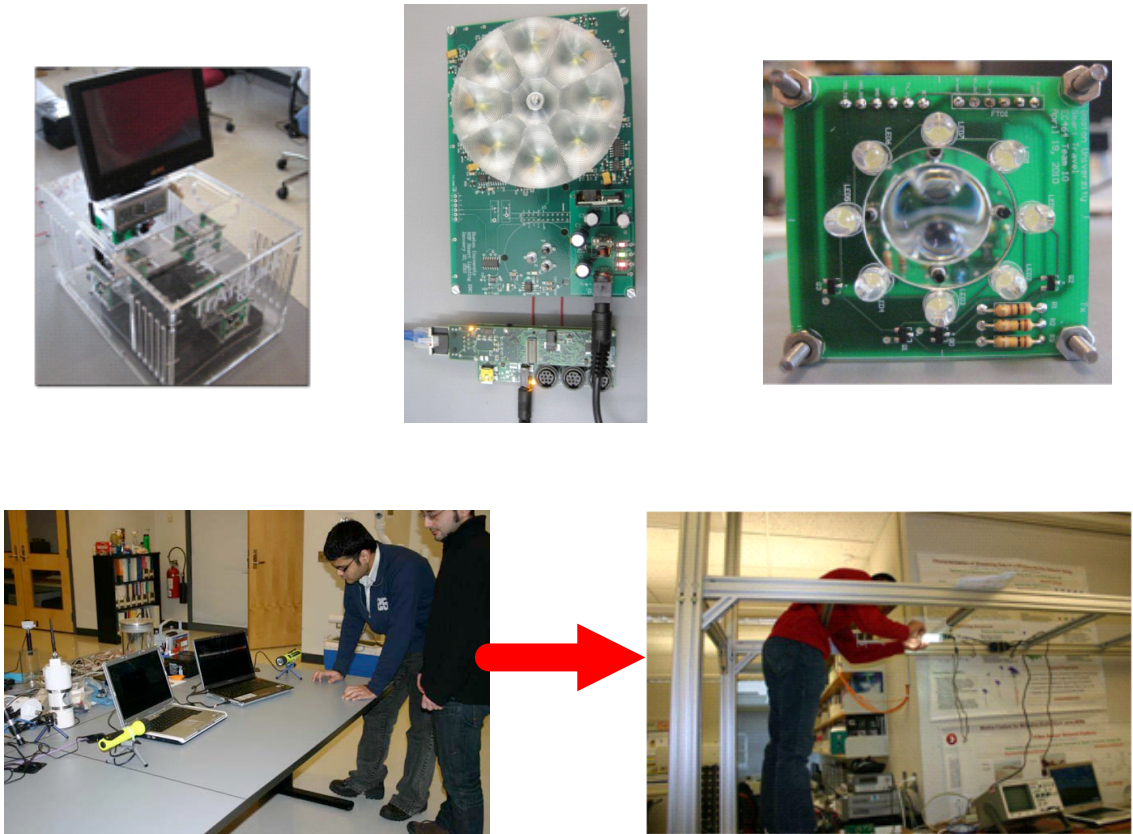

Figure 2.16: Prototypes from Boston University [LDS⁺08] [WCL11]

Little et al. at Boston University demonstrated a short range (3 m) duplex point-to-point white-LED system with the rate of 56 kb/s [LDS⁺08] developed with readily-available electronics and LEDs, demonstrating the viability, simplicity, and low cost of VLC solutions rather than their upper bound in terms of achievable data rates. The same team created a prototype that delivers in excess of 1 Mb/s while providing both illumination and communication at several meters and has been demonstrated as an array of seven luminaries in the form of overhead spot lighting [CML10]. Other prototype works currently include Vehicle-to-Vehicle VLC and SDR Transceivers.

2.2.2 Other Research Groups

There are several other groups have been or are still active on the VLC region. Here, we briefly introduce some of their works.

Niigata University

Different from other prototypes, fluorescent light communications is another possible way for VLC. Recently, Liu et al. from Niigata University have developed a system [LMKM08] and performed a series of experiments using 22 fluorescent lights and 3 different angular degree sensors for indoor guidance and location detection inside a building. Although the maximum rate is only 9.6 kb/s within 2 m, it can support walking speed and be used as reference for the research using next generation LED lighting.

NTT Corporation

The prototype developed by Douseki is an indoor application for communication within a range of 40 cm deployed as a desktop lamp that consists of 200 white LEDs without batteries [Dou04]. Power is derived from a solar cell which also acts as a photon detector for receiving data. This unique design can support transmission up to 100 kb/s.

University of Hong Kong

Pang et al. constructed a system with visible LEDs for traffic light based communication in 1999 [PKLC02]. This is first LED based VLC system as we know. The group set up a system with 441 red ultra-bright LEDs in the lab over 20 m. The system can achieve a rate at 128 kb/s. The goals are providing audio and digital signals transmission for outdoor applications such as roadside-to-vehicle communications.

Chinese Academy of Science

In mainland China, several universities have launched their projects on VLC. The first presented prototype was designed by Chinese Academy of Science [Y CZ⁺09]. With error check and correction abilities, the system can keep 10^{-7} error bit rate within 2.5 m reach at a rate up to 115200 b/s. Their most recent works have been pushing VLC for mobile phone and home automation. The primary targets are low rate control and tracking applications.

Yonsei University

Yonsei University has developed a VLC system recently [ASWH09]. 49 LEDs are placed to form a 7 by 7 array on the transmitter. 5 Mb/s half duplex visible light wireless optical link based on optical access network over a distance of 40 cm was claimed.

Asian Institute of Technology

Researchers from Asian Institute of Technology and Chulalongkorn University in Thailand developed a low data rate VLC system [SSV⁺10]. 4 by 10 RGB LEDs are used to support transmission rates of 19.2 kb/s to the receiver located directly below the panel, and 4.8 kb/s to the receiver located on the table top 1.4 m horizontally away from the center location.

Intel Labs

Richard Roberts introduced a novel way of using VLC for vehicle safety. An automobile positioning scheme that uses the existing automotive LED lighting to send amplitude modulated ranging tones was presented [RGR10]. By calculating the phase difference of arrival, the system is able to determine the distance difference between transceivers.

University of California, Riverside

Dr. Zhengyuan Xu from University of California, Riverside also introduced their first VLC system in 2010. The system can operate at a maximum horizontal separation of 3.5 m and vertical distance of 1 m with maximum data rate of 115 kb/s [CCXR10].

Entrepreneur Companies

Furthermore, VLC commercial products and services are becoming available from several entrepreneur companies.

LVX System is a managing organization of 55 separate companies that work together to offer a revolutionary lighting technology that provides energy efficient lighting and visible light wireless communication services [LVX].

Talking Lights LLC was founded by Professor Steven Leeb and Dr. E.C. Lupton of the Electrical Engineering and Computer Science Department of the Massachusetts Institute of Technology. Its VLC system aims to achieve GPS-like position identification and guidance indoors, where GPS cannot operate [TAL].

ByteLight provides revolutionary lighting technologies that transform overhead lighting into a platform for sensing, communication and localization. With their LightControl software, LightLocal transceivers and LightView software, facility managers are able to reduce energy cost, pinpoint the location of any device and improve operational efficiency by up to 25 percent [BYT].

Chapter 3

Modeling and Signaling of Indoor VLC

In this chapter, we present our research on signaling issues of indoor VLC. Two sections are included. In the first section, we start with modeling VLC system in a room assumed to serve as an office, and the main purpose of the lighting is to illuminate a desk located at the center of the room as illustrated in Figure 3-1. Although the results are derived based on set of parameters of our VLC prototype, the approach can be adopted to any indoor VLC systems. The purpose is to provide a novel overview for indoor VLC in terms of performances, such as signal attenuation, BER, SNR and rate.

Furthermore, in the second section, a general discussion on DMT (baseband OFDM) is also presented for the reason that it can achieve better bandwidth efficiency. The analysis reveals directions about how we can improve the indoor VLC system in terms of better throughput.

3.1 Framework for Indoor Scenarios

3.1.1 Room Geometry

Before the discussion of the performance analysis, we first introduce the geometry of the office room and also the characteristics of LEDs. In order to make the results of our investigation comparable to those used in the others' studies, we consider a general indoor scenario, an empty room with identical dimensions. We set the size to a $12 \times 12 \times 3\text{m}^3$ cube. In this model, the receiver is assumed to be placed at 1

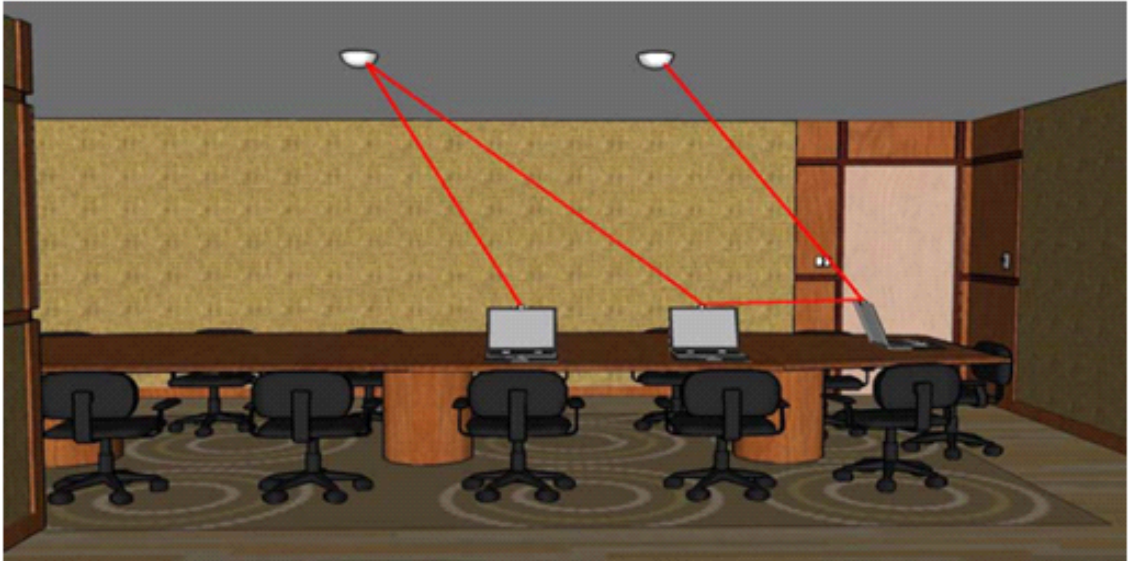

Figure 3.1: An illustration of VLC system

m desktop level. There are four transmitters locating at the ceiling level with the horizontal coordinates, (3,3), (3,9), (9,3) and (9,9). Each transmitter is equipped with eight LEDs to give enough brightness for the room. The model can be illustrated in Figure 3.2.

A basic transmit rate of 10 Mb/s with a distance up to 3 m is achievable from access point to user device. From the access point, the total speed can be satisfied is 10 Mb/s/m³. When multiple access is supported, the speed of downlink per user can be up to 1 Mb/s under the satisfaction of the total rate requirement. The device on the user side should be able to support mobility without sacrificing this performance, and also rate up to 10 Mb/s between user devices through our quasi-point-to-point link model. Routing service should be available when blocking of service occurs. MAC scheme should be available to provide both smoothly switch between different access points and contention free (or reduce to accept level) within one single access point.

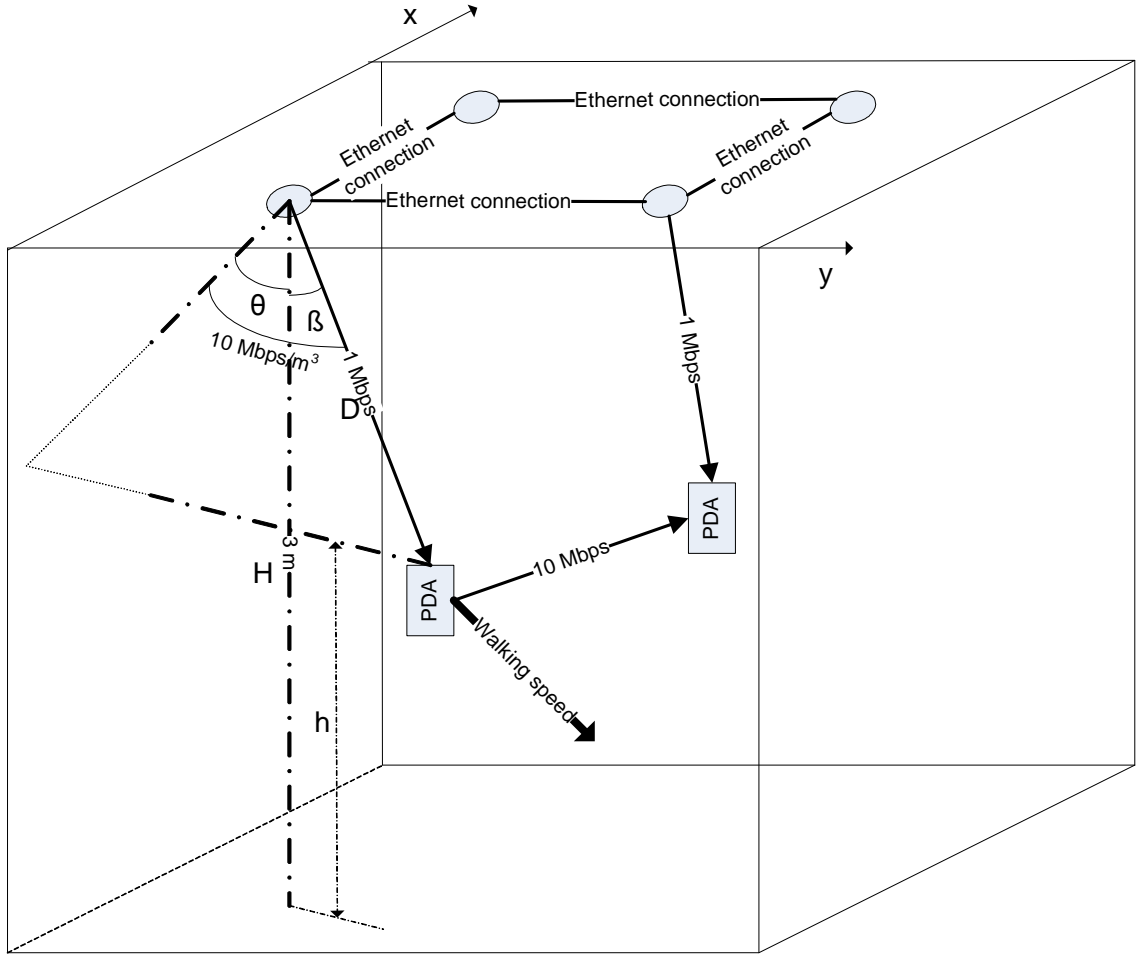

Figure 3-2: Proposed FSO system model for indoor applications

3.1.2 Optical Power Analysis of LED Transmitter

Integrated in our prototype, an LXML-PWC1-0040 LED [LED] can provide 220 lm. That means from each transmitter, there is 1760 lm luminous flux emitted. Therefore, with four transmitters above, as described in Section 2.2.1, luminous emittance, M_v , is estimated at 200-800 lx in the whole room.

Even though white light can be a proper mixing of red, green and blue light, at present most devices for illumination use a blue LED which illuminates a layer of yellow phosphor, with these two colors mixing to create a white emission. The optical

power P_t of such LED is normally obtained from radiation spectrum $S_t(\lambda)$ by

$$P_t = \int_{\lambda_L}^{\lambda_H} S_t(\lambda) d\lambda.$$

However, typically most of manufacturers only give the normalized radiation spectrum $S'_t(\lambda)$ as displayed in Figure 3-3. If we denote a scaling factor $c_t = S_t(\lambda)/S'_t(\lambda)$, it can be found from [Sch06]

$$c_t = \frac{F_t}{683 \int_{380nm}^{780nm} S'_t(\lambda) V(\lambda) d\lambda},$$

where F_t is total luminous flux and $V(\lambda)$, the eye sensitivity function, can be approximated by the following Gaussian curve fitting [PG09]

$$V(\lambda) \cong 1.019e^{-285.4(\lambda-0.559)^2}.$$

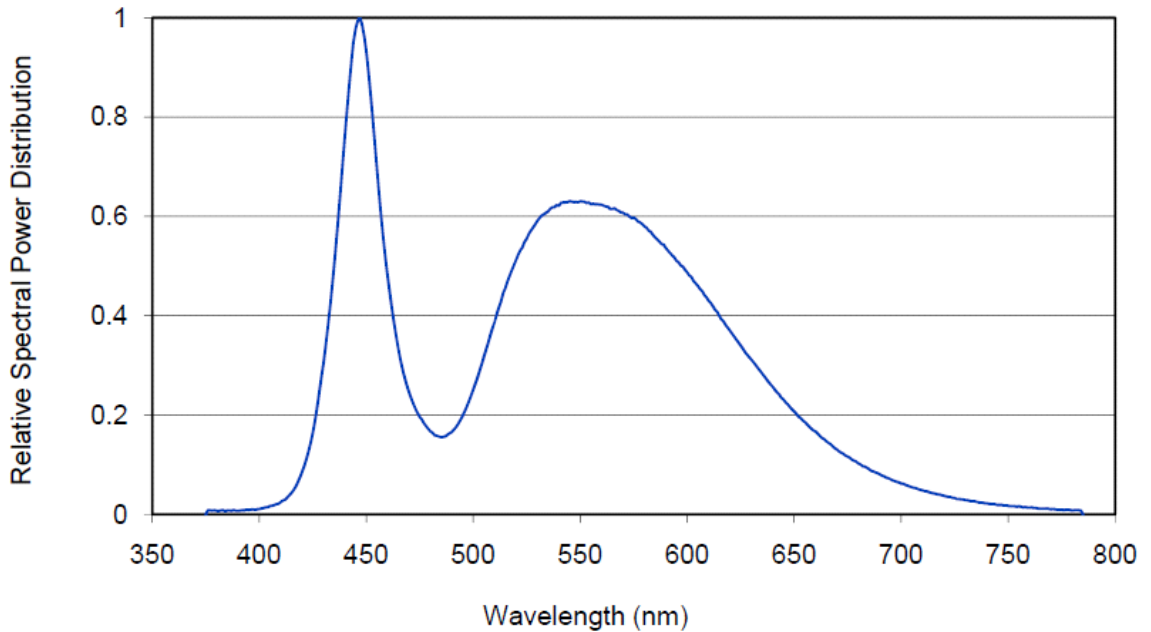

Figure 3-3: Radiation spectrum of LXML-PWC1-0040 [LED]

In this way, we are able to have the actual optical transmit power instead of the power consumed by the whole transmitter from which little useful information can be derived for communication, and in our system, it is 0.18 mW.

Most white LEDs have low modulation bandwidth of several MHz due to the long response time of the yellow phosphor. By suppressing the slow portion in the spectrum with the method of blue filtering, the modulation bandwidth can be enhanced to 20 – 25 MHz [GLL⁺07]. Therefore, only about 50% of the total optical power is received. In the Section 3.2, we will discuss tradeoff between optical power received and modulation bandwidth by analyzing the performance with and without blue filtering.

3.1.3 LED and Photodiode Parameters

In the model proposed in Figure 3.2, not only is sufficient optical power needed for a reliable high-speed data transmission, a certain brightness of the illuminated surface is also required for proper lighting. In order to align with the prototypes in our MCL, We choose LXML-PWC1-0040 [LED] and SFH 213 [Pho] respectively for transmitter and receiver.

Table 3.1: Summary of chip parameters and room setup [LED] [Pho]

LED Parameters	
Half radiation angle (θ_{max})	60°
Luminous flux (F)	220 lm
Optical transmit power (P_t)	0.18 mW (without blue filtering)
	0.09 mW (with blue filtering)
Modulation bandwidth (B)	2 MHz (without blue filtering)
	20 MHz (with blue filtering)
Photodiode Parameters	
Photodiode responsivity	0.62 A/W
Receiver area	1 mm ²
Other Parameters	
Room size	12×12×3 m ³
Device height	1 m
Chips on transmitter	8
Locations of transmitters	(3,3),(3,9),(9,3),(9,9)

3.2 Channel Signal Attenuation Model

In this section, a general LOS channel model is considered. Evaluation of signal attenuation and other three characteristics are derived based on the photometric parameters we introduce in the Section 3.1.3. The results we obtain here can provide certain insight and guidance for indoor VLC systems.

3.2.1 Signal Attenuation

The channel model we adopt is from [RX09]. It only considers LOS links. The diffuse link model is shown as Figure 3-4. Based on it, we evaluate the corresponding signal attenuation that is used for the other communication performance study later. The notations are defined in Table 3.2.

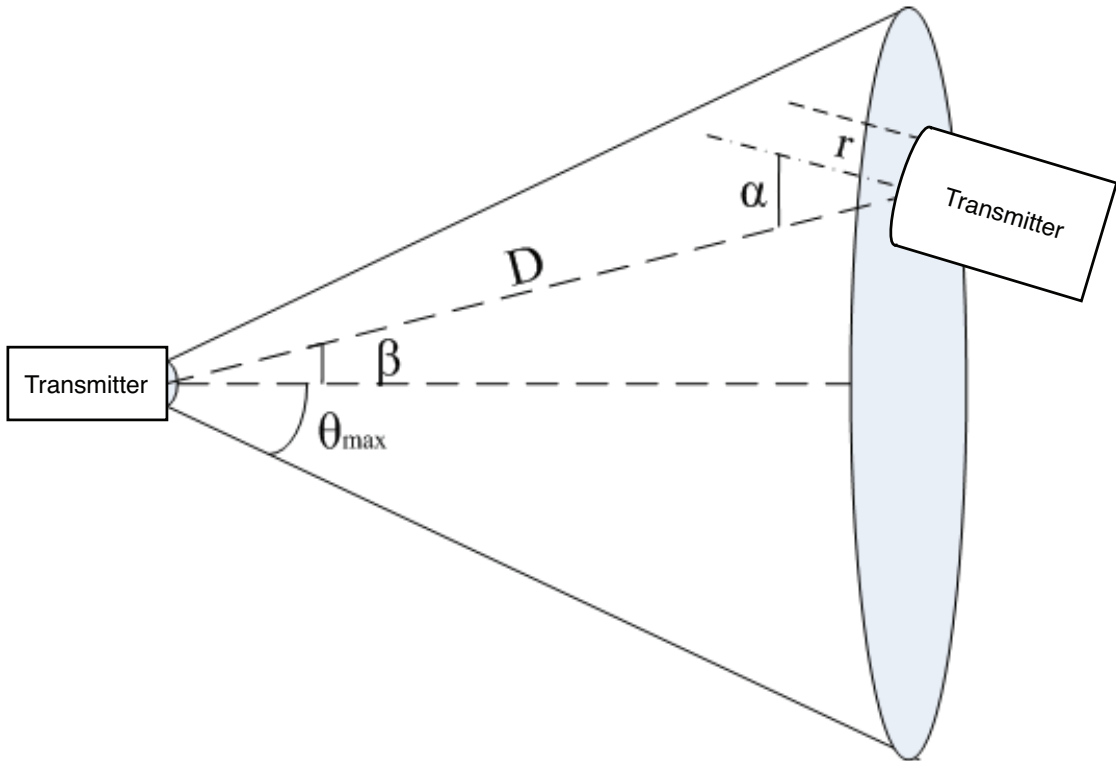

Figure 3-4: LOS diffuse link model for signal attenuation [RX09]

Table 3.2: Parameter definition for LOS diffuse link model

Parameter	Definition
D	Distance from receiver to source
r	Receiver aperture radius
α	Angle from source-receiver line to receiver axis
β	Angle from source-receiver line to source axis
I_0	Axial intensity with unit candela
$g_t(\theta)$	Normalized spatial radiation pattern

We assume the transmitter LED has the spatial luminous intensity distribution $I_0 g_t(\theta)$, where I_0 is the axial intensity with unit candela and $g_t(\theta)$ is the normalized spatial radiation pattern provided by [LED]. Therefore, the total transmitted luminous flux of the transmitter LED is

$$\begin{aligned} F_s &= \int_0^{\Omega_{max}} I_0 g_t(\theta) d\Omega \\ &= I_0 \int_0^{\theta_{max}} 2\pi g_t(\theta) \sin\theta d\theta, \end{aligned}$$

where Ω_{max} is the LED beam solid angle, which is related to the LED half radiation angle θ_{max} as

$$\Omega_{max} = 2\pi(1 - \cos\theta_{max}).$$

Therefore, [RX09], the signal attenuation performance can be calculated by

$$\begin{aligned} L &= \frac{F_r}{F_s} \\ &= \frac{I_0 g_t(\beta) \Omega_r}{I_0 \int_0^{\theta_{max}} 2\pi g_t(\theta) \sin\theta d\theta} \\ &\approx \frac{g_t(\beta) A_r}{D^2 \int_0^{\theta_{max}} 2\pi g_t(\theta) \sin\theta d\theta}, \end{aligned}$$

in which A_r donates receiver area, $g_t(\cdot)$ and θ_{max} are given in [LED], and α is considered

as zero for simplicity, which means the receiver is always pointing vertically to the ceiling.

Another note is that the received optical power is the summation of optical power from all LED chips in the room, instead of one single LED in the formula.

3.2.2 SNR

In FSO, the noise can consist of several types of noise sources, such as fluorescent light interference, thermal noise and photon-generated shot noise. Shot noise, stemming from ambient light, is a major noise source in the wireless optical communications. From [KB97], conservatively, the noise power spectral density is

$$N_0 \cong N_{shot} = 2q\gamma P_n \sim 10^{-22} \text{A}^2/\text{Hz},$$

where q is the electronic charge, γ is the responsivity and P_n is the average power of ambient light.

Therefore, for certain bit rate of R_b we can have the receiver electrical SNR defined in [KB97] for any spot in the room,

$$\text{SNR} = \frac{\gamma^2 P_r^2}{R_b N_0}.$$

3.2.3 Upper Bound of the Rate

Another important measure of performance is throughput. Although the actual achievable rate depends on several parameters, the rate upper bound from Shannon theorem can still give certain evaluation of performance.

Considering all possible multi-level and multi-phase encoding techniques, the Shannon theorem states that the channel capacity C , meaning the theoretical tightest upper bound on the information rate (excluding error correcting codes) that can be

sent with a given SNR, is

$$C = B \log_2(1 + \text{SNR}).$$

3.2.4 BER

The performance of BER is related to the coding and modulation techniques. In this prototype we adopt OOK for its simplicity and power efficiency [Hra04]. It is a binary level modulation scheme consisting of two symbols. Assuming that ones and zeros are equally likely, therefore, the BER can be determined from [Hra04] as

$$P_e = Q\left(\frac{P}{\sqrt{R_b N_0}}\right) = Q(\sqrt{\text{SNR}}).$$

3.2.5 Performance Analysis

We first calculate four parameters without any blue filtering, and have the modulation bandwidth 2 MHz. The results show in Figure 3-5. The signal attenuation and SNR are in Decibel (dB), maximum rate is in Mb/s and BER is in power of 10.

	Max	Min
Signal Attenuation	-70.86 dB	-85.37 dB
SNR	14.29 dB	-14.73 dB
Rate	10.00 Mb/s	0.10 Mb/s
BER	0.43	$1.11 \cdot 10^{-7}$

Table 3.3: Performance results without blue filtering

Next, if blue filtering is adopted, the optical transmit power will be reduced to approximately half, which is 0.09 mW. By only having the fast response portion and better signal shape, it is possible to enhance the modulation bandwidth to 20 MHz. The results show in Figure 3-6.

The results demonstrate that even for short range LOS link, VLC still suffers from high signal attenuation. However, with the assumption of indoor FSO, low Gaussian

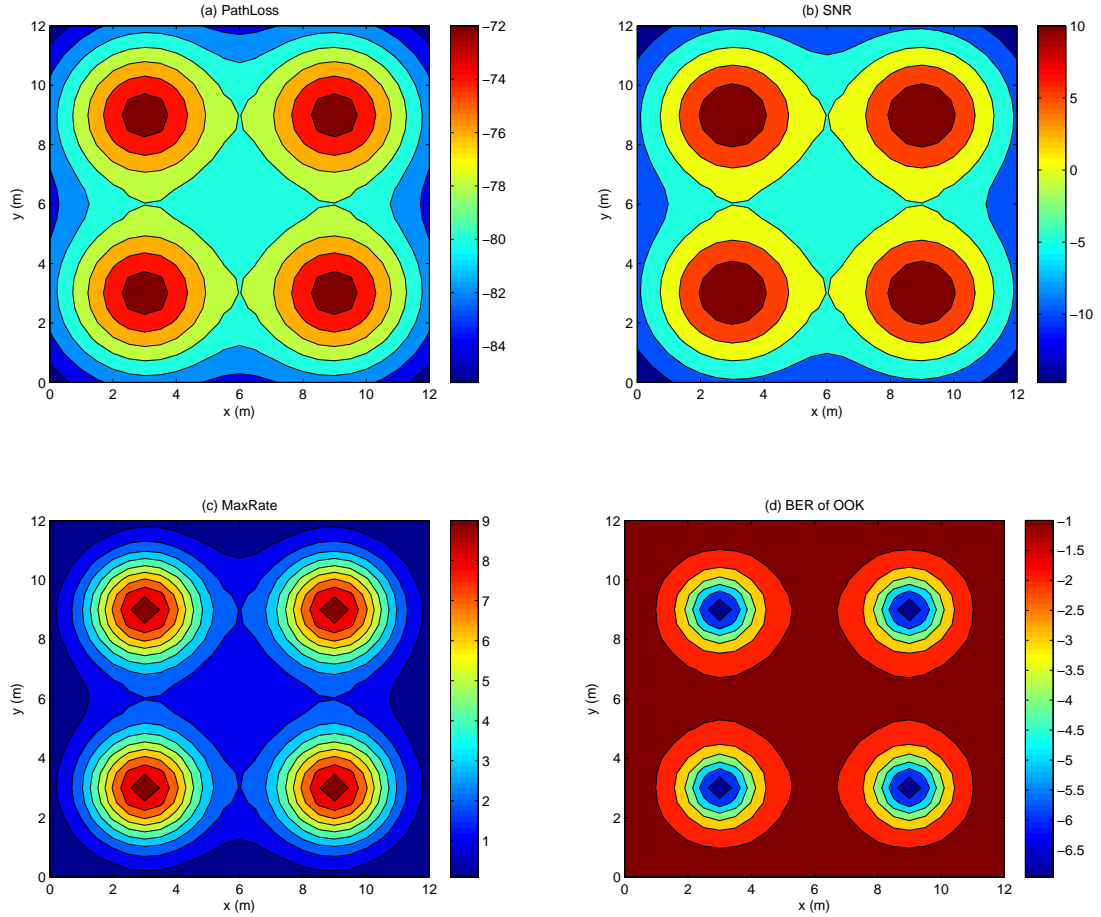

Figure 3-5: Signal Attenuation (a), SNR (b), Max Rate (c) and BER (d) of the prototype system without blue filtering

noise will be considered, and therefore, the results also reveal the fact that the SNR and BER (without error correction coding) of OOK modulation are acceptable for low data rate ($< \text{Mb/s}$) communications.

At the other hand, by adopting blue filtering, it is possible to enhance the chip's modulation bandwidth to as high as 10 times of the previous performance. But the improvement of the data rate also increases the shot noise variance that eventually leads to the degradation of SNR and BER. So, under same setup (illuminance, optical power and etc.), simply increasing the modulation bandwidth with blue filtering

	Max	Min
Signal Attenuation	-70.86 dB	-85.37 dB
SNR	-1.73 dB	-30.75 dB
Rate	14.81 Mb/s	0.024 Mb/s
BER	0.49	0.21

Table 3.4: Performance results with blue filtering

cannot significantly improve the whole performance. Better modulation and coding techniques are required with it.

3.2.6 New VLC Prototype

Many types of optical transceivers exist; some are designed to send light through wave guides, such as fiber-optics, and others, like the transceiver demonstrated, are FSO transceivers that are able to transmit and receive data without the aid of a waveguide. Unlike most FSO transceiver though, the demonstrated transceiver generates and modulates “white” light in the visible spectrum. This feature allows the transceiver to be used in lieu of regular lighting devices, allowing this versatile and controllable lighting to replace conventional lighting.

One of the most important components of the transceivers is customized LED driver. Since the content of this dissertation is focusing on the architecture other than device, a brief introduction of our prototype is given here to demonstrate some practical performance such as rate.

It consists of two parts. The first part was designed to switch current toward and away from the LED; when the LED should be off, current is switched away from it to discharge any capacitance across the LED. The other part was designed to maintain the desired current through the LED when it is supposed to be on.

Shown in Figure 3-7 is the transceiver transmitting data. The LED driver is in the top half of the photograph, lighting the white LEDs under a lens.

The performance of the transceiver at 2 Mb/s is shown in Figure 3-8, with the

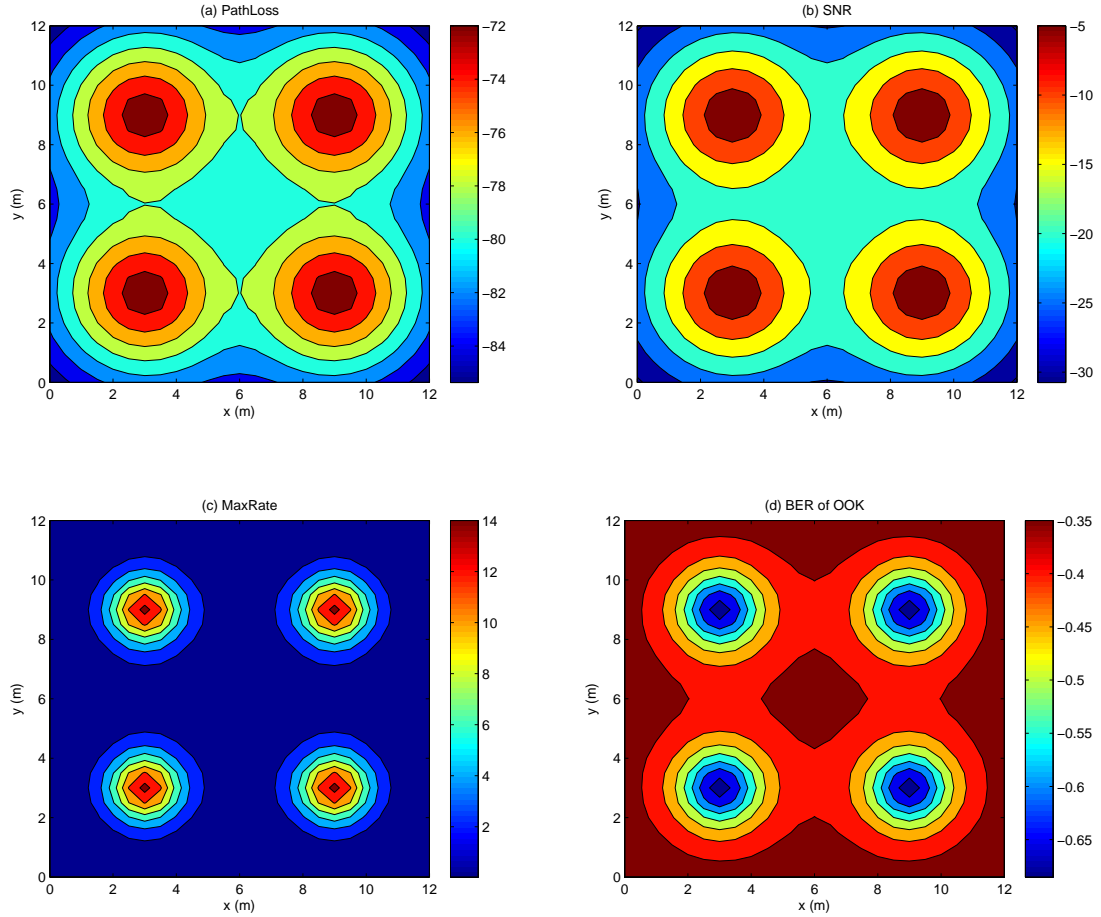

Figure 3-6: Signal Attenuation (a), SNR (b), Max Rate (c) and BER (d) of the prototype system with blue filtering

transmitter input as the yellow signal and the receiver output as the green signal in the oscilloscope. The left half shows the operation when the transceiver is idle with the LEDs on and the right half shows data transmission.

3.3 DMT Analysis

Another important issue is the signaling design to improve the diffuse link model performance. As we know, the main distortion that affects the channel is due to

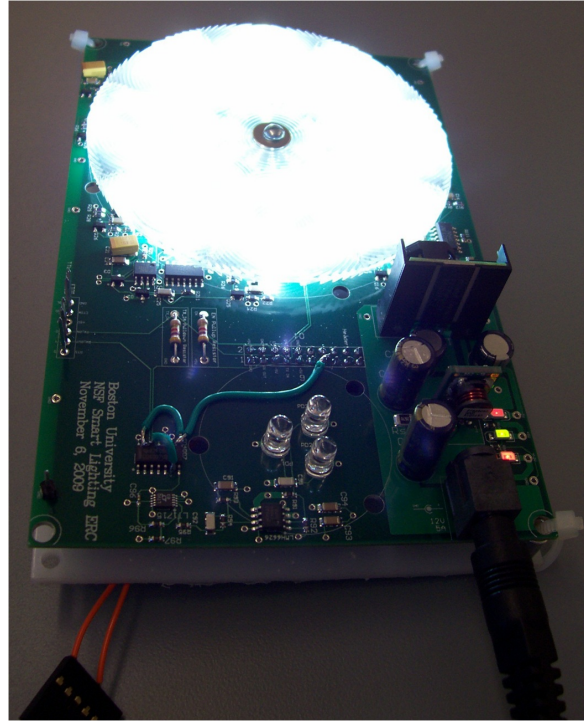

Figure 3-7: Current VLC prototype for indoor applications [WCL11]

multiple copies from different paths, which is called multipath distortion. One of the most efficient solutions is OFDM.

In OFDM, a large number of closely-spaced orthogonal sub-carriers are used to carry data. The data is divided into several parallel data streams or channels, one for each sub-carrier. Each sub-carrier is modulated with a conventional modulation scheme at a low symbol rate, maintaining total data rates similar to conventional single-carrier modulation schemes in the same bandwidth. Since it can mitigate ISI arose by multipath distortion without complex equalization filter, OFDM is a good solution for the multipath distortion in wireless optical communication, especially for the indoor applications.

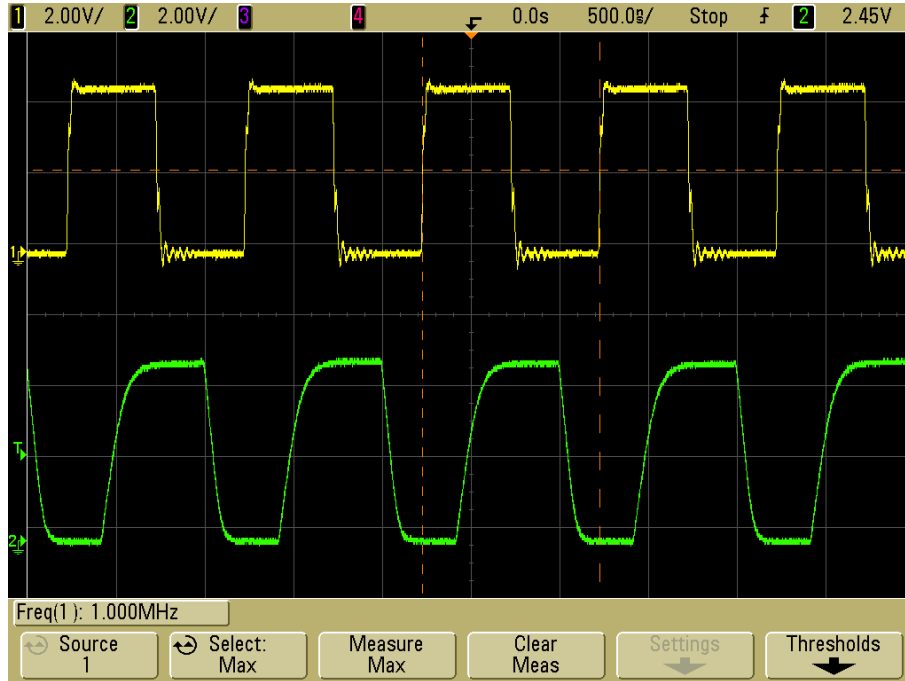

Figure 3-8: Waveforms of transmit and receive signals [WCL11]

The discussion of this topic is started from Multiple-Subcarrier Modulation (MSM) in [CK96]. Later, in [AL06] and [GPJR⁺05], researchers extended such topic for wireless optical communication with adaptive design and corresponding performance analysis.

Besides power inefficiency, another problem of OFDM in optical system is the signal has to be non-negative. In [AL06], research has been proposed to solve it and increase the power efficiency by using single sideband modulation. It claimed that the optical power efficiency is approximately 8 dB better than previously described optical OFDM systems. However, currently there is no prototype designed based on such technique.

Another consideration is if we use carrier as OFDM does in RF communication, the rate will be limited because carrier is required to be much higher than the actual signal. Therefore, DMT, which is baseband OFDM, becomes a more popular

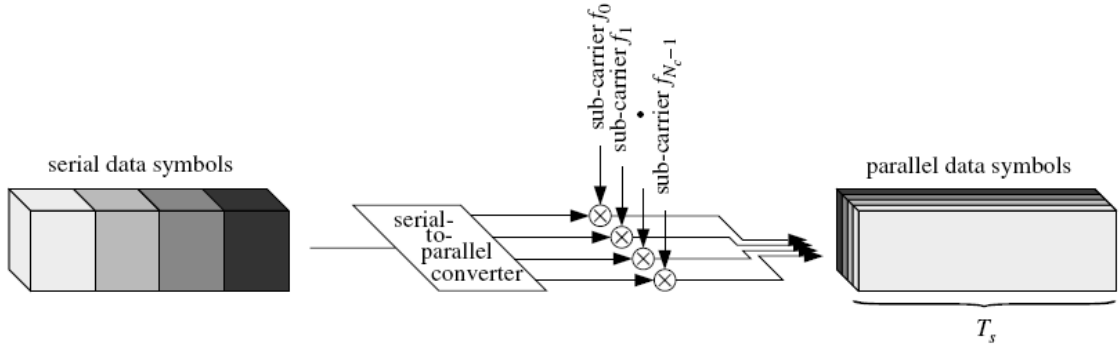

Figure 3-9: Orthogonal Frequency Division Multiplexing [FK03]

candidate for FSO systems, and several prototypes have been demonstrated in Section 2.2.1.

In this section, we give some fundamental researches on DMT to show in which ways it can improve the VLC.

3.3.1 BER

BER is one of the most important parameters to measure. There are three general types of interference. multipath distortion, negative signal chopping distortion and ambient light shot noise. Since we consider AWGN model based on FSO without any feedback loop, we assume a channel with Finite Impulse Response (FIR) as

$$y[k] = x[k] + 0.6x[k - 1] - 0.4x[k - 2] + 0.2x[k - 3] - 0.1x[k - 4] + 0.02x[k - 5] \quad (3.1)$$

By using DMT, A high-speed binary serial input data sequence is divided into N parallel lower-speed binary streams. For each stream indexed by n , where $n = 0, 1, \dots, N - 1$, every M number of bits are grouped together and mapped onto complex values C_n according to a QAM constellation. Usually, a $2N$ -point Inverse Fast Fourier Transform (IFFT) is used in the DMT transmitter to efficiently modulate C_n into real value sequence onto N different channels. Therefore, the symbol after

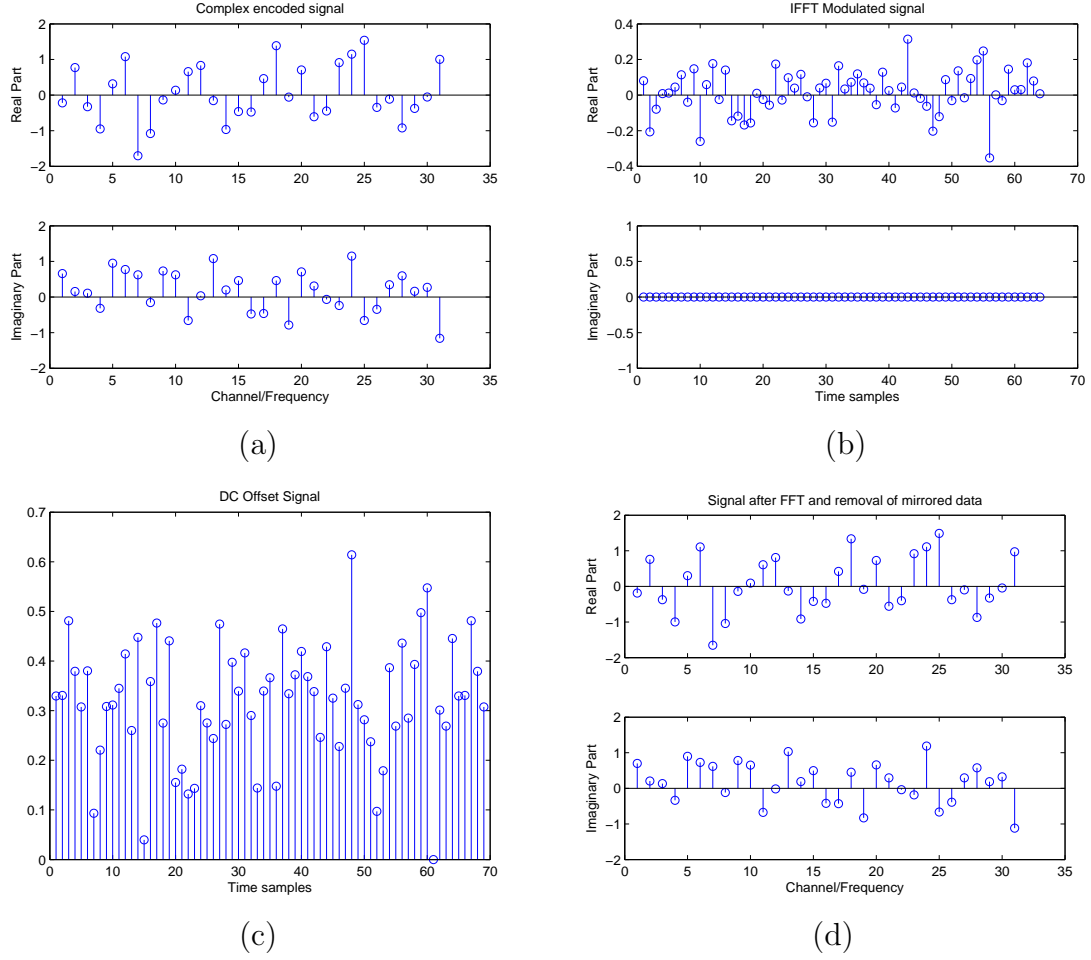

Figure 3-10: (a) Encoded signal after QAM (b) Modulated signal after IFFT (c) DC-offset signal before transmitting (d) Received signal after FFT recovery

IFFT can be denoted as

$$u[k] = \frac{1}{\sqrt{2N}} \sum_{n=0}^{2N-1} C_n e^{j2\pi n \frac{k}{2N}}, k = 0, 1, \dots, 2N - 1. \quad (3.2)$$

If we further take DC bias and prefix into consideration, the output of transmitter will be

$$x[k] = \frac{1}{\sqrt{2N}} \sum_{n=0}^{2N-1} C_n e^{j2\pi n \frac{k-N_p}{2N}} + D, k = 0, 1, \dots, 2N - 1 + N_p, \quad (3.3)$$

where N_p denotes prefix length and D denotes the DC bias to avoid distortion by cutting off the negative signal.

Similarly, at the receiver side, we shift the received symbol, $y[k]$, back to zero bias and then strip out the prefix. The symbol after FFT will be

$$\hat{C}_n = \sum_{k=N_p}^{2N-1+N_p} y[k] e^{-j2\pi n \frac{k-N_p}{2N}}, n = 0, 1, \dots, 2N - 1. \quad (3.4)$$

We demonstrate the process in a one-time DMT simulation which shown in Figure 3-10. In this simulation, 64 channels are assigned. 16 bits data are generated randomly without particular bit loading scheme. Prefix length is five which can just cover the all multi paths. QAM is used on each channel. It also shows in Figure 3-10(b) that the DMT modulated signal actually has zero imaginary part. Due to the facts of no imaginary part and baseband modulation, high-frequency, analog RF-components required for in-phase and quadrature-phase modulation are omitted from DMT transceivers, reducing system costs and complexity.

Based on (3.1), (3.3) and (3.4), we demonstrate BER performance of DMT and OOK in a multi-iteration simulation based on same parameters in the previous one-time DMT simulation. In the simulation, three different DC offsets are considered to overcome negative signal chopping distortion. The reason we choose DC offset solution is we are combining communication functionality with illumination functionality, so the DC offset is inevitable to provide enough brightness to the entire room. In Figure 3-10(c), we demonstrate the signaling process of DC-offset DMT solution. The signal is chopped and reconstructed between transceivers, resulting in a few errors.

From Figure 3-11, although OOK can provide better result for small SNR, after 25 dB SNR, OOK can't improve the BER into an acceptable level alone because of the ISI from the multipath distortion. On the other hand, DMT is more vulnerable to the noise. This is because instead of two level signal of OOK, multi-level signal

schemes have shorter minimum distance, and each symbol contains information of multiple bits that one error symbol can result more than one errors in the original signal. However, when SNR is higher enough, in this case it is 50 dB, DMT can continue improve the BER performance.

Therefore, theoretically, by choosing great enough DC offset and long enough prefix, BER of DMT can approach zero with the increase of SNR. From Section 2.1.4, with a good signal filter at receiver side, good SNR is achievable by filtering out the ambient noise.

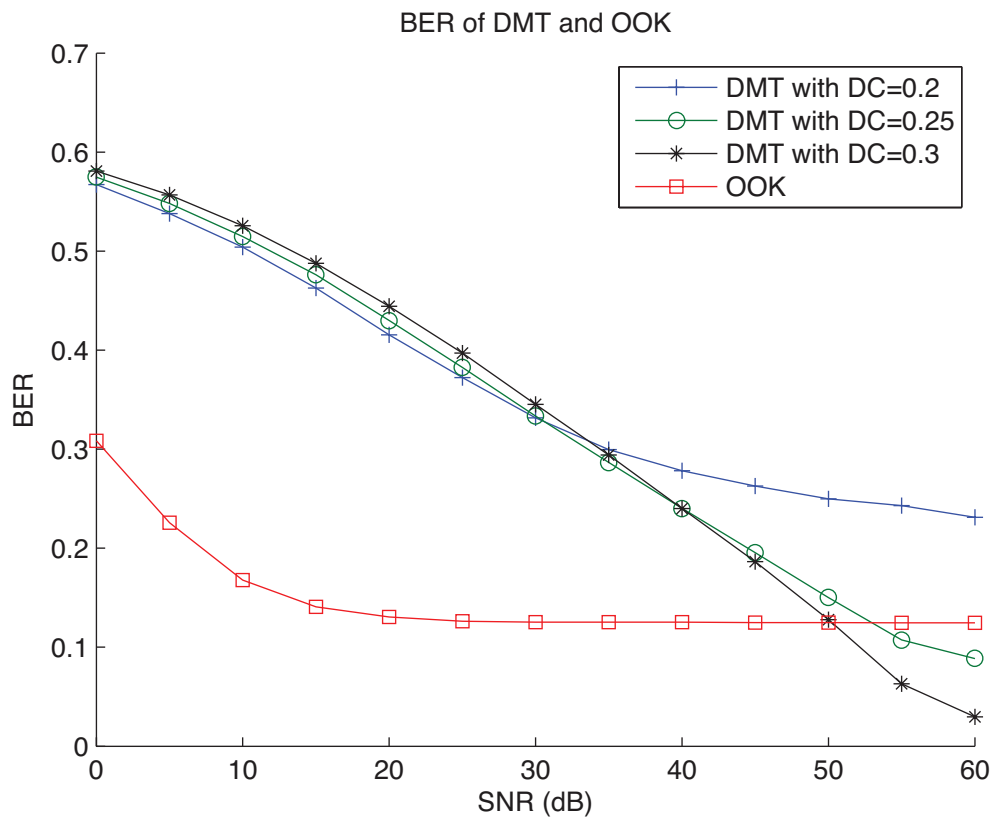

Figure 3-11: BER performance among different modulation schemes

3.3.2 Channel Capacity

Secondly, we give numerical results to show that DMT can indeed improve the channel. We here consider a simple in-door scenario with LOS link.

As is the case in RF transmission systems, multipath propagation effects are important for wireless optical networks. However, there are some differences.

First, multipath fading is not a major impairment in wireless optical transmission. This is mainly because the large size of the detector with respect to the wavelength of the light provides a degree of inherent spatial diversity in the receiver which mitigates the impact of multipath fading.

The second concern is the temporal dispersion of the received signal due to multipath propagation (mostly referred as multipath distortion). This distortion is often modeled as a linear time invariant system since the channel properties change slowly over many symbol periods [KKC95]. Indeed, channel models proposed for LOS links assume the LOS path dominates and model the channel as a linear attenuation and delay [CK97]. Furthermore, as a matter of fact, in a scenario with many LOS links (as a typical office with multiple LED-based lamps), multipath distortion is seldom an issue [Hra04] and the channel can be considered flat over the bandwidth of interest [Hra04] [GRLW08b] [LGB⁺08] [VKN⁺09a].

Therefore, in the following analysis under the assumption of in-door LOS links, without loss of generality, we consider $h(t) = 1$, which makes the channel into

$$y(t) = x(t) + n(t).$$

From information theory, we know that the channel capacity is given by mutual

information which is

$$\begin{aligned} I(x, y) &= H(y) - H(n) \\ &= - \int_{-\infty}^{\infty} f_y(y) \log_2 f_y(y) dy - 0.5 \log_2 4\pi\sigma_n^2, \end{aligned} \quad (3.5)$$

where $H()$ denotes the entropy of corresponding signal and $f_y(y)$ is the Probability Density Function (pdf) of the received signal samples. So, channel capacity depends on the distribution of received signal, which is determined by the input signal. To simplify the calculation, we set the constraint on average power of input optical signal to 1,

$$P = \int_0^{\infty} x f_x(x) dx \leq 1.$$

We have four candidates here for comparison. The first one is using OOK as modulation scheme. The second one is using DMT without DC offset [AL06], the third one is using DMT with 0.5 DC, and last one is the distribution which can achieve maximum channel capacity. From Shannon's theorem, when the constraint is on the square of signal amplitude, the maximum channel capacity is achieved by Gaussian input. So, from the relation between Gaussian distribution and exponential distribution, the maximum channel capacity for optical channel should be achieved by exponential input.

OOK

OOK is the simplest case among four schemes. If we consider 0, d with same probability in the data, then from power constraint, $0 \times \frac{1}{2} + d \times \frac{1}{2} = 1$, which gives $d = 2$

for OOK. Therefore $f_y(y)$ of OOK is

$$\begin{aligned} f_y(y) &= \frac{1}{2}(N(0, \sigma_n^2) + N(2, \sigma_n^2)) \\ &= \frac{1}{\sqrt{8\pi}\sigma_n} \left(e^{-\frac{y^2}{2\sigma_n^2}} + e^{-\frac{(y-2)^2}{2\sigma_n^2}} \right). \end{aligned} \quad (3.6)$$

DMT without DC

DMT is much more complicated than OOK scheme. In the traditional OFDM system, the data to be transmitted is mapped onto a complex vector of length N , and then the OFDM signal is generated by using N point IFFT. Based on the central limit theorem, if N is large enough, the outputs of the IFFT should have a Gaussian distribution. However, in a FSO system with IM/DD, the signal must satisfy non-negative that the transmitter will simply clip all the negative signals at 0. After that, the signal distribution can be considered as 0 for half probability and Gaussian distribution for the other half. From power constraint,

$$\begin{aligned} E(x) &= \int_0^{\infty} x f_x(x) dx \\ &= \int_0^{\infty} x \frac{1}{\sqrt{2\pi}\sigma} e^{-\frac{x^2}{2\sigma^2}} dx \\ &= 1, \end{aligned}$$

we have $\sigma = \sqrt{2\pi}$.

In this way, the distribution of summation of signal and noise at receiver will be

the convolution of them, which is

$$\begin{aligned}
f_y(y) &= \frac{1}{2}(f_n(y) + \int_0^\infty f_x(x)f_n(y-x)dx) \\
&= \frac{1}{\sqrt{8\pi}\sigma_n}e^{-\frac{y^2}{2\sigma_n^2}} + \frac{1}{4\pi\sqrt{2\pi}\sigma_n} \int_0^\infty e^{-\frac{x^2}{4\pi} - \frac{(y-x)^2}{2\sigma_n^2}} dx \\
&= \frac{1}{\sqrt{8\pi}\sigma_n}e^{-\frac{y^2}{2\sigma_n^2}} + \frac{1}{\sqrt{8\pi(\sigma_n^2 + 2\pi)}}e^{-\frac{y^2}{4\pi+2\sigma_n^2}} \operatorname{erfc}\left(-\sqrt{\frac{\pi}{\sigma_n^2(2\pi + \sigma_n^2)}}\right), \quad (3.7)
\end{aligned}$$

where $\operatorname{erfc}()$ is complementary error function that equals to $\frac{2}{\sqrt{\pi}} \int_x^\infty e^{-t^2} dt$.

DMT with DC

The third candidate is adding DC offset to make fewer signals being clipped that less distortion will give to the receiver. Here we give a 0.5 offset. Then from

$$\begin{aligned}
E(x) &= \int_0^\infty x f_x(x) dx \\
&= \int_0^\infty x \frac{1}{\sqrt{2\pi}\sigma} e^{-\frac{(x-0.5)^2}{2\sigma^2}} dx \\
&= 1,
\end{aligned}$$

we have $\sigma = 1$. Furthermore, we need to notice that

$$P(x = 0) = \int_{-\infty}^0 f(x) dx = 0.3085.$$

Let $p = 0.3085$. The received signal distribution will be

$$\begin{aligned}
f_y(y) &= pf_n(y) + (1-p) \int_0^{\infty} f_x(x)f_n(y-x)dx \\
&= \frac{p}{\sqrt{2\pi}\sigma_n} e^{-\frac{y^2}{2\sigma_n^2}} + \frac{1-p}{2\pi\sigma_n} \int_0^{\infty} e^{-\frac{(x-0.5)^2}{2} - \frac{(y-x)^2}{2\sigma_n^2}} dx \\
&= \frac{p}{\sqrt{2\pi}\sigma_n} e^{-\frac{y^2}{2\sigma_n^2}} + \frac{1-p}{\sqrt{8\pi(\sigma_n^2+1)}} e^{-\frac{(y-0.5)^2}{2+2\sigma_n^2}} \operatorname{erfc}\left(-\frac{y+0.5\sigma_n^2}{\sigma_n\sqrt{2+2\sigma_n^2}}\right). \quad (3.8)
\end{aligned}$$

Exponential Distribution

For the last case, when the input follows exponential distribution,

$$\begin{aligned}
E(x) &= \int_0^{\infty} x f_x(x) dx \\
&= \int_0^{\infty} x \frac{1}{a} e^{-x/a} dx \\
&= 1,
\end{aligned}$$

which gives $a = 1$.

Therefore the received signal distribution will be

$$\begin{aligned}
f_y(y) &= \int_0^{\infty} f_x(x)f_n(y-x)dx \\
&= \int_0^{\infty} \frac{1}{\sqrt{2\pi}\sigma_n} e^{-x - \frac{(y-x)^2}{2\sigma_n^2}} dx \\
&= \frac{e^{-y+\sigma_n^2/2}}{2} \operatorname{erfc}\left(\frac{-y+\sigma_n^2}{\sqrt{2}\sigma_n}\right). \quad (3.9)
\end{aligned}$$

From the property of Gaussian noise, we have

$$\sigma_n^2 = 10^{-\frac{SNR}{10}}. \quad (3.10)$$

Putting back (3.6), (3.7), (3.8), (3.9) and (3.10) to (3.5), we therefore are able to obtain channel capacities of these four cases with the computation of MATLAB. Different from the simulation analysis in Section 3.3.1, the analysis here is theoretical derivation. Figure 3-12 demonstrates the results in terms of different SNR.

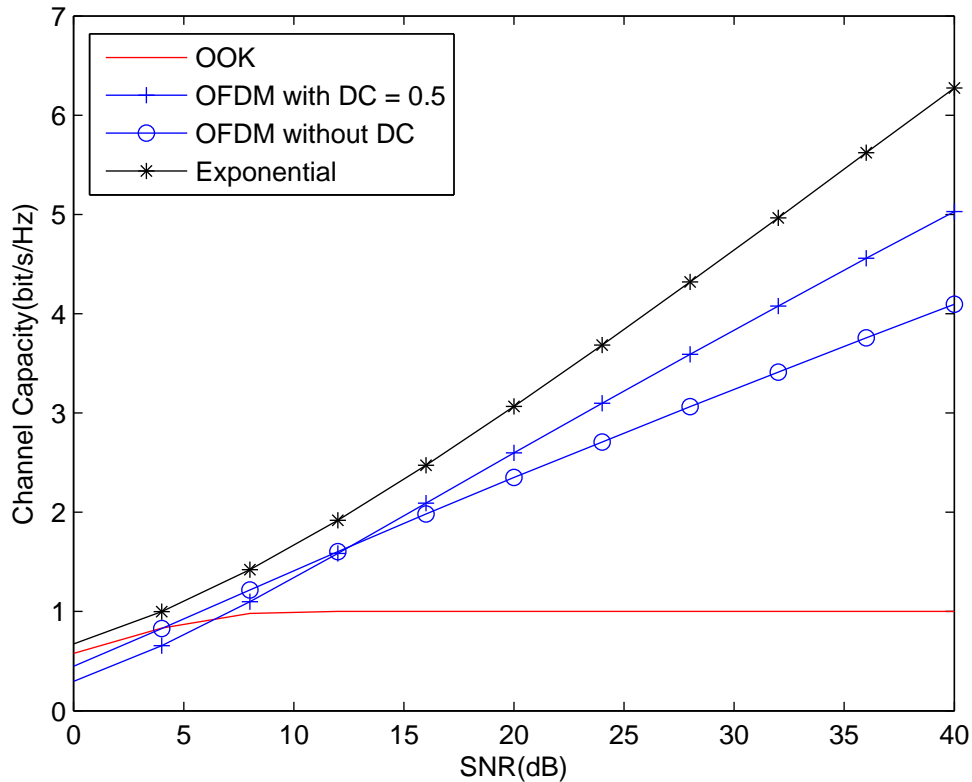

Figure 3-12: Channel capacities for four different cases under unit average power constraint

From the result, we can see that exponential distribution indeed gives us best performance among all cases. Also OOK scheme has a maximum value of 1 which matches the conclusion in [Hra04]. When SNR is smaller than 12 dB, DMT without DC offset has better performance than DMT with DC offset. This is because it has larger variance so that noise has less impact on it than the other DMT scheme. However, when SNR is larger than 12 dB, the impact of noise is getting smaller.

Therefore, DMT with DC offset, which has less distortion due to fewer clipped signals, becomes better than the other DMT scheme. But it is obvious that both DMT schemes can greatly outperform OOK, which has been adopted very often due to its energy efficiency and simplicity, in the way of potential rate can be achieved.

We conduct two different analyses on BER and channel capacity. The results reveal that the tradeoff DMT faces is between rate and robustness. It can increase the achievable rate, but faces great error performance under low SNR. These are the reasons that most of high speed (≥ 100 Mb/s) VLC systems adopt DMT but are limited their usage for short range indoor applications where good SNR is a fair assumption.

3.4 Summary

In this chapter, we first discuss the modeling part of VLC for indoor scenarios. Based on a signal attenuation model, we are able to predict the performance of several different parameters. The results reveal the facts of using blue filtering technique and establish a tool for performance analysis for any indoor VLC systems.

A general discussion on DMT also provides reason for adopting it in VLC. BER performance shows DMT is able to reduce the error in high SNR cases where multipath distortion becomes more severe than noise, while OOK scheme alone can't solve multipath distortion. Furthermore, DMT can improve the channel capacity closing to the optimum situation which is way better than OOK scheme can provide. The analysis shows the tradeoff between rate and robustness under low SNR. Furthermore, although DMT requires more cost on design comparing to OOK, it actually requires less cost than OFDM due to the facts of baseband modulation and no imaginary part in the transmitted symbols.

Chapter 4

Multi-hop Multi-access VLC Solution

In the chapter, we introduce our design on a multi-hop multi-access VLC solution. As described in Section 1.2.3, there are two unique characteristics different from RF that any VLC systems cannot ignore: LOS and directionality. Different from RF signal, optical signal hardly penetrate most of objects in our daily life. And even the diffuse lighting devices provide little lumen at the edge of their radiation patterns, which results the directionality of optical signal. These characteristics are like double-edged swords. They can favor certain performance such as rate and security, but they also aggravate any problems on reliability, contention and coverage. In order to adopt VLC in indoor scenarios and build a robust system, solving these problems is inevitable.

In this chapter, we propose a solution with two novel protocols and a novel scheme working together at networking layer, and therefore, don't require much modification on physical layer. We demonstrate that by adopting them, not only the problems can be solved, but also better performance can be achieved to meet the goals described in Section 1.3.1, and more importantly, without any additional cost on more comprehensive signaling or device design, which indicates that the solution and the analysis results can be also applied to other VLC systems and prototypes.

Furthermore, since in this solution, every device needs unique identification, IP technique can be integrated to make the system compatible with other networks and be able to have access to Internet.

There are two main parts of our proposed solution.

4.1 Networking Protocols for Blocking of Service Challenge

One of the most important characteristics of VLC is signal occlusion of the LOS channels. As mentioned in Section 1.2.3, different from RF, although visible light is more able to be reflected due to its larger refractive index than IR, both still suffer from signal attenuation that can make the receive SNR very poor. And furthermore, signal penetration of any non-transparent objects is physically impossible. We refer this problem as blocking of service in this dissertation.

One proposed solution is MSD introduced in Section 2.1.5 with imaging diversity receiver. It provides service by beaming the signal to the ceiling to form several reflected light sources with Lambertian reflectance pattern. If a surface exhibits Lambertian reflectance, light falling on it is scattered such that the apparent brightness of the surface to an observer is the same regardless of the observer's angle of view. However, the source needs to be located at a desktop level, and fixed to provide stable light sources. Therefore, any small change on the source location will be enlarged and can greatly change the coverage pattern of the system. Besides, having a visible light source at desktop level may cause annoyance for human eyes.

We present two network solutions for this problem through the use of relays for data through other nodes or hosts, and have a comprehensive performance analysis based on the assumption of CSMA/CA as MAC scheme. Also, a unique design of receiver device is introduced to support one of these network solutions.

4.1.1 System Model

The general model and our goals have been introduced in Section 3.1.1 and Section 1.3.1. In this section, we continue with more details.

Part of the user device is an extension from [YAKD09] while the rest of whole system is an original design. Briefly, the system is comprised of two layers, ceiling

level base station and desktop level user device. The base station has access to the backbone network through traditional wired or wireless communications. It collects requests from user devices under its coverage and then provides services accordingly so that bridging user devices with Internet. Figure 4.1 demonstrates the architecture.

Base Station

The base station is equipped with diffuse transmitter and wide FOV receiver. The reason is it needs to provide access points to multiple users below it in a large area, and also, for illumination, the ceiling level lamp has to be a wide diffuse link model for optical signal. Based on the design of illumination device, the white light of the lamp is comprised by three different color LEDs, red, green and blue. First of all, this property gives the system ability to simply achieve multiple services by grouping different service users with one same color LED for communication. The base station modulates different color LEDs separately based on different service requirement that they can transmit data exclusively and simultaneously without interfering each other. In simple words, it can introduce more diversity simply and directly. The receiver of base station still uses traditional photon-detector for IR spectrum. The reason is due to the user device which is discussed in Section 4.1.1. However, due to diffuse link and wide FOV, sophisticated signaling techniques are required to combat adverse effects, which are out of scope of this dissertation.

User Device

The design of desktop level user device is much more complicated since it is responsible for both communication between other user device and base station. The fundamental shape of the device is hexagonal cylinder which is shown in Figure 4.2. The original idea is a honeycombed sphere which comes from [YAKD09]. However, this design is not suitable for us.

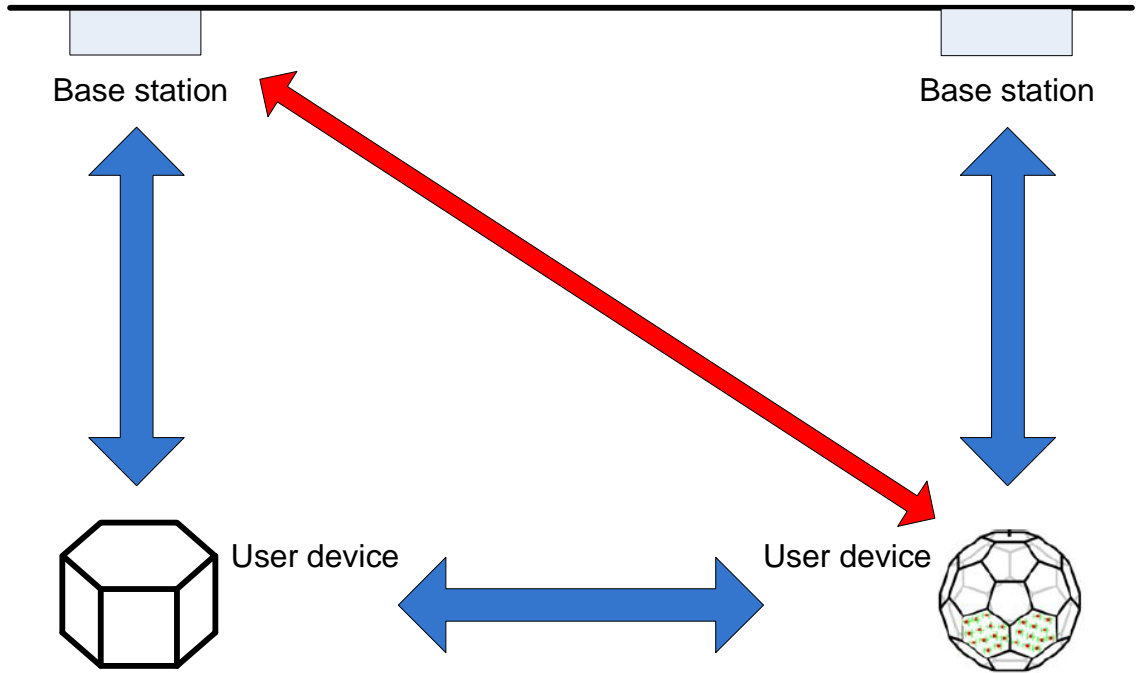

Figure 4-1: Transmission architecture and interference by using honeycombed sphere user device

First, despite the circuit, if we put 10s of LEDs on each face, hundreds of LEDs are required such that the size and cost will become concerns.

Second, in our system, the faces are assigned to two jobs explicitly, top face for desktop level and other faces for ceiling level communications. For honeycombed sphere, there are faces with FOV between horizontal and vertical. As illustrated in Figure 4-1, in a typical honeycombed sphere, about 6 faces can transmit signal to other base stations (or 15 faces depending on horizontal distance between the device and other base stations). Therefore, if those 6 faces are used for transmission, we will have interference on or from 17.84 percent of total transmission area (12 pentagons and 20 hexagons), and if not, 17.84 percent of total transmission area is just wasted.

In this dissertation, we will add more features to fit our design goals. They include ad hoc solution for LOS requirement, multiple access control. As we have clarified in the Section 1.3.1, the main challenge of FSO is pushing the more general diffuse

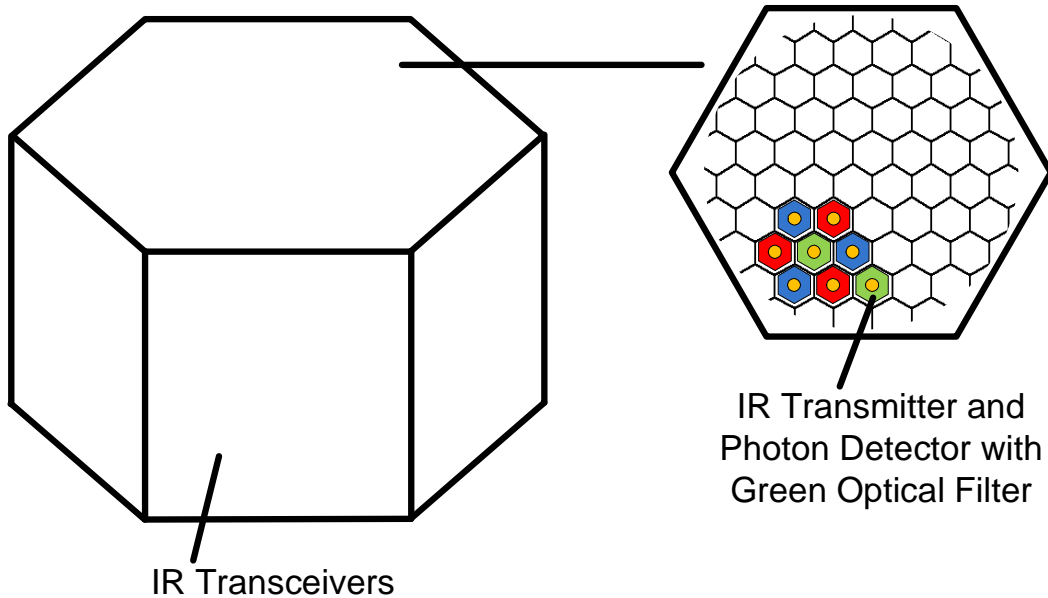

Figure 4.2: Desktop level user device

link to be capable for high speed which is the advantage of point-to-point link until now. This new design of the device can fill the space by using multiple independent transceivers, each of which can have much narrower FOV and beams to reject more background noise and therefore increase the signal attenuation.

The top face which is responsible for the communication with base station is quite different from the rest of faces. If the white light from lamp consists of red, green and blue, we can equip the receivers with one, two or three different optical filters (the filtering band should be exclusive from any of the other two) for different colors as indicated in Figure 4.2. This is for the purpose of exclusively receiving of different services or achieving multiple communication channels for high data rate.

The rest of faces are responsible for the communication with other user devices. By carefully designing the device, we can let it achieve nearly omni-direction at desktop horizon. Also, since the transceivers on each face are independent from those

on other faces, simultaneous communication can be enabled between multiple user devices. Furthermore, since the omni-direction is covered by multiple faces, the link model is approximately point-to-point (quasi-point-to-point) and the FOV is much narrower than the top face. This advantage can greatly reduce multipath distortion and background light noise so that the transceiver design is much simpler. However, angle diversity is achieved with the expense of spatial reuse.

Generally, we still use IR transceivers for the faces other than top face and IR transmitter for the top face. This is because in a real situation, multiple visible light sources at desktop level could be very disturbing to human eyes. RF could still be a choice, but we can reuse some of the existing optical components for the communication with the base station that we can simplify the design and save some cost. By sticking with IR, the searches could be also very general in the FSO area.

Another great advantage of the user device is it can support certain degree of mobility and solve the LOS blocking problem which is especially important for point-to-point link model. When the face lost LOS of its communication object, the user device will automatically trigger a searching procedure and resume transmission after reconstruction of the data link.

In [YAKD09], researchers did intensive analysis on coverage and range. In this dissertation we provide analysis on connectivity performance and available throughput in Section 4.1.3.

4.1.2 Networking Protocols

Because of the inherent property of light mentioned before, LOS is required to provide continuous connectivity. Although signal reflection still exists, this configuration suffers from a high signal attenuation due to the absence of a direct path and data-rate limitation caused by reflections. This latter limitation results from multipath

distortion caused by different paths (including reflections off of walls and ceiling) the signal takes to travel to a receiver [AK03].

Considering the scenario in Figure 3.2, there are two possible solutions for this problem. Each of them has its advantages and disadvantages which make them suitable for different application scenarios.

Peer-to-Peer Protocol

Wireless ad-hoc networks has been widely studied with multihop and even multicast for years in the area of RF. However, regularly, in free space optical, since there is no omni-direction signal, most of existing protocols and solutions cannot simply apply directly to our research. Our architecture gives us opportunities to change the situation.

The first protocol achieves the goal of solving blocking by exploring the possibility of peer-to-peer communication among user devices. It is very similar to the research of wireless sensor networks in RF area. Basically, when blocking happens between two nodes, the source node will start a search procedure through other nodes in the network to find a multihop path. However, since the device has multiple faces, each of which can send data independently, the procedure and information required are very different from the routing protocols in RF. The procedure is introduced as following in brief:

1. When connection between two nodes is interrupted, the source node will first check all other faces that if destination node exists in the LOS of any of them. If yes, nodes can reestablish the link through new faces on both devices. If not, that means the interrupt is due to either out of range or blocking, both of them require additional steps. In the meantime, the destination node will also update its local neighbor table by sending out Neighbor Discovery Packet (NDP) with

- its ID information and depth count (how many hops allowed along the path).
2. The source node first checks its own local table to see if a route already exists for the destination node. If yes, source sends validate packet to check and reestablish the link if link is valid.
 3. If there is no such route in the local table or the path is no longer available, source sends Reactive Route Discover Packet (RRDP) with preset forward depth count looking for rendezvous node which has the path to the destination node. If in a given period of time (associated with forward depth count) there is no response from any node, we consider that there is no such rendezvous node. Then the transmission terminates.
 4. If rendezvous node does exist, when it receives such RRDP, it will send out the same format validate packet mentioned in step 2. And if no response, source node entry will be deleted from rendezvous nodes neighbor list.
 5. If all possible rendezvous nodes fail on validating the paths, the source will not be able to be notified in the given period of time and the transmission terminates. Otherwise, rendezvous nodes send back confirm packets with path information. Source node will examine and choose the best route to reconstruct the transmission.

We can describe the steps as illustrated in Figure 4-3 and also as in following pseudo code algorithm:

Source Node:

Function Reconnect

begin

```

    if (LOS_Check(all faces, destination) == True) //reconnect by new face
        set comm_face = new face;
        Transmit(destination,comm_face);

```

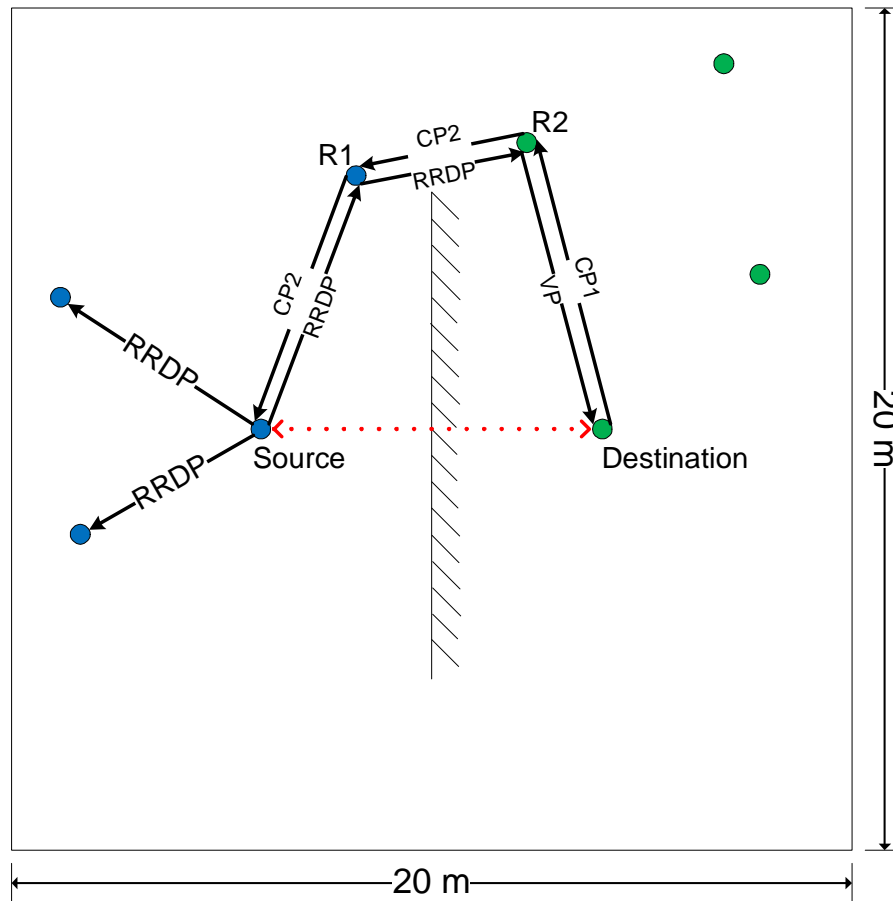

Figure 4-3: Peer-to-Peer protocol illustration

```

else if (RouteTable_Check(destination)) //reconnect by existing route
  if (Route_Validate(Table_Entry) == True) //validate the route
    Route_Update();
    Transmit(destination,comm_face);
  end
else
  Route_Search(forwarddepth,destination); //search new route
  if (Timeout(WaitTime) == True)
    return False; //no new route, reconnect fails
  else
    Route_Update();
    Transmit(destination,comm_face);
  end
end
return Success;

```

end

Rendezvous Node:

Function Relay

begin

```

if (PacketType == Data) //forward data packet
    [NextNode,face] = RouteTable_Check(destination);
    Transmit(NextNode,face);
else
    if (TTL != 0)
        if (RouteTable_Check(destination) == True) //check own neighbor list
            if (Route_Validate(Table_Entry) == True)
                Route_Confirm(source); //send back confirm with new route
            else
                return False; //drop request and invoke neighbor update
            end
        else
            Flood(packet,TTL-1); //if not in neighbor, forward request
        end
    end
end
return Success;

```

end

The formats of six packets used in the steps are shown in the Table 4.1. Time to Live (TTL) is required to prevent message flooding. They are actually the same with depth counts introduced in the previous procedure steps. Inter-nodes means all the nodes along the path of that message traveled.

NDP	TTL1(hop #), previous id(prevent loop), source id]
RRDP	TTL2(hop #), all inter-nodes, source id, destination id]
Local Table	source id, hop #, face #, next node id]
Validate Packet	destination id, hop #]
Confirm Packet 1	check]
Confirm Packet 2	[The final TTL2(hop #), all inter-nodes(include rendezvous node), hop # from rendezvous node table]

Table 4.1: Packet format of Peer-to-Peer protocol

The reconnectivity justification of the protocol will be presented in Section 4.1.3.

Peer-to-Host Protocol

The other protocol includes hosts and the base stations at the ceiling level in our system for relaying the data. We consider the network as a two-layer geometry; nodes and base stations. Between every two peer nodes, there is only direct transmission and no multihop. Otherwise, the source node has to go through the host(s) to reach the destination node. We consider this in detail in the following steps.

1. The first step is very similar to that of the peer-to-peer protocol. The source node will first try to find alternative direct contact with destination node through other faces, and reestablish the link through new faces on both devices if available.
2. If there is no direct contact, source node will send a Source-to-Host (StoH) packet to its own host (Host A). The host then checks its node list to find out if the destination node is also under its coverage. If yes, a validate packet will be sent to check the availability.
3. If destination node is not in the list or there is no confirmation, host A will send out a similar request, Host-to-Host (HtoH) packet, to all its neighbor hosts in the local network (for example, all other ceiling lamps in the same office room).
4. Every peer host will check its own node list based on the information in HtoH. If the destination node exists, the corresponding host (Host B) will also need to check the link validation.
5. Similarly, if in a given period of time no response is sent back due to either no host has destination node in list or the link no longer exists, we consider the transmission terminated. Otherwise, the destination node will confirm the link

to B, and then B will confirm to A and source node, so that the link can be reestablished.

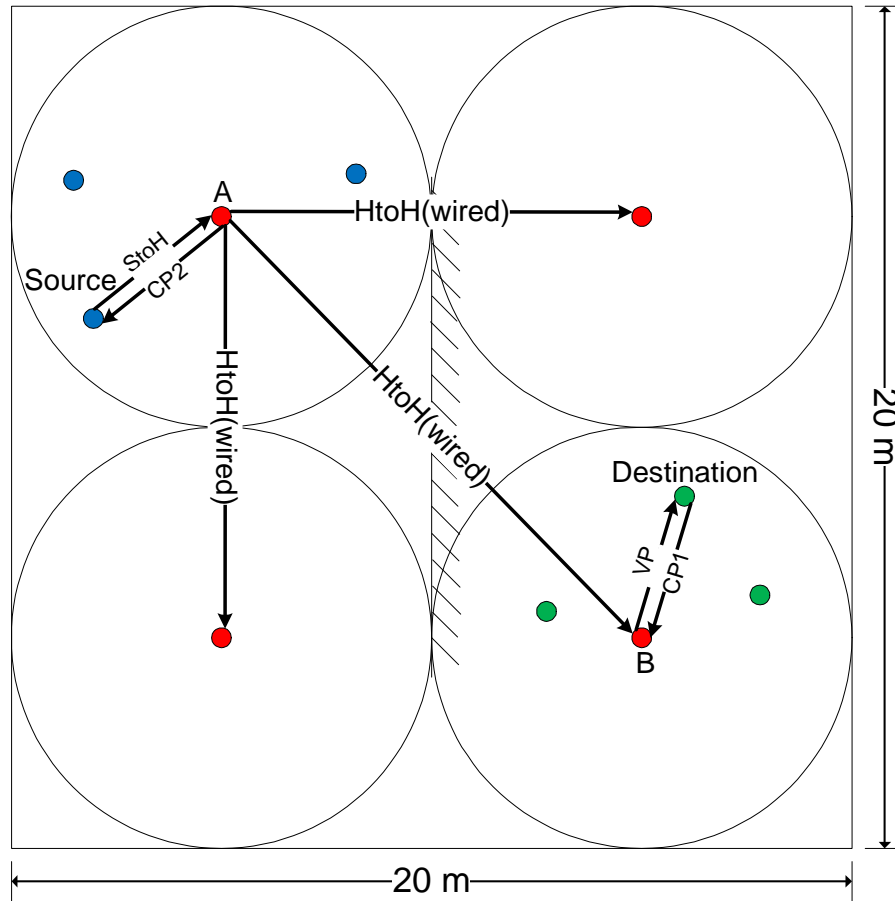

Figure 4-4: Peer-to-Host protocol illustration (cluster heads are marked with red)

Similarly, we can describe the steps as illustrated in Figure 4-4 and also as in following pseudo code algorithm:

Source Node:

Function Reconnect

begin

```

if (LOS_Check(all faces, destination) == True) //reconnect by new face
    set comm_face = new face;
    Transmit(destination,comm_face);

```



```

    else
        Route_Search(destination); //search route through hosts
        if (Timeout(WaitTime) == True)
            return False;
//no new route, reconnect fails
        else
            Route_Update();
            Transmit(destination,topface);
        end
    end
end

Host:
Function Relay
begin
    if (PacketType == Data) //forward data packet
        NextNode = RouteTable_Check(destination);
        Transmit(NextNode);
    else
        if (TTL != 0)
            if (NodeList(destination) == True) //check own node list
                if (Node_Validate(destination) == True)
                    Node_Confirm(source); //send back confirm with new route
                else
                    return False; //drop request and invoke node update
                end
            else
                Flood(packet,1); //if not in coverage, forward request to other hosts
            end
        end
    end
    return Success;
end

```

The formats of six packets used in the steps are shown in the Table 4.2.

The reconnected justification of the protocol will be presented in Section 4.1.3.

4.1.3 Connectivity and Rate Performance Analysis

We first discuss reconnected performance by simulations.

StoH	[source id, destination id]
HtoH	[destination id, source id, Host A id]
Host Table	[node id, channel id(if FDMA), PN code(if DSSS)]
Validate Packet	[destination id]
Confirm Packet 1	[check]
Confirm Packet 2	[Host B id, Host A id]

Table 4.2: Packet format of Peer-to-Host protocol

We consider a scenario of 20 m by 20 m room. The forward depth count is set to 2, and the neighbor depth count is set to 1. The communication range is a radius of 10 m. We iterate 10,000 times. The transmission is between two nodes located at (6,10) and (14,10). The block is a wall from (10,4) to (10,16). We calculate a Reconnectivity Success Ratio for different numbers of users.

Also in the scenario, we put 4 hosts and the coverage radius of each host of 5 m, corresponding to one fourth of the room side length. All nodes are deployed randomly in the room.

The third protocol we consider here is a hybrid solution by having both protocols we have introduced. If the peer-to-peer protocol fails to find a route, the peer-to-host protocol will be activated. The solution fails only if both protocols fail.

The two scenarios are also illustrated in Figure 4-3 and Figure 4-4.

Figure 4-5 shows that the peer-to-peer protocol needs more nodes to achieve high reconnectivity successful ratio. When the number of users reaches 20, the ratio is close to 90 %. On the other hand, peer-to-host protocol has a stable reconnectivity successful ratio, mainly due to the fact that in this protocol the successful reconnection only depends on if both two nodes are under the coverage of 4 hosts. The hybrid solution can greatly increase the performance, and therefore is the best choice in terms of reconnectivity.

However, the good performances of hybrid solution and peer-to-peer protocol for more nodes come with a price. Both increase additional overheads that burden the

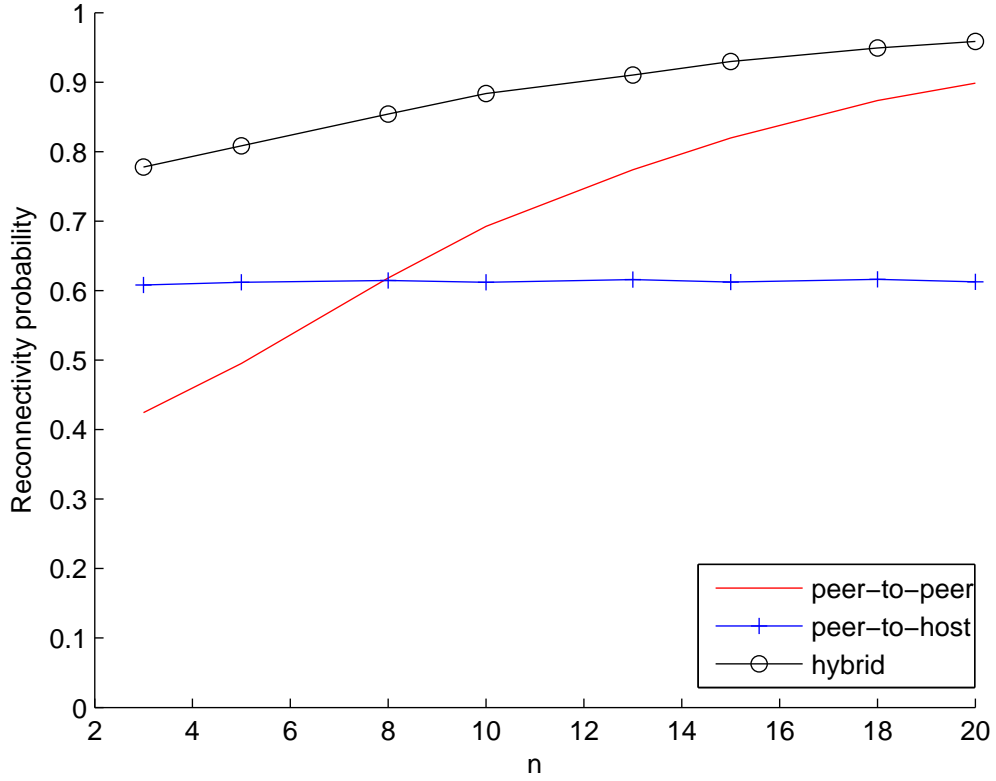

Figure 4.5: Reconnectivity success ratio of p2p, p2h and hybrid protocols

system. For the peer-to-peer protocol, the overheads to the whole network equals $AverageEntry * \sum_{k=0}^{forwarddepth-1} (AverageEntry - 1)^k$. For example, in our simulation, when there are 20 users, the average entry is 7.67 neighbors, which makes the overheads as high as 58.7 routing packets. While on the other hand, peer-to-host protocol only requires limited overheads to find the path through hosts (the burden to the whole network is always 1). And since hosts are fixed infrastructures, none of these overheads are required to be flooded to the network. Similarly, the burden to each node is the entry amount in the neighbor table. In our simulation, we only consider one depth neighbor which has an average of 7.67 neighbors for 20 users. If the depth becomes 2, this burden will be 13.1 neighbors which is greatly increased

with the change of such depth count.

In Chapter 4.2, we propose a new MAC scheme. Here we just use existing scheme for simplicity. There are several solutions for multiple access. However, the user device is normally expected to be small. Therefore, the technique used for uplink and node to node communication should be simple scheme with easy implementation. A good choice is CSMA/CA. It is one of the most popular schemes for MAC and it has been used in 802.11 based Wireless Local Area Networks (WLAN). The hidden node problem can be solved by its extension with hand-shaking protocol.

However, since it is not simultaneous access and there is still chance of collision, the real rate is actually lower than the system capacity. In [Bia00], the author presented a theoretical model for CSMA/CA. By using this model and customizing it to our specific architecture, we can identify the packet transmission probability, τ , and conditional collision probability, p . Considering a CSMA/CA with a contention window of W and maximum backoff stage of m , from [Bia00] we have

$$\tau = \frac{2(1 - 2p)}{(1 - 2p)(W + 1) + pW(1 - (2p)^m)}. \quad (4.1)$$

We consider the worst case that every node always has a packet to deliver. For the uplink of node to host communication, if more than one node chooses the current time slot to transmit, collision will occur at the host. So, for n nodes,

$$p = 1 - (1 - \tau)^{n-1}. \quad (4.2)$$

For node-to-node (p2p) communication, the analysis is more complex. We know that the user device has six faces, so the transmission from nodes which are not within the FOV of face sending the packet are not going to interfere. Even for the node within that FOV, if they don't have packet to transmit at the same time slot,

the collision will not occur. Therefore, the new collision probability is

$$\begin{aligned}
 p &= 1 - \sum_{k=0}^{n-1} \binom{n-1}{k} \left(\frac{5}{6}\right)^{n-1-k} \left(\frac{1}{6}(1-\tau)\right)^k \\
 &= 1 - \left(1 - \frac{1}{6}\tau\right)^{n-1}.
 \end{aligned}$$

By solving these two formulas we are able to have a unique pair of results for τ, p . Before evaluating the throughput, we need to define the time variables. Based on 802.11 MAC specifications, we set them as in Table 4.3.

Table 4.3: Time variables definition [Bia00]

Payload size	8184 bits
MAC header	272 bits
PHY header	128 bits
ACK	112 bits + PHY header
RTS	160 bits + PHY header
CTS	112 bits + PHY header
Propagation delay (δ)	1 μ s
Slot time (σ)	50 μ s
SIFS	28 μ s
DIFS	128 μ s

There are three cases for any time in the transmission procedure; empty time slot when every node is in the backoff contention window, failed transmission (require time length of T_{fail}) when there are more than one nodes sending out the Request to Send (RTS), and successful transmission (require time length of T_{succ}) when only one node is trying to send out the RTS. Therefore, based on CSMA/CA scheme, reference [Bia00] shows

$$\begin{aligned}
 T_{succ} &= \frac{RTS}{rate} + SIFS + \delta + \frac{CTS}{rate} + SIFS + \delta + \frac{Header}{rate} \\
 &\quad + \frac{Payload}{rate} + SIFS + \delta + \frac{ACK}{rate} + DIFS + \delta, \\
 T_{fail} &= \frac{RTS}{rate} + DIFS + \delta.
 \end{aligned}$$

We define normalized throughput as the ratio of real statistical rate, which is the average device throughput under worst case, over the capacity the device. Therefore, we have our formula:

$$S = \frac{n\tau(1-\tau)^{n-1}(\text{Header} + \text{Payload})/\text{rate}}{(1-\tau)^n\sigma + n\tau(1-\tau)^{n-1}T_{succ} + (1 - (1-\tau)^n - n\tau(1-\tau)^{n-1})T_{fail}}. \quad (4.3)$$

Considering the average throughput for each user, for uplink transmission, we need to multiply S with device capacity (maximum rate) and for total throughput of node-to-node links, further multiply the number of faces on each device, since all faces can work in parallel without interfering with each other.

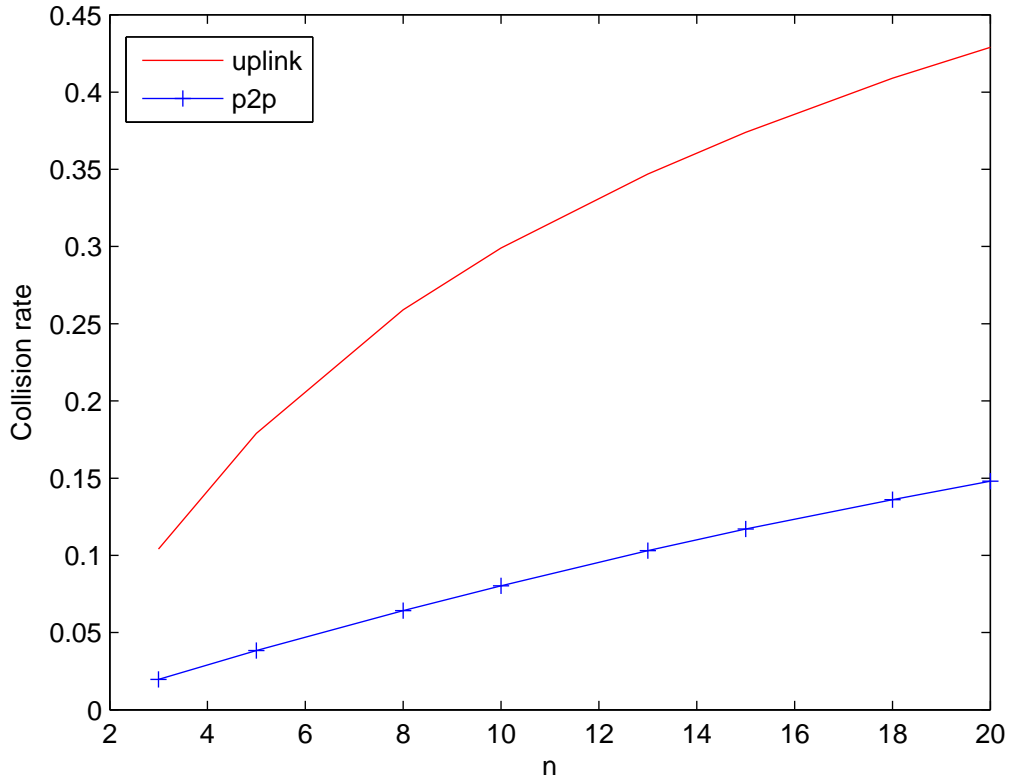

Figure 4-6: Collision rates

By splitting the horizon into 6 parts, the probability of collision can be greatly

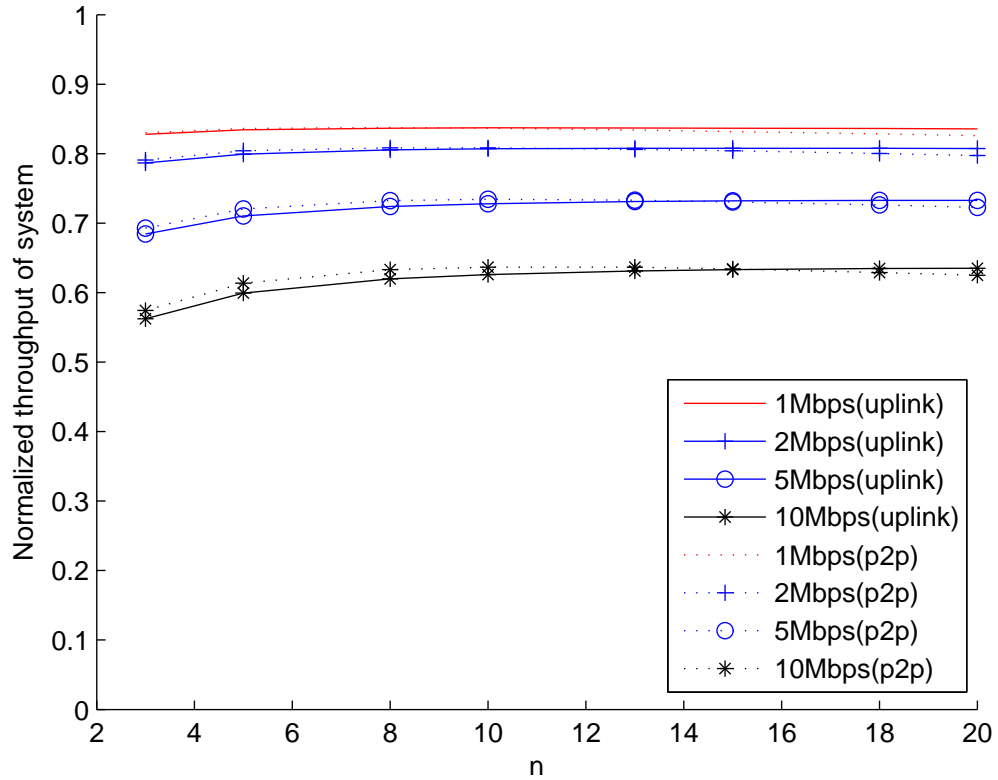

Figure 4-7: Normalized throughput of system

reduced as shown in Figure 4-6. This is because the area can introduce collisions has been reduced to one sixth.

In Figure 4-7, the node-to-node protocol, however, doesn't give much efficiency boost over uplink transmission. This is because τ is not very large so that its increase does not substantially improve the overall system performance. Also, we see that high speed can result low efficiency since the time ratio of payload will be decreased by increasing the rate.

Even though, due to the parallel transmission ability, the user throughput can still be greatly improved. We consider the rate capacities for uplink and node-to-node transmission to be 2 Mb/s and 10 Mb/s respectively. In Figure 4-8, the result

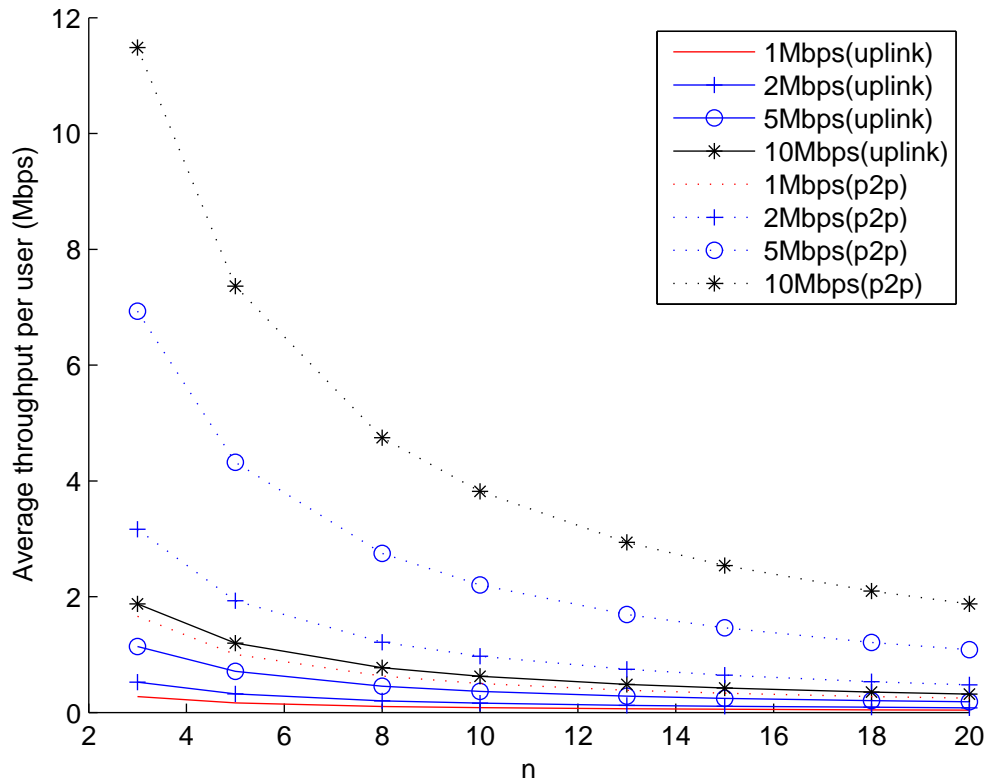

Figure 4-8: Average throughput of user

shows that for uplink transmission in the four user case, each user can have an average rate of 422 kb/s, and for node-to-node communication, the average rate is over 9 Mb/s giving the transmission on every face a minimum rate in excess of 1.5 Mb/s.

Remembering that the performance is calculated under the worst case scenario in which every node always has packets to send, therefore the results represent the lower bounds of the performance. Based on all above, Table 4.4 generalizes our observations.

Table 4.4: Comparison of two protocols

Performance	Peer-to-peer	Peer-to-host
Complexity	High	Low
Overhead	High	Low
Mobility	Low	Medium
Speed	High	Low
Interference	Low	High
Burden to Host	No	Yes
Outdoor Extension	Yes	No

4.2 Centralized Optical MAC Scheme

For any WLAN, multiple access is always a very important feature. Due to the low complexity and low cost requirements, most indoor wireless systems adopt simple MAC schemes. CSMA/CA is one of the most popular schemes for MAC and it has been used in 802.11 based WLANs. Although it still faces problems like mask-node problem, under most of cases it can provide satisfactory performance with minimum complexity.

As we mentioned, directionality is another important characteristic of VLC. Diffuse link suffers from high signal attenuation, especially at the edge of the coverage. Therefore, most of VLC systems which expect high rate transmission cannot have large single coverage and FOV, and they need multiple light sources to cover a large area, such as a conference room. This not only raises the question on how to smoothly switch from one access point to another, but also brings a new multi-access contention problem which omni-directional RF signal doesn't face.

We start with the discussion on CSMA/CA and other existing MAC solutions. Then, a new MAC scheme is provided with performance analysis. The conclusion is given at the end of chapter for an overall comparison.

4.2.1 Problem Definition

As mentioned, in VLC, the scenarios are different from RF systems. First, the directionality of optical signal makes channel sensing becoming much more difficult in FSO. Second, due to high signal attenuation at the edge of the illumination pattern, the coverage of the transceiver is greatly limited. Together, that means, any scenarios with mobility face more challenges from handling access point switch, resource allocation, user management and contention interference.

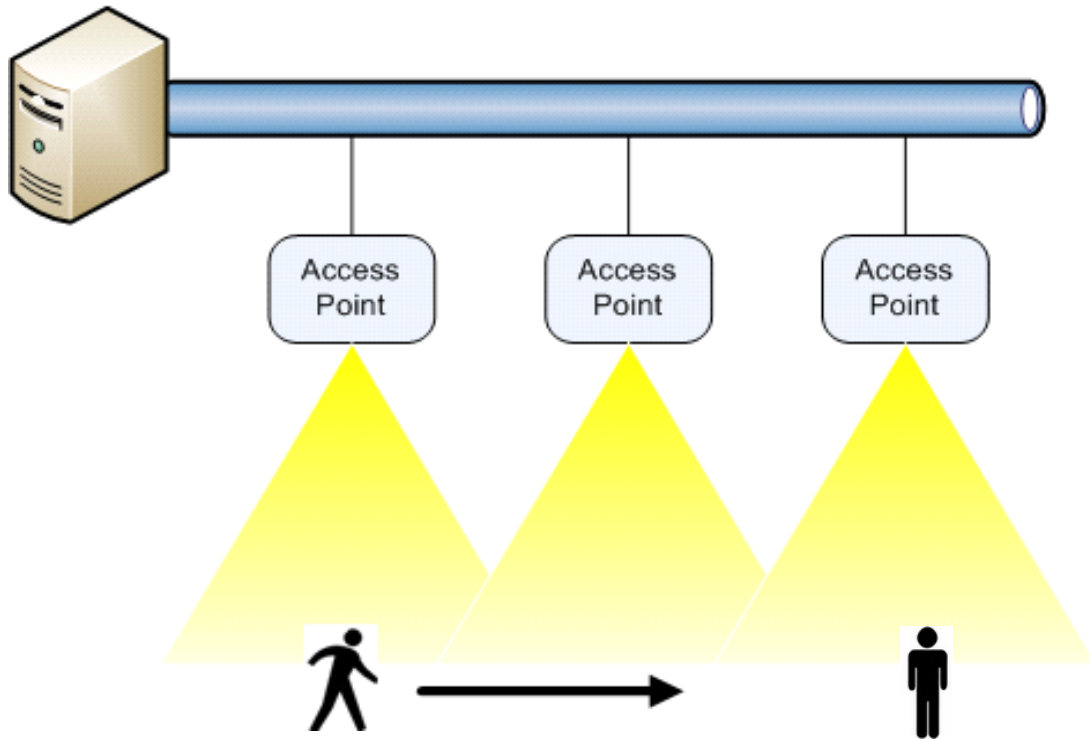

Figure 4-9: Illustration of MAC scenario

Based on our project goals described in Section 1.3.1, we define our user scenario as follows, which is also illustrated in Figure 4-9:

- We continue considering indoor applications for office use with multiple light sources (access point) to provide illumination and communication to the user

devices in the coverage.

- The users can have mobility so that constantly entering and leaving from one access point to another are highly expected.
- All user devices are facing up for the transmission between the access points. The node-to-node function described in Section 4.1.1 is not available here yet, since it does not relate to transmission between user and access point.

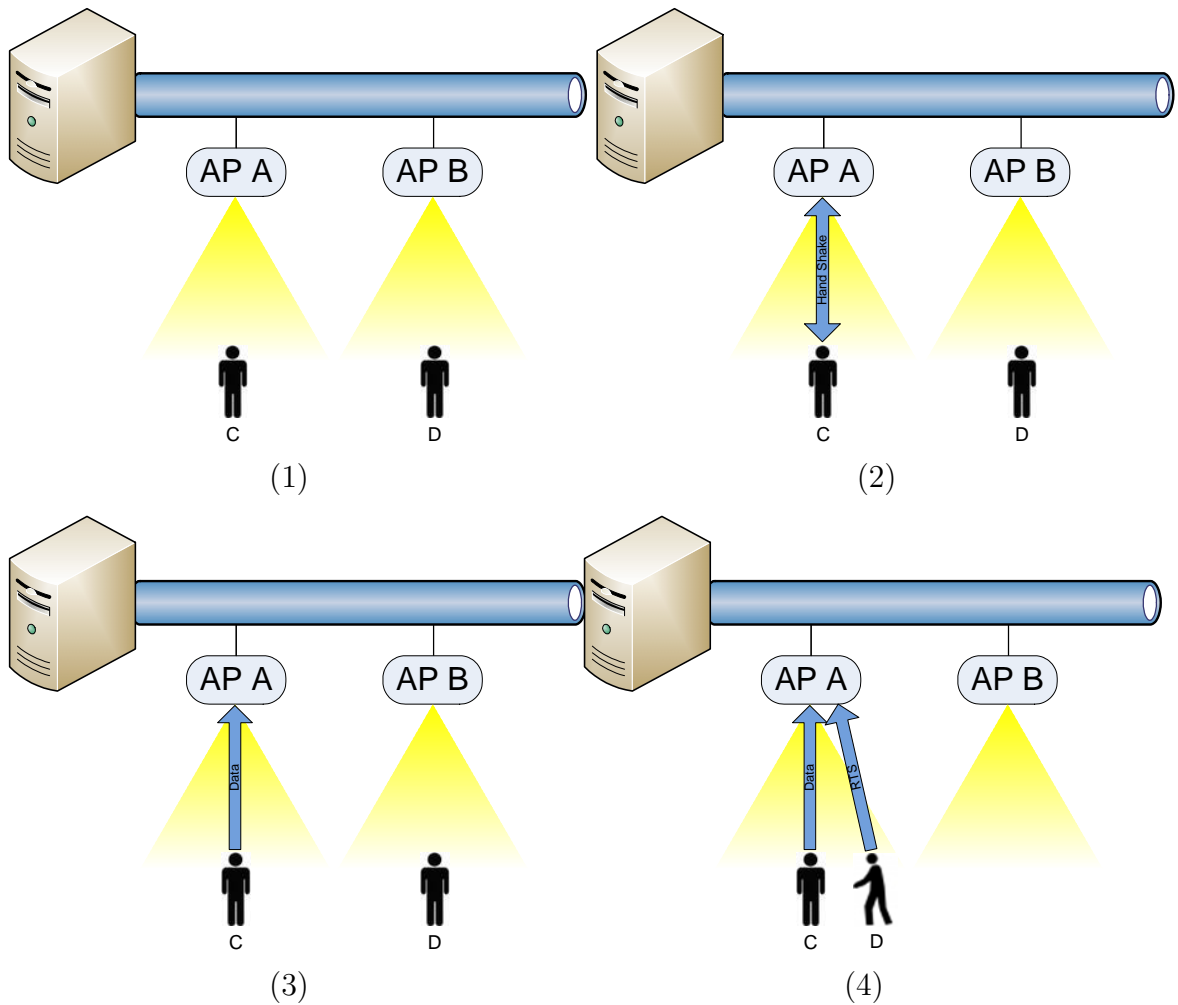

Figure 4-10: Illustration of mobile nodes collision in indoor FSO systems

Therefore, we see that the user device has no access to other nodes' transmission status. Figure 4-10 demonstrates the collision due to this unique characteristic of indoor FSO system. We explain the simple two access points scenario in Figure 4-10 as follows:

1. Initially, there are two users, C and D, belonging to different access points, A and B. And both are static for now.
2. User C starts a new transmission request to its access point A with standard hand-shaking procedure.
3. After the successful hand-shaking, user C starts uploading data through access point A.
4. In the mean time, user D starts moving from its original access point B to the new access point A with either an undergoing transmission or a planning transmission. However, since user D's FOV does not cover user C, it cannot sense the channel usage situation in the coverage of access point A. Therefore, any packet from user D will cause collision at the access point A.

4.2.2 Existing MAC Solutions

As we have mentioned, there are several choices for low complexity, low cost MAC schemes for indoor applications. We briefly introduce and discuss their feasibility in our VLC system here.

CSMA/CA

The unique problem we are trying to solve is actually not a problem for CSMA/CA in RF. This is due to the fact that all packets (RTS, Clear to Send (CTS), Data, ACK) are sent omni-directionally. Whatever status (RTS, CTS, Data transmitting or idle)

between two existing transceivers (source and destination), the new enter node can always acknowledge whether there is an undergoing transmission or not by Carrier Sensing (CS) the channel status. However, we just cannot use it for the fact of our limitation on the directional optical device as demonstrated in Figure 4-10.

There are also some modified directional CSMA/CA schemes developed in recent years given in Table 4.5 (The third one is a modification of D-MAC).

	RTS	CTS	Data	ACK	Receive func.
802.11	O	O	O	O	O
D-MAC	D/O	O	D	D	O
Nasiouri, etc.	O	O	D	D	O
DVCS	D/O	D	D	D	O
MMAC	D/O	D	D	D	O
Circular-MAC	Circular D	D	D	D	O

Table 4.5: Orientation characteristic of Directional CSMA/CA schemes

- The first one and most well-known one is Directional MAC (D-MAC) scheme presented in 2000 [KSV00]. It assumes multiple directional antennas used to cover the all directions. The assumption of the knowledge of exact locations of nodes can be obtained by GPS. And, RTS can be sent either directional or omni-directional while CTS is sent omni-directional. The hand-shaking mechanism is the same.
- Another MAC scheme is proposed in [NYYH00]. It assumes multiple directional antennas used to cover the all directions. Omni-directional RTS/CTS are used to determine the relative direction of source and destination in order to transmit directional data.
- Directional Virtual Carrier Sensing (DVCS) is another important scheme proposed in 2002 [TMRB02]. RTS can be either directional or omni-directional

depending on the knowledge of Angle of Arrival (AoA) of destination. After that, from CTS to ACK, transmission is directional by beam-forming.

- Later, Multi-Hop RTS MAC (MMAC), which is a improved version of D-MAC, is proposed in 2002 [CYRV02]. All packets are sent directional. However, the nodes still need omni-directional function to receive the RTS/CTS packets.
- Another modified CSMA/CA, Circular-MAC scheme [KJT03], also sends packets directional, but the RTS packet is sent to all directional one by one. And it also needs omni-directional function to receive the RTS/CTS packets.

Table 4.5 summarizes the orientation characteristics of the Directional CSMA/CA schemes we introduced. From it, we have following conclusions regarding to CSMA/CA schemes.

- This subset of directional CSMA/CA schemes are particular for the directional antenna (or directional ad hoc) networks.
- However, we can see that none of them can be totally independent from omni-directional functionality. The function is reserved for certain cases (such as sending RTS or receiving signal to keep track of neighbor locations).
- Some of the publications have discussed the issue of mobility. But their concern is about keeping tracking of the AoA of mobile neighbors, so that nodes can always change beam to the right direction. Even if we can overcome the high signal attenuation problem for diffuse link and enable the host to process data from different directions separately, the overall cost on overheads and more sophisticated device design will be greatly increased.

VLC MAC

There are also several researches on MAC particularly for VLC.

- **Inter-MAC** We have introduced OMEGA project in Section 2.2.1. Besides the researches on developing prototypes, they also presented their work on MAC. As described, in OMEGA project, multiple technologies have been integrated together to provide seamlessly transmission for different purposes. In order to achieve its objectives, the OMEGA project needs a technology independent MAC layer (named Inter-MAC) to control this network and provide services as well as connectivity to any number of devices the user wishes to connect to it in any room in a house/apartment, and further, this layer will allow the service to “follow the user” from device to device [OME].

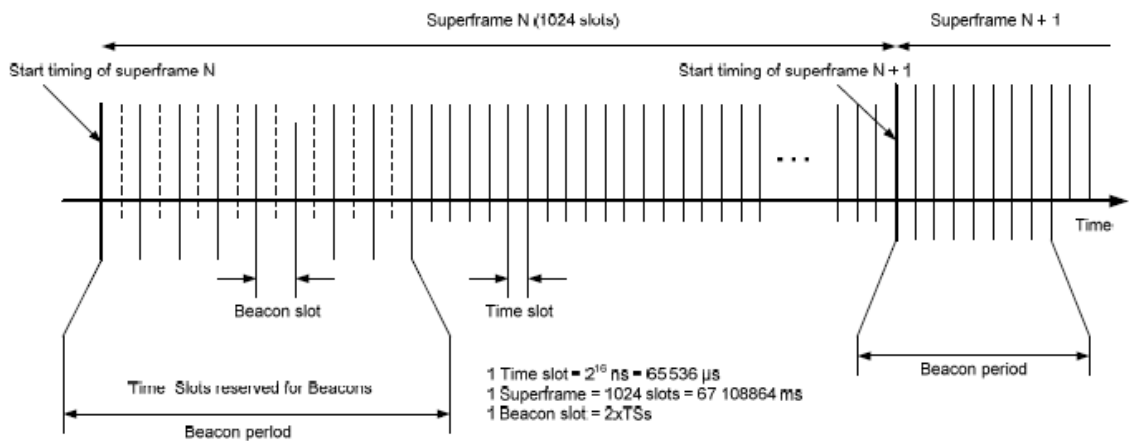

Figure 4-11: The superframe structure of Inter-MAC [OME]

In Inter-MAC, timeline is divided into superframe as illustrated in Figure 4-11. The superframe duration is 67.108864 ms. The superframe is composed of 1024 Time Slots, and the first 64 time slots are considered as beacon period which is used for synchronization and reservation request. The rest time slots are used for data transmission reservation. It requires a device to scan for beacons

for at least two superframes before it transmits any frames. Therefore, it has a minimum latency of 134 ms under the cases of no collision for messages in beacon period.

However, Inter-MAC is designed for high speed wireless applications (the time slots duration can be chosen for data rates varying from 128 to 1024 Mb/s). This is not included in the scenarios or applications we described in Section 1.3.1 and required support of better transceiver. Furthermore, when link is established in one superframe, it does not require additional beacons during following superframes with data transmission. If device stops the transmission due to the reason such as out of coverage, it will continue keeping the reservations which therefore compromise the throughput. Because of these characteristics, Inter-MAC is not a good choice for applications with mobility or rate lower than 128 Mb/s, and therefore will not be included into our analysis.

- **Optical CSMA/CD**

The system presented in [LIH09] demonstrates another way to use CSMA scheme. Basically, before sending out RTS, the user with task first detects the channel for any carrier being transmitted. After receiving the RTS (or corrupted packet by collision), the access point repeats the packet back to all users, and if the packet isn't consistent with RTS or other users' uploading data packet, this indicates a collision occurs at the access point.

However, it is not clear that when the access point should consider a packet as corrupted packet from collision and repeat back. And the assumption of detecting any carrier being transmitted makes the system very vulnerable to noises. The host could consider noise as corrupted packet and reply back to the whole network and therefore compromise the throughput.

- **IEEE 802.15.7 and 802.15.4 Standard (zigbee)**

In 2010, IEEE 802.15.7 Group published the first draft standard, PHY and MAC standard for short-range wireless optical communication using visible light [oEG11]. The standard includes comprehensive information which includes how multiple access should be processed. It adopts the similar MAC mechanism and scheme of 802.15.4 standard.

Basically, the timeline is divided into superframes which are bounded by network beacons. The active portion of each superframe consists of a Contention Access Period (CAP) and a Contention Free Period (CFP). A device that wishes to communicate during the CAP competes with other devices using CSMA/CA mechanism. On the other hand, the CFP contains Guaranteed Time Slots (GTSs). The GTSs appear at the end of the active portion starting immediately following the CAP. Figure 4-12 illustrates an example of the superframe structure.

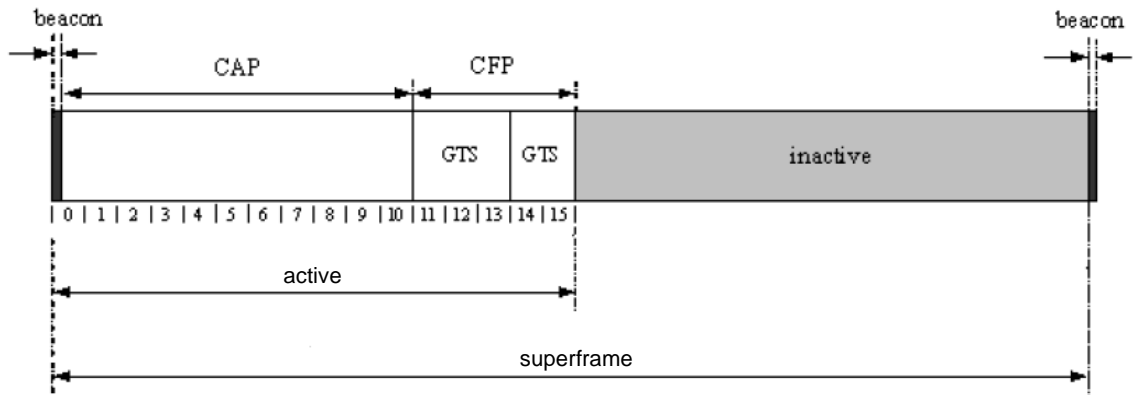

Figure 4-12: An example of the superframe structure [oEG11]

The advantage of using beacons is preventing any user devices from sending information without notification. Therefore, by containing the random access contention within a certain period, the interference we discussed can be solved.

However, there are several disadvantages:

1. The lengths of superframe and its periods are fixed. A device transmitting within the CAP shall ensure that its transaction is complete before the end of the CAP. If this is not possible, the device shall defer its transmission until the CAP of the following superframe and the remaining of the CAP will be idle state. This inefficiency becomes one drawback of system throughput.
2. New enter user device can only access the base station within CAP. The CAP shall shrink or grow dynamically to accommodate the size of the CFP. Therefore, the number of new enter user devices is limited. This means the new enter user device shall expect long delay to connect to the base station.
3. The base station will not keep track of all user devices' status for every superframe. If one leaves the coverage without any notice and it has been allocated with GTS, base station will keep this useless GTS for several superframe, which becomes another drawback of system throughput. Also, not keeping updates in every superframe can make the scheme not ideal for scenarios requiring high security or continuous tracking.

4.2.3 Proposed COMAC Scheme

We have revealed the contention problem of VLC. From here on, we present our novel MAC scheme which we call it Centralized Optical MAC (COMAC). The fundamental principles are still four-way hand-shaking with backoff mechanism. And, it shares similarities with MAC specifications of 802.15.7 standard so that it is also capable of solving the contention. However, the change of the sequence and more flexibility make the new scheme quite different.

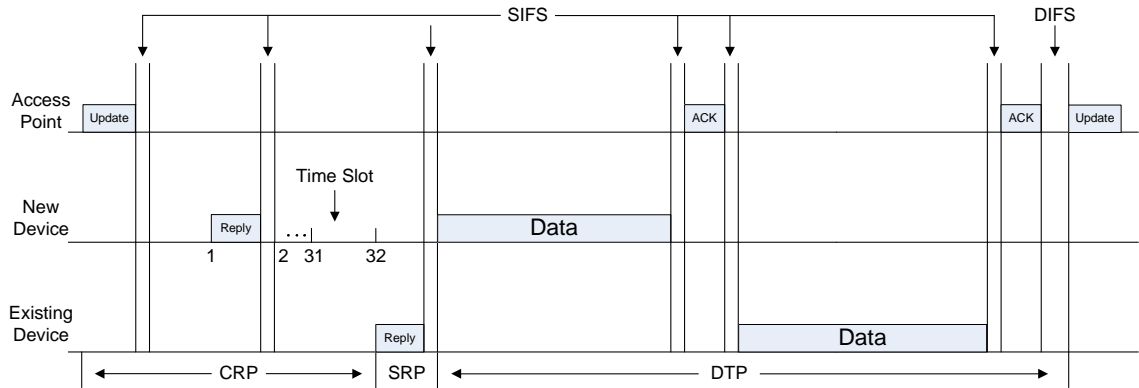

Figure 4-13: An example of one cycle and IFS in it

In COMAC, the access point has more control over the whole procedure. We divide the timeline into cycles, which are initiated by update packets from access points. The procedure is illustrated in Figure 4-13 and can be described as follows:

- Update packet is sent periodically from access point to all users in the coverage at the beginning of each cycle. The packet could also be considered as the beacon for synchronization.
- The next period is called Contention Request Period (CRP), during which only new enter users send back their information to the access point, and no data transmission allowed in it.
- After CRP, the existing users start updating their own information as scheduled. We call this period Slotted Request Period (SRP).
- The last period is Data Transmission Period (DTP), in which every node with transmission task finish one packet respectively with a scheduled sequence controlled by access point.

Similar to 802.15.7 standard, we have overheads such as update packet, reply packets from all user device and ACK packets to separate different data transmission.

These overheads occupy some bandwidth, and sacrifice the throughput for shorten latency as discussed in the performance analysis later in Section 4.2.4.

We can see that COMAC is a combination of random access algorithm and scheduled access algorithm. It has the efficiency for existing users and flexibility to the new users. By providing more control to access point, contention can be greatly reduced. We provide detailed information of COMAC in the following subsections.

CRP

We illustrate the access algorithm in Figure 4-14.

During CRP, new user devices need to compete for service by uploading own information with certain random access algorithm. We adopt the same backoff mechanism here as in CSMA with length w window and backoff factor m . However, considering the new enter users should be a small portion of total users, normally we can choose small w and m . In case a very small m is chosen as happened in the Section 4.2.4, we also need to specify maximum attempt c .

New enter user device will wait for the update packet from base station. No update packet means no service is available. Once update is received, it starts synchronizing with the network, and wait for a back off time to send out its reply to the base station with its information. In the DTP, base station should send back ACK to notify a successful receive of the information from this device. If device does not receive such ACK, it will increase the attempt counter. When maximum attempt is reached, we consider connection procedure fail, and no more attempt unless manually reset the user device. Furthermore, even if ACK is received, there are two results. If connection is guaranteed, this device will be able to inform the base station about the task and start transmission in the following cycles. If not, that means base station refuse to provide service to this device and therefore, it is also considered as connection

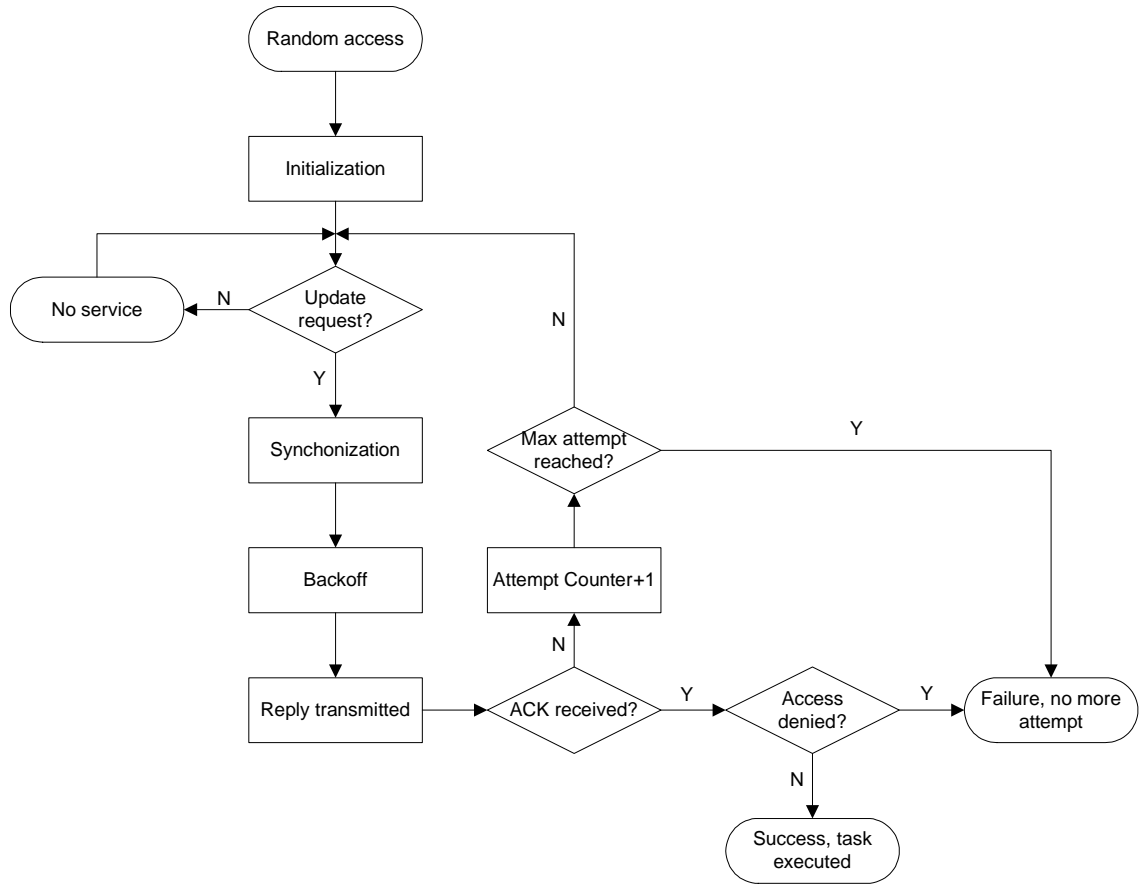

Figure 4-14: New user device's access flow chart

procedure fail.

SRP

We illustrate the access algorithm in Figure 4-15.

SRP starts immediately follow the CRP, and it has to end before the actual DTP. During this period, existing user device should report its status with any possible tasks. The time slot for each device has been pre-allocated during the CRP when the device first entered the coverage. This mechanism can ensure contention-free and improve the channel usage efficiency. Therefore, the length of SRP is flexible and known by the access point, and it could grow or shrink depending on the total

amount of user devices.

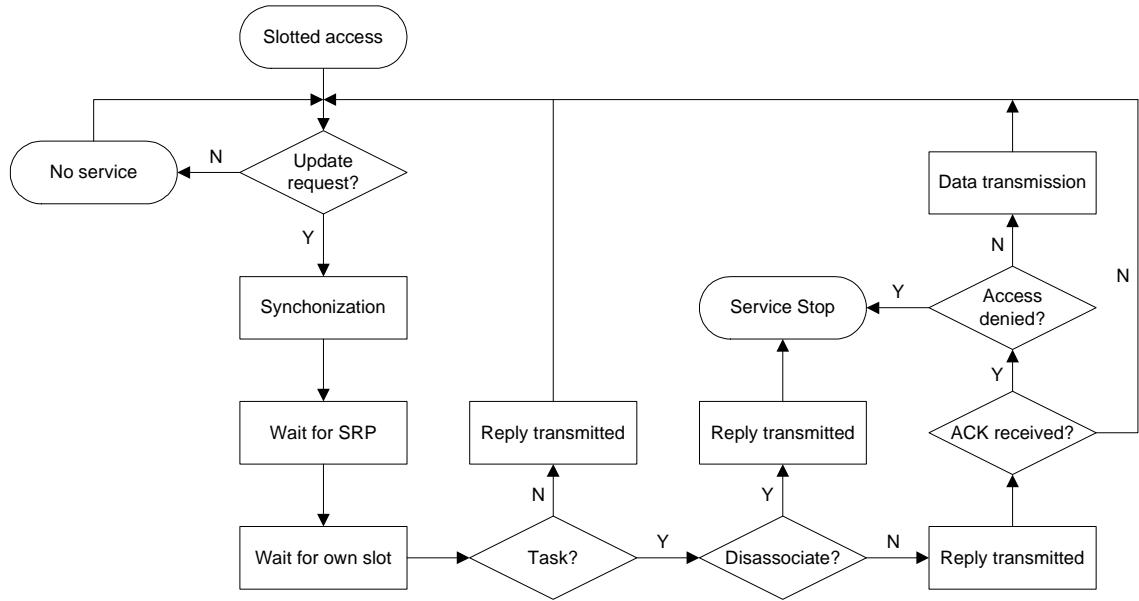

Figure 4-15: Existing user device's access flow chart

Existing user device will also wait for the update packet from base station. No update packet means no service is available. Once update is received, it starts synchronizing with the network and wait for its own slot in the SRP. If it has no transmission request in current cycle, it will only reply back to base station to update its own information. Otherwise, if it wants to disconnect from the service, it will reply the disassociation request. In the third case, if it has a transmission task, it will send back the reply with the transmission request. Similarly, in the DTP, base station should send back ACK to notify a successful receive of the information from this device. If device does not receive such ACK, the device waits for the next cycle. When ACK is successfully received, if access is denied, the device will disconnect and wait for manually reset, otherwise, transmission will be established as requested.

DTP

After SRP, access point will collect information from all replies. It then schedules a transmission task sequence in current cycle, and all tasks will be executed in DTP based on this sequence.

The access point uses ACK contained with command information as guard to separate different user's task and also invoke next user's transmission. The packet length in each task transmission is pre-defined and it can affect the channel efficiency as well as latency performance as indicated in Section 4.2.4.

Inter-frame Spacing (IFS)

The MAC sublayer needs a finite amount of time to process data received by the physical layer. To allow for this, two successive frames transmitted from a device shall be separated by at least an IFS period.

In CSMA, there are two types of IFS, DIFS and SIFS. SIFS is shorter than DIFS, and it follows after RTS, CTS and data packet. DIFS, also the length for channel sensing, is only applied after ACK when channel sensing could occur. Since SIFS is much shorter than DIFS, any nodes not notified by RTS and CTS could still avoid collision by channel sensing.

The IFS and other access mechanisms can also be illustrated in Figure 4-13.

Differences from IEEE 802.15.7 Standard

Both COMAC and MAC of 802.15.7 Standard solving the contention by restraining the random access in a specified period and synchronizing all periods by either update request or beacon. Both schemes provide two methods for accessing the channels. Both schemes provide flexibility on length of each period within the cycle or superframe. However, some differences make them perform differently and suitable

for different applications.

1. In COMAC, the cycle length is not fixed. It depends on how many transmission requests from user devices. In this way, by being acknowledged from user devices in each cycle, COMAC can remove idle states, which therefore increases the throughput.
2. In COAMC, only a short reply packet, without data packet, is needed from user device in CRP. Since new enter user device can only access the channel in CRP, this suggests that the base station is able to accept more new enter user devices, so that the average latency for them will be shorten.
3. In COMAC, the base station will track the status of all user devices under its coverage. The additional reply and control packets will occupy some bandwidth, but on the other hand, can benefit applications required high security.

The Section 4.2.4 will discuss the differences in performance in terms of latency and throughput under different scenarios.

4.2.4 Performance Analysis of MAC Schemes

In this section, we compare the performance among three MAC schemes, COMAC, MAC specification of 802.15.7 standard and original CSMA/CA. Although CSMA/CA is not suitable for our VLC system due to the increased interference, it has been adopted for several wireless standards and therefore can give us performance results over multiple existing wireless techniques. We adopt the same set of parameters defined in Section 4.1.3.

In wireless communication and network, latency and throughput are two important parameters for evaluation. We start with latency analysis of new enter user device.

Latency Comparison

We adopt the same set of parameters defined in Section 4.1.3 for 802.15.7 standard and CSMA/CA. For fairness, the specifications of COMAC are set to be the same as indicated in Table 4.6. For random access mechanism, we consider $W = 32$ and $m = 0$. We also set the number of existing users $N = 20$. This means no matter how many new enter user devices accepted in current superframe or cycle, we consider the same number of user devices will leave the coverage, so that the total amount of data packets transmitted in each superframe or cycle are the same for comparison.

Furthermore, latency problem aggravates with the number of user devices competing for the channel. Therefore, we consider the worst scenario for latency, fully loaded network, where every user device always has a transmission request. Since we consider the same scenario as in Section 4.1.3, (4.1) and (4.2) still hold here and give us a unique pair of results for packet transmission probability, τ , and conditional collision probability, p .

Table 4.6: Time variables definition of COMAC [Bia00]

Payload size	8184 bits
MAC header	272 bits
PHY header	128 bits
ACK	112 bits + PHY header
Update	160 bits + PHY header
Reply	112 bits + PHY header
Propagation delay (δ)	1 μ s
Slot time (σ)	50 μ s
SIFS	28 μ s
DIFS	128 μ s

For any new enter user device, there are two results for each connection attempt, not accepted and accepted. For each attempt with CSMA/CA, we define T_a as the waiting time if user device is accepted, and T_b as the waiting time if not accepted. Similarly, we also define T_h and T_m for COMAC and 802.15.7 standard if accepted,

and T_i and T_n if not accepted. One observation is T_i and T_n are actually the length of cycle and superframe.

$$\begin{aligned} T_a &= \frac{W-1}{2}\sigma + \frac{RTS + CTS}{rate} + 2(SIFS + \delta), \\ T_b &= T_a + \frac{Header + Payload + ACK}{rate} + SIFS + DIFS + 2\delta. \end{aligned}$$

$$\begin{aligned} T_h &= (W-1)\sigma + \frac{Update + Reply}{rate} + 2(SIFS + \delta) + N\sigma, \\ T_i &= T_h + N\left(\frac{Header + Payload + ACK}{rate} + 2(SIFS + \delta)\right) - SIFS + DIFS. \end{aligned}$$

$$\begin{aligned} T_m &= \frac{Beacon}{rate} + \frac{W-1}{2}\sigma + \frac{RTS + CTS}{rate} + 2(SIFS + \delta), \\ T_n &= T_m + \frac{W-1}{2}\sigma + N\left(\frac{Header + Payload}{rate} + 2(SIFS + \delta)\right) - SIFS + DIFS. \end{aligned}$$

When Reply or RTS from user device fails, it will retransmit in the next cycle or superframe. To analyze the latency, in COMAC, let us assume the new enter user is the first one to transmit payload in the DTP. The latency for CSMA/CA is

$$\begin{aligned} L_{CSMA} &= \sum_{t=1}^{\infty} p^{t-1}(1-p)((T_b)t - (T_b - T_a)) \\ &= \frac{pT_b}{1-p} + T_a. \end{aligned}$$

And similarly, we have $L_{COMAC} = \frac{pT_i}{1-p} + T_h$ and $L_{802.15.7} = \frac{pT_n}{1-p} + T_m$.

Therefore, we can compare the latencies among three candidates. Figure 4-16 shows that CSMA/CA is still the best in terms of latency under most cases. Second, when the number of new enter user device grows, the difference between the latencies

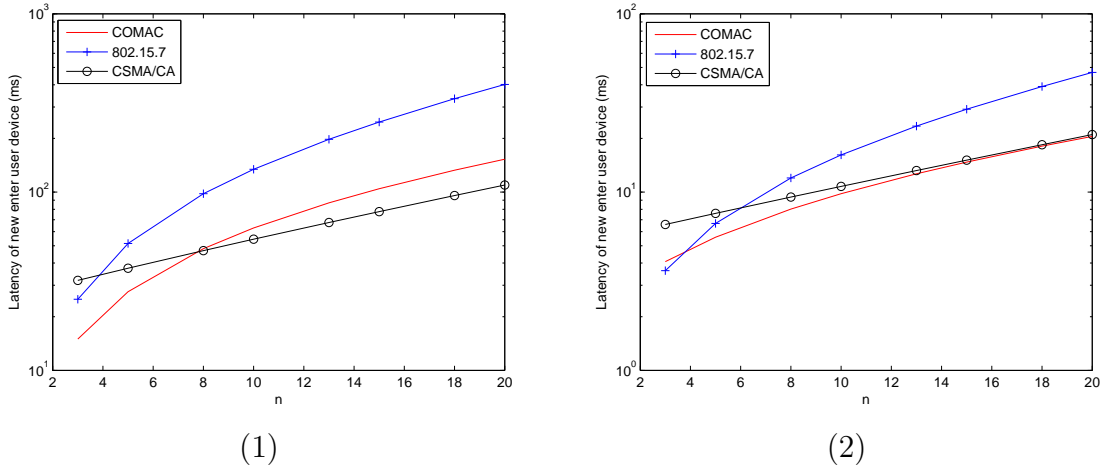

Figure 4-16: Latency comparison with rate of (1) 1 Mb/s and (2) 10 Mb/s for CSMA/CA, COMAC and 802.15.7 standard

of COMAC and 802.15.7 standard becomes larger. For transmission rate of 1 Mb/s and 10 Mb/s, COMAC can reduce the latency up to 62 percent and 56 percent. The reason is that COMAC's advantage of accepting more new devices becomes more obvious when there are more devices competing for the channel. It also shows that, with transmission rate of 1 Mb/s, COMAC can still manage to restrain the latency within 100 ms under most cases, while 802.15.7 standard has latency longer than 100 ms for more than half of the cases.

Throughput Comparison

We first consider the same fully loaded network. Since we know that in every super-frame of 802.15.7 standard, transmission is expected from each user device, maximizing the CFP, which can eliminate most of back off idles and RTS/CTS packets, will benefit system throughput. Therefore, we guarantee the length of CAP can accept one user device, and let the rest of superframe be CFP. Furthermore, since there is no need to consider new enter user device separately, we redefine N as total user devices having transmission during a cycle or superframe.

The normalized system throughput (ratio of transmission for data packets) of CSMA/CA has been discussed in Section 4.1.3 and given as (4.3). However, different from this statistical result, the throughputs of COMAC and 802.15.7 standard are more deterministic mainly due to the fact that a large portion of the cycle works as a scheduled MAC. The normalized system throughputs are defined as

$$S_{comac} = \frac{\frac{Header+Payload}{rate} N}{T_i}, \quad (4.4)$$

$$S_{802.15.7} = \frac{\frac{Header+Payload}{rate} N}{T_n}. \quad (4.5)$$

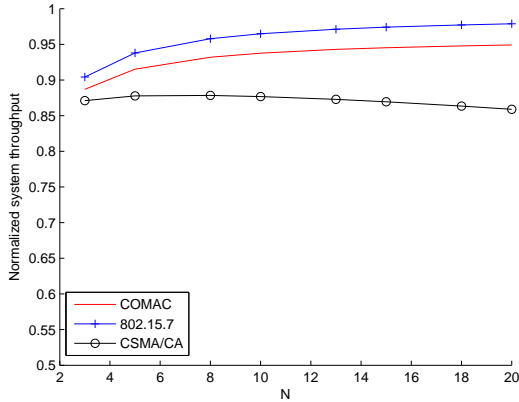

(1)

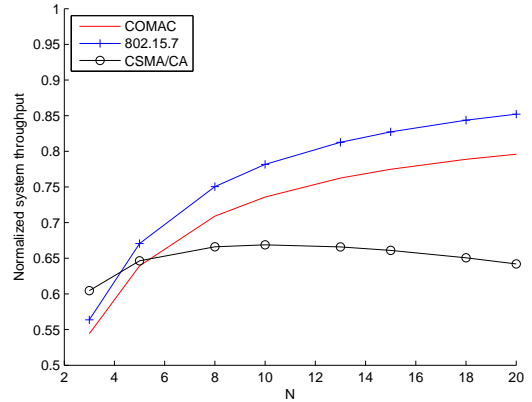

(2)

Figure 4-17: Normalized throughput with rate of (1) 1 Mb/s and (2) 10 Mb/s for CSMA/CA, COMAC and 802.15.7 standard (fully loaded network)

Figure 4-17 illustrates the normalized system rate throughput based on (4.3), (4.5) and (4.5). Both COMAC and 802.15.7 standard perform better in terms of throughput than CSMA/CA. This is because by having SRP and CFP, both are closer to be scheduling MAC scheme. However, in order to reduce latency, COMAC sacrifices up to 6 percent of bandwidth on additional control overheads.

The second scenario we consider is partial loaded network. In other words, user

devices have transmission request with a certain probability. Here we consider the transmission request probability, $R = 3/4$. There are two choices setting the super-frame of 802.15.7 standard, maximizing CAP or maximizing CFP. One observation is when we maximize CAP, the MAC specification becomes CSMA/CA with super-frame. And due to the additional overhead and idle issue we discussed in Section 4.2.2, it cannot outperform CSMA/CA and therefore we only consider maximizing CFP as in the analysis for fully loaded network.

Because of the transmission request probability, we update

$$T_i = T_h + NR \left(\frac{\text{Header} + \text{Payload} + \text{ACK}}{\text{rate}} + 2(\text{SIFS} + \delta) \right) - \text{SIFS} + \text{DIFS},$$

$$\begin{aligned} \tau_{new} &= R\tau, \\ S_{comac} &= \frac{\frac{\text{Header} + \text{Payload}}{\text{rate}} NR}{T_i}, \end{aligned} \quad (4.6)$$

$$S_{802.15.7} = \frac{\frac{\text{Header} + \text{Payload}}{\text{rate}} NR}{T_n}. \quad (4.7)$$

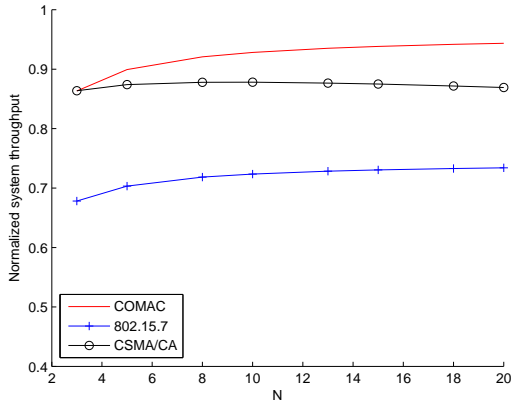

(1)

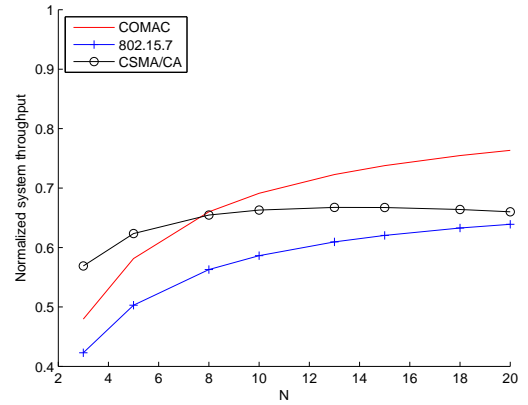

(2)

Figure 4-18: Normalized throughput with rate of (1) 1 Mb/s and (2) 10 Mb/s for CSMA/CA, COMAC and 802.15.7 standard (partial loaded network)

Figure 4-18 illustrates the normalized system throughput based on (4.3), (4.7) and

(4.7). Different from Figure 4-17, we see that COMAC outperforms 802.15.7 standard due to the fact that in the partial loaded network there could be empty GTS that can compromise the system throughput. And such difference is larger for lower data rate.

Conclusion on COMAC

From previous subsections, because COMAC only requires short reply packet in CRP, base station is able to accept more new enter user device. The analysis shows a great reduction of latency comparing to 802.15.7 standard. Regarding to system throughput, 802.15.7 standard slightly beats COMAC in fully loaded network, while COMAC outperforms 802.15.7 standard when user devices don't always have transmission requests.

As a conclusion, combining with the characteristic of keeping each device's status in every cycle, COMAC is good candidate for applications requiring short latency and high security.

4.3 Summary

In this chapter, we present our work on providing a novel multi-hop multi-access VLC solution. Two challenges have been addressed regarding to blocking of service and multiple access contention.

In the first part, we introduce two networking protocols for the LOS problem. From the discussion in previous section, we know that both protocols have advantages and disadvantages. The peer-to-peer protocol leverages a narrow beam and FOV from the proposed device and thereby can have good performance in terms of speed without a central host. The peer-to-host protocol, in contrast, is simpler and easy to implement, but due to the diffuse link model and interference, is less amenable to

high data rates and requires a host to be available.

The adoption of each protocol depends on the desired behavior of the communication model. When the application requires transferring large data, the first protocol is most appropriate. Furthermore, for most of outdoor cases, there is no support from a host that you cannot form a two-layer architecture. So, the first protocol is the only choice. If the application produces short bursts of data or the data rate requirements are relaxed as in many industrial automation scenarios, then the second protocol is a good choice. It is simpler and can readily support mobility of devices. Applications like in-office P2P messaging, in-building location services and the like can use the second protocol.

The second part proposes a novel MAC scheme, called COMAC. VLC systems with multiple mobile users and large coverage need to find a low complexity low cost MAC scheme to solve the challenges like directional signal, high signal attenuation and limited coverage. 802.15.7 standard provides one solution. We propose another solution called COMAC which can shorten the latency by more than 50 percent with about 6 % sacrifice on throughput in fully loaded network comparing to 802.15.7 standard. Furthermore, when user devices do not always have transmission, COMAC will have an improved throughput and even outperform 802.15.7 standard.

Together, we demonstrate that with this novel set of protocols and scheme at networking layer, VLC can overcome two unique and critical challenges without much additional cost. And this work can actually fill an empty research gap of VLC and eventually help any indoor VLC prototypes advance to a much more reliable and practical system providing wireless communication service.

Chapter 5

Conclusion

5.1 Summary

VLC has become a popular research topic in recent years due to the advantages of reduced cost and complexity by combining with illumination, free and higher bandwidth and better security. However, as every frontier technology, it also comes with challenges and problems. In this dissertation, we conduct further researches on modeling the indoor VLC system and analysis on DMT modulation, followed by a novel multi-hop multi-access solution to provide a robust and practical communication system. The significant contributions in this dissertation are summarized below:

1. Indoor VLC Model and DMT Analysis

In Section 3.2, we provide tools to model the indoor scenarios for VLC. By adjusting the parameters of devices, room size, light source location and so on, we are able to predict the certain link performance of indoor VLC systems, such as signal attenuation, BER, rate upper bound and SNR.

In Section 3.3, we present performance analysis on BER and channel capacity. The results show that DMT alone isn't suitable for scenarios with high noise or interference and can outperform OOK only when SNR is high. However, the novel analysis on channel capacity further shows it has much greater potential to reach the maximum based on information theory. OOK can only reach 1 b/s/Hz while DMT can achieve more than 5 b/s/Hz with SNR higher than 40

dB.

2. Networking Protocols

One of the most important characteristics of VLC is signal occlusion of the LOS channels. In Section 4.1.2, we propose two networking protocols to solve the problem by relaying the signal with different strategies. The adoption of each protocol depends on the desired behavior of the communication model. A hexagonal cylinder shape device design is also presented to collaborate with two protocols with comprehensive throughput analysis. Simulations result show that in a 4 user case, considering the rate capacities of devices for uplink and node-to-node transmission to be 2 Mb/s and 10 Mb/s respectively, each user can have an average rate of 422 kb/s for uploading and a total rate over 9 Mb/s giving the transmission on every face of the device a minimum rate in excess of 1.5 Mb/s.

3. Centralized Optical MAC

For any indoor wireless applications, low complexity and cost are always one of the most important characteristics needed to be addressed. However, due to the directional signal and limited coverage provided from each light indoor, a VLC MAC scheme which can solve the additional contention is required, especially when mobility is also taken into consideration.

Our proposed COMAC scheme provides an alternative solution that can solve the collision, and from the discussion in Section 4.2.4, it can shorten the latency by more than 50 percent with about 6 percent sacrifice on throughput in fully loaded network comparing to 802.15.7 standard. Furthermore, when user devices do not always have transmission, it will have an improved throughput and even outperform 802.15.7 standard. The different characteristics make it a

good choice for applications requiring short latency and high security.

5.2 Future Work

VLC is a new and large research area needs to be explored. There are still lots of open challenges. We list several of them which are related to or can be considered as an extension of the works in this dissertation.

1. DMT-OCDMA

CDMA is a much more complex scheme which handles the channel access from the aspect of signaling. As mentioned in Section 2.1.6, the research of it in FSO is quite different from RF due to the optical signal characteristics. The challenge is CDMA is overqualified and too complex for most of indoor applications. However, it is still reasonable to believe that with the development of semiconductor, it will become popular for small wireless scenarios in the future. Integrated with DMT, we can therefore have a powerful signaling solution for VLC.

2. Extension on MIMO

During the discussion in Section 4.1.1, we know that the user device is comprised by several independent faces which can be considered as narrow directional and narrow FOV MIMO transceiver. So, the severe multipath distortion and signal attenuation problems in diffuse link may not be a big concern in the desktop level communication among different user devices. Furthermore, as we all know, the wavelength of optical signal is much smaller which makes each face of the user device into an essential MIMO transceivers. The development of MIMO in our design doesn't need any additional geometry requirements like MSD does. Therefore, exploring MIMO feature on the device can be a good extension of

our research.

3. Implementation Issues

The researches conducted in this dissertation are theoretical. Therefore, implementation work will be one of the future works. COMAC, which does not require any additional support from device design, can be the one to start with. The implementation of COMAC includes several different modules as illustrated in Figure 5.1. Some modules are considered as additional features, and marked in black in the figure.

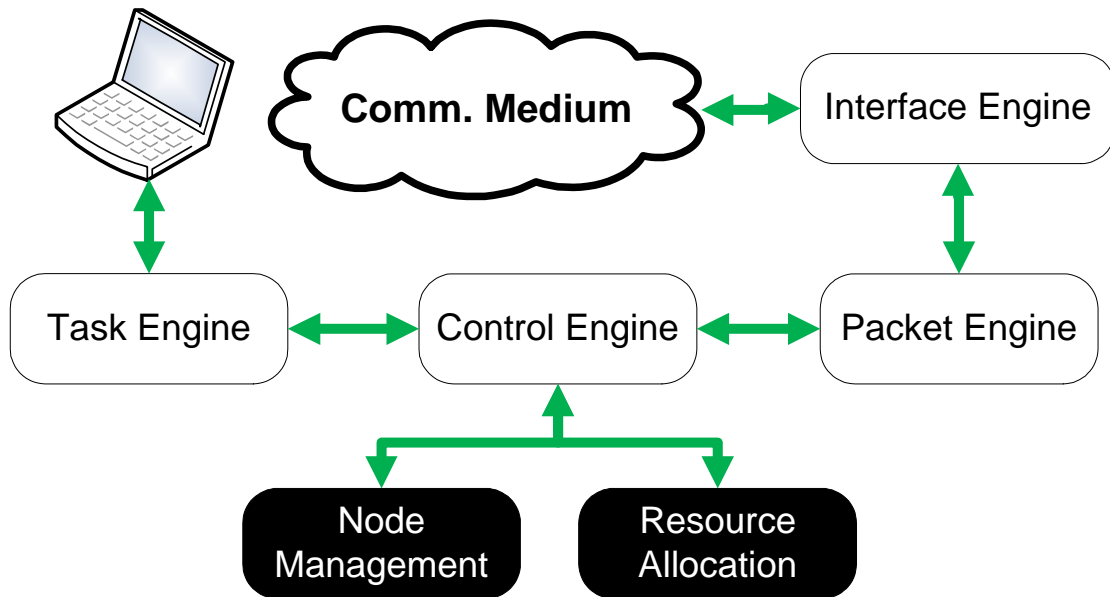

Figure 5.1: Software structure diagram

Furthermore, when the user device described in Section 4.1.1 or similar functionality becomes available, the implementation of networking protocols in Section 4.1.2 can be another future work. Integration with other techniques such as channel coding and modulation is also another important direction needed to be addressed.

References

- [AH95] M. Abtahi and H. Hashemi. Simulation of Indoor Propagation Channel at Infrared Frequencies in Furnished Office Environment. In *6th IEEE International Symposium on Personal, Indoor and Mobile Radio Communications*, volume 1, pages 306–310, September 1995.
- [AK03] Y. Alqudah and M. Kavehrad. MIMO Characterization of Indoor Wireless Optical Link Using a Diffuse-Transmission Configuration. *IEEE Transactions on Communications*, 51(9):1554–1560, September 2003.
- [AK06] P. Amirshahi and M. Kavehrad. Broadband Access Over Medium and Low Voltage Power-Lines and Use of White Light Emitting Diodes for Indoor Communications. In *3rd IEEE Consumer Communications and Networking Conference*, volume 2, pages 897–901, January 2006.
- [AKJ04] Y. Alqudah, M. Kavehrad, and S. Jivkova. Optical Wireless Multi-Spot Diffusing; a MIMO Configuration. In *IEEE International Conference on Communications*, volume 6, pages 3348–3352, June 2004.
- [AL06] J. Armstrong and A. J. Lowery. Power Efficient Optical OFDM. *Electronics Letters*, 42(6):370–372, March 2006.
- [Arn03] S. Arnon. Optical Wireless Communication. In R. G. Driggers, editor, *Encyclopedia of Optical Engineering*, volume 2, pages 1866–1886. Marcel Dekker, September 2003.
- [Ass97] Infrared Data Association. Infrared Data Association Serial Infrared Physical Layer Link Specification, Version 1.2. Technical report, November 1997. http://web.media.mit.edu/~ayb/irx/irda/IrPHY_1_2.PDF.
- [ASWH09] S. An, Y. Son, Y. Won, and S. Han. Visible LED Wireless Optical Transmission in Optical Access Network using Electroabsorption Transceiver. In *Asia Communications and Photonics Conference and Exhibition*, November 2009.
- [ATO10] A. H. Azhar, T.-A. Tran, and D. C. O’Brien. Demonstration of High-Speed Data Transmission Using MIMO-OFDM Visible Light Communications. In *IEEE GLOBECOM Workshops*, pages 1052–1056, December 2010.

- [Bia00] G. Bianchi. Performance Analysis of the IEEE 802.11 Distributed Coordination Function. *IEEE Journal on Selected Areas in Communications*, 18(3):535–547, March 2000.
- [BKK⁺93] J. R. Barry, J. M. Kahn, W. J. Krause, E. A. Lee, and D. G. Messerschmitt. Simulation of Multipath Impulse Response for Indoor Wireless Optical Channels. *IEEE Journal on Selected Areas in Communications*, 11(3):367–379, April 1993.
- [Bou05] A. C. Boucouvalas. Challenges in Optical Wireless Communications. *Optics & Photonics News*, 16(9):36–39, 2005.
- [BPW⁺10] O. Bouchet, P. Porcon, M. Wolf, L. Grobe, J. W. Walewski, S. Nerreter, K.-D. Langer, L. Fernandez, J. Vucic, T. Kamalakis, G. Ntogari, and E. Gueutier. Visible-Light Communication System Enabling 73 Mb/s Data Streaming. In *IEEE GLOBECOM Workshops*, pages 1042–1046, December 2010.
- [BSWG99] J. Bellon, M. J. N. Sibley, D. R. Wisley, and S. D. Greaves. Hub Architecture for Infrared Wireless Networks in Office Environments. *IEE Proceedings Optoelectronics*, 146(2):78–82, August 1999.
- [BYT] BYTELIGHT. www.bytelight.net.
- [Car03] J. B. Carruthers. Wireless Infrared Communications. In J. G. Proakis, editor, *Wiley Encyclopedia of Telecommunications*, volume 5, pages 2925–2931. Wiley-Interscience, January 2003.
- [CCXR10] K. Cui, G. Chen, Z. Xu, and R. D. Roberts. Line-of-Sight Visible Light Communication System Design and Demonstration. In *7th International Symposium on Communication Systems Networks and Digital Signal Processing*, pages 621–625, July 2010.
- [CK96] J. B. Carruthers and J. M. Kahn. Multiple-Subcarrier Modulation for Nondirected Wireless Indoor Infrared Communication. *IEEE Journal on Selected Areas in Communications*, 14(3):538–546, April 1996.
- [CK97] J. B. Carruthers and J. M. Kahn. Modeling of Nondirected Wireless Infrared Channels. *IEEE Transactions on Communications*, 45(10):1260–1268, October 1997.
- [CML10] J. Chau, K. Matarese, and T. D.C. Little. IP-Enabled LED Lighting Supporting Indoor Mobile and Wireless Communications. In *8th Annual International Conference on Mobile Systems, Applications and Services*, June 2010. Poster and Demonstration Session Program.
- [Com93] Commission Electrotechnique Internationale/International Electrotechnical Commission. CEI/IEC 825-1: Safety of Laser Products. Technical report, 1993.

- [Con09] Visible-Light Communication Consortium. Visible Light Communication Physical Layer Specification, Version 1.1. Technical report, August 2009.
- [CSW89] F. R. K. Chung, J. A. Salehi, and V. K. Wei. Optical Orthogonal Codes: Design, Analysis, and Applications. *IEEE Transactions on Information Theory*, 35(3):595–604, May 1989.
- [CYRV02] R. R. Choudhury, X. Yang, R. Ramanathan, and N. H. Vaidya. Using Directional Antennas for Medium Access Control in Ad Hoc Networks. In *8th Annual International Conference on Mobile Computing and Networking*, pages 59–70, September 2002.
- [Dif] Infra-Com. www.infra-com.com.
- [Dou04] T. Douseki. A Batteryless Optical-Wireless System with White-LED Illumination. In *15th IEEE International Symposium on Personal, Indoor and Mobile Radio Communications*, volume 4, pages 2529–2533, September 2004.
- [FK03] K. Fazel and S. Kasier. *Multi-Carrier and Spread Spectrum Systems*. Wiley, November 2003.
- [GLL⁺07] J. Grubor, K.-D. Langer, S. C. J. Lee, T. Koonen, and J. W. Walewski. Wireless High-Speed Data Transmission with Phosphorescent White-Light LEDs. In *33rd European Conference and Exhibition of Optical Communication*, pages 1–2, September 2007.
- [GPJR⁺05] O. Gonzalez, R. Perez-Jimenez, S. Rodriguez, J. Rabadan, and A. Ayala. OFDM Over Indoor Wireless Optical Channel. *IEE Proceedings - Optoelectronics*, 152(4):199–204, August 2005.
- [GRLW08a] J. Grubor, S. Randel, K.-D. Langer, and J. W. Walewski. Bandwidth-Efficient Indoor Optical Wireless Communications with White Light-Emitting Diodes. In *6th International Symposium on Communication Systems, Networks and Digital Signal Processing*, pages 165–169, July 2008.
- [GRLW08b] J. Grubor, S. Randel, K.-D. Langer, and J. W. Walewski. Broadband Information Broadcasting Using LED-Based Interior Lighting. *Journal of Lightwave Technology*, 26(24):3883–3892, December 2008.
- [Har08] S. Haruyama. Japan’s Visible Light Communications Consortium and Its Standardization Activities. mentor.ieee.org/802.15/dcn/08/15-08-0061-00-0_vlc-japan-s-visible-light-communications-consortium-and-its.pdf, 2008.
- [HK06] S. Hranilovic and F. R. Kschischang. A Pixelated MIMO Wireless Optical Communication System. *IEEE Journal of Selected Topics in Quantum Electronics*, 12(4):859–874, July/August 2006.

- [Hos11] T. Hosking. Free Space Optics (Optical Wireless) Global Market Forecast and Analysis. Technical report, ElectroniCast Consultants, May 2011. electronicastconsultants.com/files/FSO_NEWS_RELEASE.May.2011.ElectroniCast.doc.
- [Hra04] S. Hrarilovic. *Wireless Optical Communication System*. Springer, September 2004.
- [HYK⁺94] H. Hashemi, G. Yun, M. Kavehrad, F. Behbahani, and P. Galko. Indoor Propagation Measurements at Infrared Frequencies for Wireless Local Area Networks Applications. *IEEE Transactions on Vehicular Technology*, 43(3):562–576, August 1994.
- [Inf] Infrared Communication Devices. www.mobilecomms-technology.com/projects/irda/irda1.html.
- [Ins93] American National Standards Institute. American National Standard for Safe Use of Lasers (Ansi Z136.1-1993). Technical report, June 1993.
- [IPE⁺08] S. Iwasaki, C. Premachandra, T. Endo, T. Fujii, M. Tanimoto, and Y. Kimura. Visible Light Road-to-Vehicle Communication Using High-Speed Camera. In *IEEE Intelligent Vehicles Symposium*, pages 13–18, June 2008.
- [JHK04] S. Jivkova, B. A. Hristov, and M. Kavehrad. Power-Efficient Multi-Spot-Diffuse Multi-Input-Multi-Output Approach to Broad-Band Optical Wireless Communications. *IEEE Transactions on Vehicular Technology*, 53(3):882–889, May 2004.
- [JVC] JVC. www.jvc-victor.co.jp.
- [Kav07] M. Kavehrad. Broadband Room Service by Light. *Scientific American*, pages 82–87, July 2007.
- [KB97] J. M. Kahn and J. R. Barry. Wireless Infrared Communications. *Proceedings of the IEEE*, 85(2):265–298, 1997.
- [KHNS07] H. Kotake, S. Haruyama, M. Nakagawa, and K. Seki. BER Characteristic of Ground-to-Train Communication System Using Free-Space Optics Technology. In *9th International Conference on Transparent Optical Networks*, volume 3, pages 165–169, July 2007.
- [KJT03] T. Korakis, G. Jakllari, and L. Tassiulas. A MAC Protocol for Full Exploitation of Directional Antennas in Ad-Hoc Wireless Networks. In *4th ACM International Symposium on Mobile Ad Hoc Networking and Computing*, pages 98–107, June 2003.

- [KKC95] J. M. Kahn, W. J. Krause, and J. B. Carruthers. Experimental Characterization of Non-Directed Indoor Infrared Channels. *IEEE Transactions on Communications*, 234(43):1613–1623, February/March/April 1995.
- [KOG70] S. Karp, E. L. O’Neill, and R. M. Gagliardi. Communication Theory for the Free-Space Optical Channel. *Proceedings of the IEEE*, 58(10):1611–1626, October 1970.
- [KS01] A. Keshavarzian and J. A. Salehi. Synchronization of Optical Orthogonal Codes in Optical CDMA Systems via Simple Serial-Search Method. In *IEEE Global Telecommunications Conference*, volume 3, pages 1460–1464, November 2001.
- [KSV00] Y.-B. Ko, V. Shankarkumar, and N. H. Vaidya. Medium Access Control Protocols Using Directional Antennas in Ad Hoc Networks. In *Proceedings. IEEE INFOCOM*, volume 1, pages 13–21, March 2000.
- [LDS⁺08] T. D.C. Little, P. Dib, K. Shah, N. Barraford, and B. Gallagher. Using LED Lighting for Ubiquitous Indoor Wireless Networking. In *IEEE International Conference on Wireless and Mobile Computing, Networking and Communications*, pages 373–378, October 2008.
- [LED] LUXEON Rebel General Purpose White Portfolio. www.philipslumileds.com/pdfs/DS64.pdf.
- [LGB⁺08] K.-D. Langer, J. Grubor, O. Bouchet, M. El Tabach, J. W. Walewski, S. Randel, M. Franke, S. Nerreter, D. C. O’Brien, G. E. Faulkner, I. Neokosmidis, G. Ntogari, and M. Wolf. Optical Wireless Communications for Broadband Access in Home Area Networks. In *10th Anniversary International Conference on Transparent Optical Networks*, volume 4, pages 149–154, June 2008.
- [LIH09] X. Lin, K. Ikawa, and K. Hirohashi. High-Speed Full-Duplex Multiaccess System for LED-Based Wireless Communications Using Visible Light. In *International Symposium on Optical Engineering and Photonic Technology*, July 2009.
- [LMKM08] X. Liu, H. Makino, S. Kobayashi, and Y. Maeda. Research of Practical Indoor Guidance Platform Using Fluorescent Light Communication. *IEICE Transactions on Communications*, E91.B(11):3507–3515, November 2008.
- [LVX] LVX System. www.lvx-system.com.
- [Mat09] T. Matsumura. Channel Models in VLCC. <https://mentor.ieee.org/802.15/dcn/09/15-09-0065-01-0007-channel-models-in-vlcc.pdf>, January 2009.
- [MHK08] Y. Matsumoto, T. Hara, and Y. Kimura. CMOS Photo-Transistor Array Detection System for Visual Light Identification (ID). In *5th International Conference on Networked Sensing Systems*, pages 99–102, June 2008.

- [MK96] G. W. Marsh and J. M. Kahn. Performance Evaluation of Experimental 50-Mb/s Diffuse Infrared Wireless Link Using On-Off Keying with Decision-Feedback Equalization. *IEEE Transactions on Communications*, 44(11):1496–1504, November 1996.
- [MN99] T. Mukai and S. Nakamura. White and UV LEDs. *Oyo Buturi*, 68(2):152–155, 1999.
- [MOF⁺08a] H. Le Minh, D. C. O’Brien, G. E. Faulkner, L. Zeng, K. Lee, D. Jung, and Y. Oh. 80 Mbit/s Visible Light Communications Using Pre-Equalized White LED. In *34th European Conference on Optical Communication*, pages 1–2, September 2008.
- [MOF⁺08b] H. Le Minh, D. C. O’Brien, G. E. Faulkner, L. Zeng, K. Lee, D. Jung, and Y. Oh. High-Speed Visible Light Communications Using Multiple-Resonant Equalization. *IEEE Photonics Technology Letters*, 20(14):1243–1245, July 2008.
- [MOF⁺09] H. Le Minh, D. C. O’Brien, G. E. Faulkner, L. Zeng, K. Lee, D. Jung, Y. Oh, and E. T. Won. 100-Mb/s NRZ Visible Light Communications Using a Postequalized White LED. *IEEE Photonics Technology Letters*, 21(15):1063–1065, August 2009.
- [MOF10] H. Le Minh, D. C. O’Brien, and G. E. Faulkner. A Gigabit/s Indoor Optical Wireless System for Home Access Networks. In *7th International Symposium on Communication Systems Networks and Digital Signal Processing*, pages 532–536, July 2010.
- [Nav] Nautical Marconi Spotlight Navy Signal Lamp Floor Light. <http://cgi.ebay.com/Nautical-Marconi-Spotlight-Navy-Signal-Lamp-Floor-Light-/300447094900>.
- [NUL04] S. M. Navidpour, M. Uysal, and J. Li. BER Performance of MIMO Free-Space Optical Links. In *IEEE 60th Vehicular Technology Conference*, volume 5, pages 3378–3382, September 2004.
- [NYYH00] A. Nasipuri, S. Ye, J. You, and R. E. Hiromoto. A MAC Protocol for Mobile Ad Hoc Networks Using Directional Antennas. In *IEEE Wireless Communications and Networking Conference*, volume 3, pages 1214–1219, September 2000.
- [oEG07] Institute of Electrical and Electronics Engineers WG802.11-Wireless Local Area Networks (WLAN) Working Group. Wi-Fi CERTIFIED 802.11n draft 2.0: Longer-Range, Faster-Throughput Multimedia-Grade Wi-Fi® Networks. Technical report, June 2007. http://www.wi-fi.org/files/kc/WFA_802_11n_Industry_June07.pdf.

- [oEG11] Institute of Electrical and Electronics Engineers WG802.15-Wireless Personal Area Network (WPAN) Working Group. Standard for Short-Range Wireless Optical Communication Using Visible Light. Technical report, April 2011. <http://ieeexplore.ieee.org/stamp/stamp.jsp?tp=&arnumber=5764866>.
- [OFJ⁺06] D. C. O'Brien, G. E. Faulkner, K. Jim, D. J. Edwards, E. B. Zyambo, P. Stavrinou, G. Parry, J. Bellon, M. J. Sibley, R. J. Samsudin, D. M. Holburn, V. A. Lalithambika, V. M. Joyner, and R. J. Mears. Experimental Characterization of Integrated Optical Wireless Components. *IEEE Photonics Technology Letters*, 18(8):977–979, April 2006.
- [OME] OMEGA Project. www.ict-omega.eu.
- [OYY⁺09] S. Okada, T. Yendo, T. Yamazato, T. Fujii, M. Tanimoto, and Y. Kimura. On-Vehicle Receiver for Distant Visible Light Road-to-Vehicle Communication. In *IEEE Intelligent Vehicles Symposium*, pages 1033–1038, June 2009.
- [PG09] J. M. Palmer and B. G. Grant. *The Art of Radiometry*. SPIE Press, December 2009.
- [PHI] LUXEON Rebel White LEDs. www.philipslumileds.com/products/luxeon-rebel/luxeon-rebel-white.
- [Pho] Silicon PIN Photodiode with Very Short Switching Time, SFH 213/SFH 213 FA. <http://rocky.digikey.com/WebLib/Osram/WebData/sfh213fa.pdf>.
- [PKLC02] G. Pang, T. Kwan, H. Liu, and C. Chan. LED Wireless. *IEEE Industry Applications Magazine*, 8(1):21–28, January/February 2002.
- [PL09] G. B. Prince and T. D. C. Little. On the Performance Gains of Cooperative Transmit Beamforming Applied to Intensity Modulated Direct Detection Visible Light Communication Networks. Master's thesis, Boston University, 2009.
- [Pla] Plaintree Systems. www.plaintree.com.
- [Pto] Optical SETI Program. <http://seti.ucolick.org/optical/>.
- [Qaz06] S. Qazi. Challenges In Outdoor and Indoor Optical Wireless Communications. In *International Conference on Wireless Networks*, pages 448–458, June 2006.
- [RGR10] R. Roberts, P. Gopalakrishnan, and S. Rathi. Visible Light Positioning: Automotive Use Case. In *IEEE Vehicular Networking Conference*, December 2010.
- [Ros] Iulian Rosu. Understanding Noise Figure. Technical report, Amateur Radio Community. www.qsl.net/va3iul/Noise/noise.html.

- [RX09] R. Roberts and Z. Xu. Update on VLC Link Budget Work. <https://mentor.ieee.org/802.15/dcn/09/15-09-0635-01-0007-update-on-vlc-link-budget-work.ppt>, September 2009.
- [Sch06] E. F. Schubert. *Light-Emitting Diodes*. Cambridge University Press, June 2006.
- [SHJ05] A. R. Shah, R. C.J. Hsu, and B. Jalali. ISI Equalization for a Coherent Optical MIMO (COMIMO) System. In *Conference on Lasers and Electro-Optics*, volume 2, pages 1348–1350, May 2005.
- [SHN08] T. Saito, S. Haruyama, and M. Nakagawa. A New Tracking Method Using Image Sensor and Photo Diode for Visible Light Road-to-Vehicle Communication. In *10th International Conference on Advanced Communication Technology*, volume 1, pages 673–678, February 2008.
- [Smi98] M. T. Smith. Smart Cards: Integrating for Portable Complexity. *Computer*, 31(8):110–115, August 1998.
- [Smo] Smoke Signal Cartoon. www.cartoonstock.com/newscartoons/directory/s/smoke_signal.asp.
- [SSV⁺10] N. Shrestha, M. Sohail, C. Viphavakit, P. Saengudomlert, and W. S. Mohammed. Demonstration of Visible Light Communications Using RGB LEDs in an Indoor Environment. In *International Conference on Electrical Engineering/Electronics Computer Telecommunications and Information Technology*, May 2010.
- [TAL] Talking Lights. www.talking-lights.com.
- [THN00] Y. Tanaka, S. Haruyama, and M. Nakagawa. Wireless Optical Transmissions with White Colored LED for Wireless Home Links. In *The 11th IEEE International Symposium on Personal, Indoor and Mobile Radio Communications*, volume 2, pages 1325–1329, September 2000.
- [TMRB02] M. Takai, J. Martin, A. Ren, and R. Bagrodia. Directional Virtual Carrier Sensing for Directional Antennas in Mobile Ad Hoc Networks. In *3rd ACM International Symposium on Mobile Ad Hoc Networking and Computing*, pages 183–193, June 2002.
- [TN97] Y. Tanaka and M. Nakagawa. Optical Multi-Wavelength PPM for High Data Rate Transmission on Indoor Channels. In *The 8th IEEE International Symposium on Personal, Indoor and Mobile Radio Communications*, volume 3, pages 979–983, September 1997.
- [TN99] G. Tourgee, G. Nykolak, P. R. Szajowski, and H. Presby. 2.5 Gbit/s Free Space Optical Link Over 4.4km. *Electronics Letters*, 35(7):578–579, April 1999.

- [TO04] D. Takase and T. Ohtsuki. Optical Wireless MIMO Communications (OMIMO). In *IEEE Global Telecommunications Conference*, volume 2, pages 928–932, November/December 2004.
- [UYS⁺08] H. Uchiyama, M. Yoshino, H. Saito, M. Nakagawa, S. Haruyama, T. Kakehashi, and N. Nagamoto. Photogrammetric System Using Visible Light Communication. In *34th Annual Conference of the IEEE Industrial Electronics*, pages 1771–1776, November 2008.
- [VFK⁺10] J. Vucic, L. Fernandez, C. Kottke, K. Habel, and K.-D. Langer. Implementation of a Real-Time DMT-Based 100 Mbit/s Visible-Light Link. In *36th European Conference and Exhibition on Optical Communication*, pages 1–5, September 2010.
- [VKN⁺09a] J. Vucic, C. Kottke, S. Nerreter, A. Buettner, K.-D. Langer, and J. W. Walewski. White Light Wireless Transmission at 200+ Mb/s Net Data Rate by Use of Discrete-Multitone Modulation. *IEEE Photonics Technology Letters*, 21(20):1511–1513, October 2009.
- [VKN⁺09b] J. Vucic, C. Kottke, S. Nerreter, K. Habel, A. Buettner, K.-D. Langer, and J. W. Walewski. 125 Mbit/s over 5 m Wireless Distance by Use of OOK-Modulated Phosphorescent White LEDs. In *35th European Conference on Optical Communication*, pages 1–2, September 2009.
- [VKN⁺10a] J. Vucic, C. Kottke, S. Nerreter, K. Habel, A. Buettner, K.-D. Langer, and J. W. Walewski. 230 Mbit/s via a Wireless Visible-Light Link based on OOK Modulation of Phosphorescent White LEDs. In *Conference on Optical Fiber Communication, collocated National Fiber Optic Engineers Conference*, pages 1–3, March 2010.
- [VKN⁺10b] J. Vucic, C. Kottke, S. Nerreter, K.-D. Langer, and J. W. Walewski. 513 Mbit/s Visible Light Communications Link Based on DMT-Modulation of a White LED. *Journal of Lightwave Technology*, 28(24):3512–3518, December 2010.
- [VLC] Visible Light Communications Consortium. www.vlcc.net.
- [WBPCLO5] S. G. Wilson, M. Brandt-Pearce, Q. Cao, and J. Leveque. Free-Space Optical MIMO Transmission With Q-ary PPM. *IEEE Transactions on Communications*, 53(1):204, January 2005.
- [WCL11] Z. Wu, J. Chau, and T. D.C. Little. Modeling and Designing of a New Indoor Free Space Visible Light Communication System. In *16th European Conference on Networks and Optical Communications*, pages 80–83, July 2011.
- [WE00] K. Wilson and M. Enoch. Optical Communications for Deep Space Missions. *IEEE Communications Magazine*, 38(8):134–139, August 2000.

- [WYFT05] M. Wada, T. Yendo, T. Fujii, and M. Tanimoto. Road-to-Vehicle Communication Using LED Traffic Light. In *IEEE Intelligent Vehicles Symposium*, pages 601–606, June 2005.
- [YAKD09] M. Yuksel, J. Akella, S. Kalyanaraman, and P. Dutta. Free-Space-Optical Mobile Ad Hoc Networks: Auto-Configurable Building Blocks. *ACM/Springer Wireless Networks*, 15(3):295–312, April 2009.
- [YCZ⁺09] Y. Yang, X. Chen, L. Zhu, B. Liu, and H. Chen. Design of Indoor Wireless Communication System Using LEDs. In *Asia Communications and Photonics Conference and Exhibition*, November 2009.
- [ZOM⁺08] L. Zeng, D. O’Brien, H. Le Minh, K. Lee, D. Jung, and Y. Oh. Improvement of Data Rate by Using Equalization in an Indoor Visible Light Communication System. In *4th IEEE International Conference on Circuits and Systems for Communications*, pages 678–682, May 2008.

CURRICULUM VITAE

Zeyu Wu

Zeyu Wu was born in 1980 in Wuhan, China. He received the Bachelor of Engineering degree in Telecommunication Engineering, Huazhong University of Science and Technology, Wuhan, China in 2003 and Master of Science degree in Mathematics from University of New Orleans in 2006. At Boston University, he was awarded Graduate Research Assistantship in 2008-2011.

Mr. Wu worked for Shleton Technologies R&D Center, Wuhan, China in 2003. He designed and implemented Non-contact IC card system for building security. In summer 2007, he worked for Deutsche Telekom Laboratories where he participated in the heterogeneous access networks project. In fall 2007, he worked with the group of Simulink and Real-Time Workshop at The Mathworks Inc., Natick, MA. He developed Matlab and C++ test programs for various components included in MATLAB Ver. 2008a.

Mr. Wu has authored several conference and journal papers. He has served as reviewer for journals and conferences and also as technical program committee (TPC) member for conferences. He is a student member of the IEEE. He can be reached at the following address:

Zeyu Wu
ECE Department
Boston University
8 Saint Mary's Street
Boston, MA 02215
Email: bobtail@bu.edu